

CLEAN ROOM PANEL - CRP5

RELIABLE MEASUREMENTS IN CLEAN ROOMS

- Measures differential pressure, humidity and temperature
- Designed specifically for clean rooms
- Removable humidity and temperature probes for simpler adjustment and cleaning
- FDA- and GAMP-compatible
- Digital communication via Ethernet RJ45 and/or MODBUS TCP / RTU
- Analog input and output signals freely configurable
- Glass front panel highly resistant to chemicals
- Optical operating elements for operation with protective gloves



CLEAN ROOM PANEL - CRP5

TAKE A CLOSE LOOK: THE MAIN ADVANTAGES AT A GLANCE.

The Clean Room Panel, which is fitted with a diaphragm sensor for differential-pressure measurement, is a top-quality device. Validated according to GMP directives, and with its well thought-out design, the CRP5 is optimized for applications in laboratories and clean rooms. Optical buttons, and the magnet-mounted, removable HC2-CRP humidity and temperature probe permit efficient and effective cleaning. Up to 6 measurement values and messages can be displayed via its graphical color display. The colors of the display can be adjusted individually. Alarms, such as faults, exceeded limit values, or warnings are highlighted on the CRP5 display, and can also be forwarded digitally via MODBUS, Ethernet, or relays. Thanks to its analog and digital communication capabilities, the CRP5 is very easy to integrate in any monitoring system. Its comprehensive functional capabilities allow the CRP5 to be configured perfectly for each application. The CRP5 is distinctive in the marketplace through its tough glass front plate and a removable humidity sensor.

Proven housing

- Robust, resistant glass front plate
- Protection Class IP65
- Installation in the wall of the clean room

Functional display

- Measurement values displayed on a color graphics display with trend indicator and alarm signaling
- Configuration possible via 4 optical buttons

Power supply

- 20...48 VDC / 18...35 VAC

Communication

- 4 analog outputs: freely allocatable and scalable
- 2 analog inputs
- 2 digital inputs
- Ethernet RJ45; MODBUS TCP / RTU
- 6 solid-state relays

Interchangeable probe

- Removable humidity and temperature probe HC2-CRP
- Simple probe calibration outside the room being monitored
- Alternatively: External HygroClip2 probe for detached humidity and temperature measurement



THE APPLICATIONS

The CRP5 clean-room panel is the obvious choice wherever a high degree of cleanliness is vital, in addition to precise measurement of differential pressure, humidity, and temperature. The CRP5 is used particularly in clean-rooms in hospitals, in the pharmaceutical, electronics, and foodstuffs industries, and wherever small variances in pressure are monitored. The very comprehensive functional capabilities of the CRP5 provide solutions for many measurement and control tasks.



THE PROBES FOR THE CRP5.

The HygroClip2 is available in various versions. From simple standard probes up to highly developed cable probes for high-temperature or other special applications, you will find exactly the probe that you need in our product range. What they all have in common is the high precision, reliability, and long-term stability that individual adjustment assures. And that is precisely what makes each probe in our range a high-end product for normal and industrial applications.

Clean-room probe HC2-CRP



Precision: $\pm 1.5\%RH$
Range of application: $-5...60^{\circ}C$
Probes in stainless steel
Magnetic attachment to the CRP5



Any Rotronic probe



Precision: up to $\pm 0.5\%RH$
Range of application: $-100...200^{\circ}C$
Plastic, stainless-steel
and screw-in versions
Screw connection via Rotronic E2 plug



Would you like more information (special applications, ordering codes, etc.) on the choice of the correct probe?
You will find a complete and always up-to-date overview of all our probes at our web site www.rotronic.com.

TECHNICAL INFORMATION

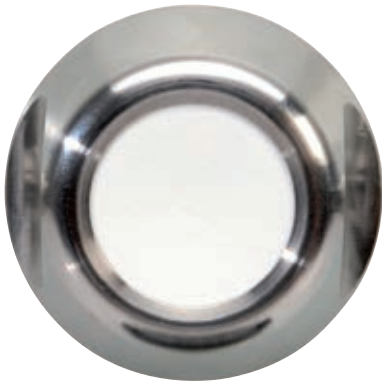

HC2-CRP

Clean-room probe HC2-CRP

Range of application	-5...60 °C / 0...100 %RH
Precision @ 23 °C ±3 K	±1.5 %RH / ±0.2 K
Power supply	3.3...5 VDC
Current consumption	3.5 mA
Long-term stability	<1 %RH / year
Sensor	HYGROMER® WA-1
Filtertype	Teflon, 5 µm
Response time	49 s
Connection	Spring contacts gold plated
Housing material	Stainless steel 1.4301 / PEEK
Weight / Protection type	155 g / IP65



HC2-CRP-HOLDER

Holder HC2-CRP HOLDER

Range of application	-5...60 °C / 0...100 %RH
Connection	Gold contacts / PicoBlade
Housing material	PEEK
Protection type	IP65



AC6102

ER-CRP

Accessories

Assembly accessories

2 off Wall bracket	AC6101
4 off PEEK screws	AC6102
Service cable	AC3006 (requires HW4 software)
Covers, pressure connections	AC6100 (without hole) AC6100 (with hole)
Calibration jig	ER-CRP
Calibration jig for HygroGen2	ER-CRP-HG2
Cable 10cm, open end	PB-15-PB
Cable A for PicoBlade	A-80-PB
Teflon filter	SP-CRP

TECHNICAL INFORMATION.

Technical drawings, CRP5

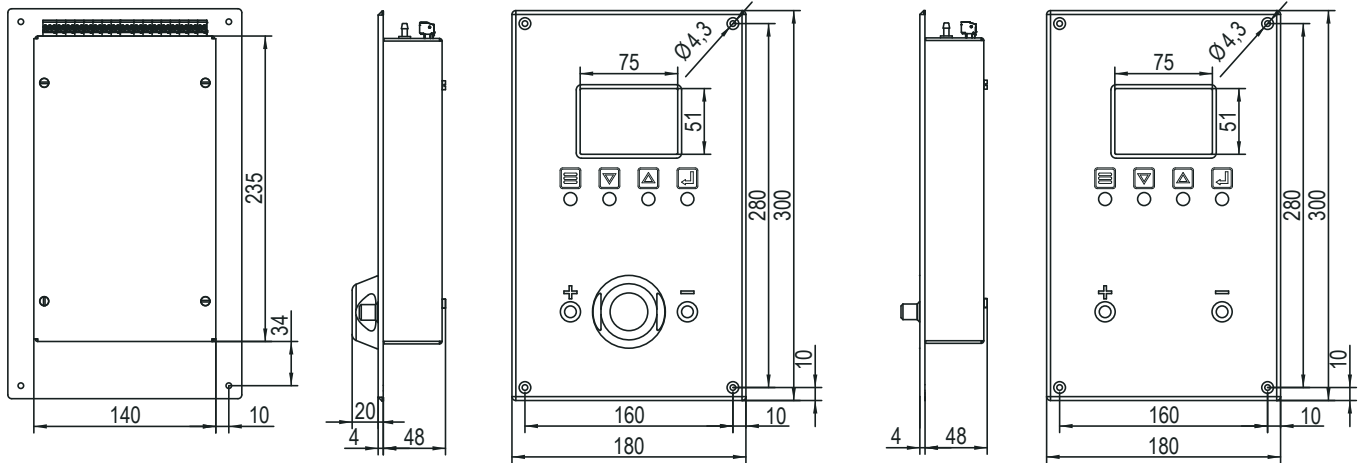

With front-mounted probe HC2-CRP

With HygroClip2 connection on back

HC2-CRP

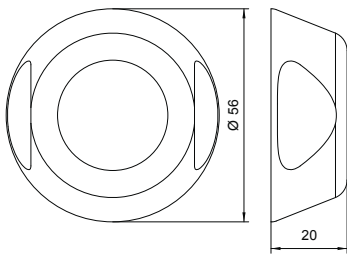

HC2-CRP Holder

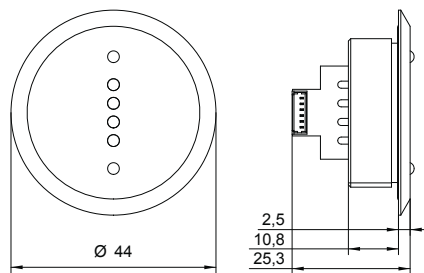

CRP Wall Bracket

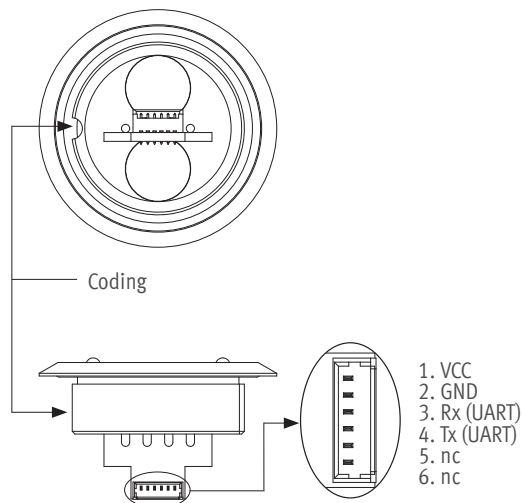
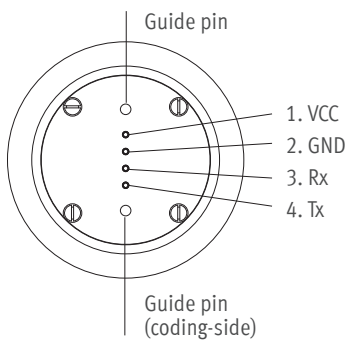
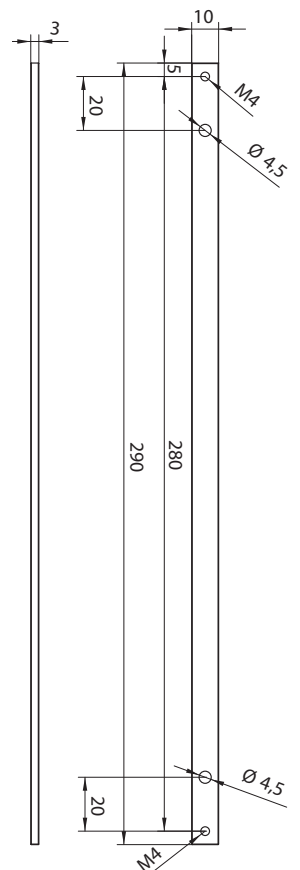

TECHNICAL DATA.

General	
Parameters	Differential pressure, temperature, relative humidity, digital and analog inputs
Housing material	Front: Glass Back: Stainless Steel
IP protection	Front: IP65 (also with sensors removed) Back: IP20
Mounting position	Wall Mounting
Display	Color TFT display
Menu Navigation	4 optical buttons
Electrical connections	Screw terminals on back
Power supply	20...48 VDC / 18...35 VAC
Current Consumption	<500 mA
Range of application / Storage conditions	-5...60 °C (23...140 °F) / 0...100%RH
Firmware update	via HW4 software
Service interface	UART
CE / EMC compatibility	EMC Directive 2004/108/EC
Fire protection class	Corresponds to UL94-HB
FDA- / GMP compatible	21 CFR Part 11 and GAMP5
Dimensions	180x300x72 mm
Weight	1,700 g (with humidity sensor) 1,550 g (without humidity sensor)
Differential Pressure Measurement	
Measurement principle	Diaphragm sensor
Measurement ranges	±50 Pa / ±100 Pa / ±250 Pa / ±500 Pa
Medium	Air and non-aggressive gases
Accuracy at 23 °C ±3 K	±1.0 % full-scale
Zero drift	Compensated (manual or automatic zero adjustment)
Measurement interval	1 s
Pressure resistance	0.7 bar (70,000 Pa)
Pressure connections	Front: Hose connectors Ø 6 mm x 10 mm Back: Hose connectors Ø 4 mm x 10 mm
Temperature measurement / Relative-humidity measurement	
Probes	HC2-CRP; alternatively: any HygroClip2 probe
Measurement range	-100...200 °C (probe-dependent) / 0...100 %RH
Outputs	
Analog outputs	4, freely configurable
Analog output type	0 / 4...20 mA or 0...1 / 5 / 10 V
Switch output	6 solid-state relays
Switching capacity	<50 VDC at <2 A when observing polarity <35 VAC at <1 A, irrespective of polarity
Accuracy, analog output	±5 mV (voltage output) ±20 µA (current output)
Permissible load	>10 kΩ (voltage output) <500 Ω (current output)
Digital communication	Ethernet (Modbus TCP, HW4) / RS-485 (Modbus RTU, HW4)

Technical changes, errors and omissions reserved at all times