

DATA SHEET

HQ 210

Thermo-hygrometer-air quality



Interchangeable modules
1 device = several possible ranges & parameters



Wireless connection
Device/probe wireless connection



SMART-2014 system
Wireless & wired probes automatically recognized







Supplied with calibration certificate

Features

- Hygrometry, temperature, CO₂ & CO gases and air velocity measurement (depending on models)
- Up to 6 measurements simultaneously
- 2 inputs for Pt100 temperature (from -200 to +600°C)
- Large graphic display

References

Reference	Description
 HQ 210	Portable instrument only
 HQ 210 STD	HQ210 + SHR 110 probe (temperature/hygrometry probe in ABS)
 HQ 210 P	HQ210 + SCOH 112 probe (temperature/hygrometry/CO2 probe)
 HQ 210 HT	HQ210 + SHR 300 probe (temperature/hygrometry in stainless steel)
 HQ 210 O	HQ210 + SOM 900 probe (omnidirectional probe of draught)

The probes use a mini-DIN cable unique and pluggable that fits on every probes. Each device is supplied with 2 cables of this type.

The instruments are supplied in a transport case with a calibration certificate, a charger and a USB cable.



HQ 210 General features

Connections	2 mini-DIN connections SMART-2014 probes and 1 micro-USB port for charging and PC connection
Power supply	Lithium-Ion battery
Autonomy	57 h with hygrometry probe
Memory capacity	Up to 1000 dataset of 20 000 points
Conditions of use (°C/%RH/m)	From 0 to +50°C. In non-condensing condition. From 0 to 2000 m.
Storage temperature	From -20 to +80°C
Auto shut-off	Adjustable from 15 to 120 minutes or Off
Weight	485 g
Operating environment	Neutral gas
European directives	2014/30/EU EMC; 2014/35/EU Low Voltage; 2011/65/EU RoHS II; 2012/19/EU WEEE
Languages	French, English, Dutch, German, Italian, Portuguese, Swedish, Norwegian, Finn, Danish, Chinese, Japanese

Operating principle

Non dispersive infrared absorbance

A gas absorbs light at a specific wavelength, some of the intensity emitted by the infrared source absorbed by the gas sample. The amount of light read by the IR sensor is inversely proportional to CO₂ concentration.

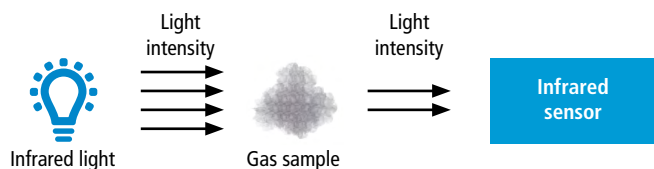

Electrochemical sensor

Electrochemical cell consists of a container, 2 electrodes, connection wires and an electrolyte. Carbon monoxide is oxidised at one electrode to CO₂ whilst oxygen is consumed at the other electrode. The current produced is proportional to CO concentration

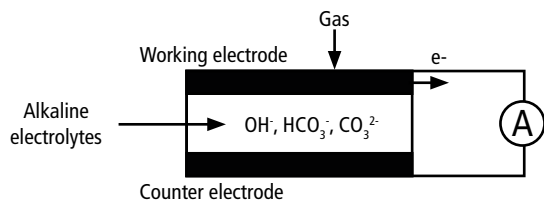

Maintenance

We carry out calibration, adjustment and maintenance of your devices to guarantee a constant level of quality of your measurements. As part of Quality Assurance Standards, we recommend you to carry a yearly checking.

Warranty

Devices have 1-year guarantee for any manufacturing defect (return to our After-Sales Service required for appraisal).

Precautions for use

Please always use the device in accordance with its intended use and within parameters described in the technical features in order not to compromise the protection ensured by the device.

Dimensions (in mm)

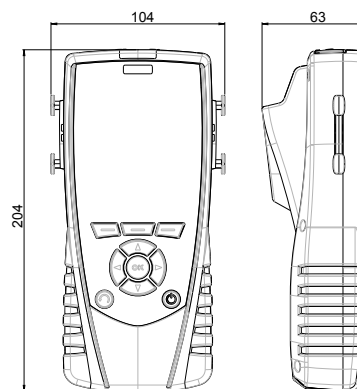

Housing features

Material	ABS/PC and elastomer
Protection	IP54
Display	LCD 120 x 160 px Dimensions: 58 x 76 mm Backlight Display of 6 measurements including 3 simultaneously
Keypad	Elastomer 10 keys

Accessories

Name	Reference
PC software for data recording and processing	Datalogger
Mini-DIN / mini-DIN cable for probe	CSM
Backpack	SAD
Infrared printer	KIMP23
Telescopic extension of 1m length bent at 90° for measuring probe	RTE
Wheeled telescopic tripod for radiofrequency probes, 1.20 to 3.50 m length, ajustable at 90°	RTR-3500



Only the accessories supplied with the device must be used.

Specifications of probes

Probe	Units	Measuring range	Accuracy*	Resolution
Hygrometry probes SHR 110 and SHR 300	Relative humidity: %RH	From 3 to 98% RH	Accuracy (Repeatability, linearity, Hysteresis): ±1.5%RH (from 15°C to 25°C) Factory calibration uncertainty: ±0.88% RH Temperature dependence: ±0.04 x (T-20) %RH (if T<15°C or T>25°C)	0.1% RH
	Absolute humidity***: g/m ³	From 0 to 600 g/m ³	-	0.1 g/m ³
	Dew-point***: °C _{td} , °F _{td}	From -50 to +100 °C _{td}	±0.6% of reading ±0.5 °C _{td}	0.1 °C _{td}
	Wet temperature***: °C _{tw} , °F _{tw}	From -50 to +100 °C _{tw}	±0.6% of reading ±0.5 °C _{td}	0.1 °C _{tw}
	Enthalpy***: kJ/kg	From 0 to 10 000 kJ/kg	-	0.1 kJ/kg
	Temperature: °C, °F	From -20 to +80 °C (SHR110) From -40 to +180 °C (SHR 300)	±0.3% of reading ±0.25 °C	0.1 °C
	Combination ratio***: g/kg	From 0 to 10 000 g/kg	-	0.1 g/kg
Omnidirectional probe of airstream SOM 900	Air velocity: m/s, fpm, km/h	From 0.00 to 5.00 m/s	±3% of reading ±0.05 m/s	0.01 m/s
	Relative humidity: %RH	From 5 to 95% RH	Accuracy (Repeatability, linearity, Hysteresis): ±1.5%RH (from 15°C to 25°C) Factory calibration uncertainty: ±0.88% RH Temperature dependence: ±0.04 x (T-20) %RH (if T<15°C or T>25°C)	0.1% RH
	Temperature: °C, °F	From -20 to +80 °C	±0.3% of reading ±0.25 °C	0.1 °C
CO ₂ /hygrometry/ temperature probe SCOH 112	Temperature: °C, °F CO ₂ : ppm	From -20 to +80 °C From 0 to 5000 ppm	±0.3% of reading ±0.25 °C ±3% of reading ±50 ppm Accuracy (Repeatability, linearity, Hysteresis): ±1.5%RH (from 15°C to 25°C) Factory calibration uncertainty: ±0.88% RH Temperature dependence: ±0.04 x (T-20) %RH (if T<15°C or T>25°C)	0.1 °C 1 ppm 0.1% RH
	Hygrometry: %RH	From 5 to 95% RH		

HQ 210 instruments can also calculate and display the **WBGT index** that corresponds to an index of composite temperature used to estimate the effect of temperature, humidity and solar radiation on humans.

It is calculated from the following temperatures:

- T_w = Wet-bulb temperature or natural wet temperature, measurement calculated from the relative humidity of a thermo-hygro probe;
- T_g = Globe temperature, measured with a globe thermometer, or black globe thermometer, whose sensitive element is in black glass or black-smoke coated in order to run approximatively as a black body to measure the solar radiation. The measurement is performed with a temperature probe placed in a black ball;
- T_a = Air temperature (measured by a thermometer whose bulb is protected from the solar radiation by a screen). The temperature measurement is realised with a thermo-hygro probe;

HQ 210 instruments have the following functions for the measurement of temperature, hygrometry and air quality:

- **Air Quality probes (CO / temperature, CO₂ / temperature, CO₂ / temperature / hygrometry):**
Audible alarm (2 setpoints), Selection of units, Hold function, minimum and maximum values
- **Thermocouple module:**
Delta T, Alarm (lower and upper setpoints), Selection of units, Hold function, minimum and maximum values

*All accuracies indicated in this document were stated in laboratory conditions and can be guaranteed for measurements carried out in the same conditions, or carried out with calibration compensation.

**Calculated parameters.

Delivery kits and options

✓ supplied with

Description	HQ 210	HQ 210 STD	HQ 210 HT	HQ 210 P	HQ 210 O
Telescopic omnidirectional probe (SOM 900)	Optional	Optional	Optional	Optional	✓
ABS hygrometry probe (SHR 110)	Optional	✓	Optional	Optional	Optional
Stainless steel hygrometry probe (SHR 300)	Optional	Optional	✓	Optional	Optional
CO / temperature probe (SCO 110)	Optional	Optional	Optional	Optional	Optional
CO ₂ / temperature probe (SCO 112)	Optional	Optional	Optional	Optional	Optional
CO ₂ / temperature / hygrometry probe (SCOH 112)	Optional	Optional	Optional	✓	Optional
Light probe (SLU)	Optional	Optional	Optional	Optional	Optional
Pt100 SMART-2014 probe	Optional	Optional	Optional	Optional	Optional
Pt100 wireless probe	Optional	Optional	Optional	Optional	Optional
4 thermocouple channels module (M4TC)	Optional	Optional	Optional	Optional	Optional
Climatic conditions module (MCC)	Optional	Optional	Optional	Optional	Optional
Wireless hygrometry probe in ABS (SHRF 110)	Optional	Optional	Optional	Optional	Optional
Wireless stainless steel hygrometry probe (SHRF 300)	Optional	Optional	Optional	Optional	Optional
K, J, N, T and S thermocouple probe	Optional	Optional	Optional	Optional	Optional
Calibration certificate	Optional	✓	✓	✓	✓
Transport case	✓	✓	✓	✓	✓
Additional battery	Optional	Optional	Optional	Optional	Optional

Available probes and modules (optional)



Light probe (SLU)
Measuring ranges from 0 to 150 000 lux
and from 0 to 13935 fc



4 thermocouple channels module (M4TC)
Measuring range from -200 to +1760°C
(according to thermocouple type)



Climatic conditions module (MCC)
Measuring ranges from 0 to +50°C,
from 800 to 1100 hPa and from 5 to 95% RH

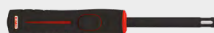

Wireless hygrometry probe (SHRF 110)
Measuring ranges from 3 to 98% RH,
from -50 to +100°C_{td} and from -20 to +80°C



High temperature wireless hygrometry probe (SHRF 300)
Measuring ranges from 3 to 98% RH, from -50 to
+100°C_{td} and from -40 to +180°C



Black ball (BN)



Large choice of temperature probes (see related datasheet): ambient / contact / penetration / immersion...