

DATA SHEET

# VT 210

## Thermo-hygrometer-anemometer



**Interchangeable modules**  
1 device = several possible ranges & parameters



**Wireless connection**  
Device/probe wireless connection



**SMART-2014 system**  
Wireless & wired probes automatically recognized









**Supplied with calibration certificate**

### Features

- Temperature, hygrometry and air velocity measurement (depending on models)
- Up to 6 measurements simultaneously
- 2 inputs for Pt100 temperature (from -200 to +600°C)
- Large graphic display

### References

Reference	Description
 VT 210	Portable instrument only
 VT 210 L VT 210 TL	VT210 + SH100 probe (Ø100 mm vane probe of air velocity, airflow and temperature) VT210 + SHT100 probe (Ø100 mm telescopic vane probe of air velocity, airflow and temperature)
 VT 210 M	VT210 + SMT 900 probe (telescopic multifunction probe of air velocity, airflow, relative humidity and temperature)
 VT 210 P VT 210 TP	VT210 + SH14 probe (Ø14 mm vane probe of air velocity, airflow and temperature) VT210 + SHT14 probe (Ø14 mm telescopic vane probe of air velocity, airflow and temperature)
 VT 210 H VT 210 TH	VT210 + SH70 probe (Ø70 mm vane probe of air velocity, airflow and temperature) VT210 + SHT70 probe (Ø70 mm telescopic vane probe of air velocity, airflow and temperature)
 VT 210 F VT 210 TF	VT210 + SFC300 probe (hotwire probe) VT210 + SFC900 probe (hotwire telescopic probe)

The probes use a mini-DIN cable unique and pluggable that fits on every probes. Each device is supplied with 2 cables of this type\*.

The instruments are supplied in a transport case with a calibration certificate, a charger and a USB cable.



\*Except VT210F and VT210P supplied with 1 cable.

## VT 210 General features

Connections	2 mini-DIN connections SMART-2014 probes and 1 micro-USB port for charging and PC connection
Power supply	Lithium-Ion battery
Autonomy	44 h with hot wire probe 65 h with thermocouple module
Memory capacity	Up to 1000 dataset of 20 000 points
Conditions of use (°C/%RH/m)	From 0 to +50°C. In non-condensing condition. From 0 to 2000 m.
Storage temperature	From -20 to +80°C
Auto shut-off	Adjustable from 15 to 120 minutes or Off
Weight	485 g
Operating environment	Neutral gas
European directives	2014/30/EU EMC; 2014/35/EU Low Voltage; 2011/65/EU RoHS II; 2012/19/EU WEEE
Languages	French, English, Dutch, German, Italian, Portuguese, Swedish, Norwegian, Finn, Danish, Chinese, Japanese

## Operating principle

### Hotwire anemometer

A wire is continuously heated at a superior temperature than ambient and continuously cooled by airflow. Constant temperature is maintained by a regulation circuit. The heating current is proportional to the airflow velocity.

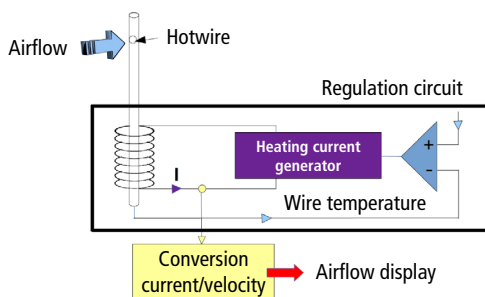

### Thermometer: Pt100 probe

Pt100 is a resistance with a positive temperature coefficient which varies according to the temperature. The higher the temperature is, the more the value of the resistance increases.

i.e: for 0 °C  $\approx$  100  $\Omega$  - for 100 °C  $\approx$  138,5  $\Omega$ .

## Maintenance

We carry out calibration, adjustment and maintenance of your devices to guarantee a constant level of quality of your measurements. As part of Quality Assurance Standards, we recommend you to carry a yearly checking.

## Warranty

Devices have 1-year guarantee for any manufacturing defect (return to our After-Sales Service required for appraisal).

## Precautions for use

Please always use the device in accordance with its intended use and within parameters described in the technical features in order not to compromise the protection ensured by the device.

## Dimensions (in mm)

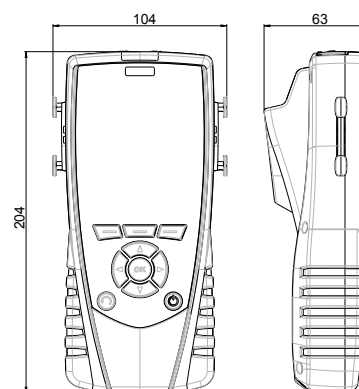

## Housing features

Material	ABS/PC and elastomer
Protection	IP54
Display	LCD 120 x 160 px Dimensions: 58 x 76 mm Backlight Display of 6 measurements including 3 simultaneously
Keypad	Elastomer 10 keys

## Accessories

Name	Reference
PC software for data recording and processing	Datalogger
Mini-DIN / mini-DIN cable for probe	CSM
Backpack	SAD
Infrared printer	KIMP23
Telescopic extension of 1m length bent at 90° for measuring probe	RTE
Wheeled telescopic tripod for radiofrequency probes, 1.20 to 3.50 m length, adjustable at 90°	RTR-3500



Only the accessories supplied with the device must be used.

## Specifications of probes

Probe	Units	Measuring range	Accuracy*	Resolution
Hotwire probe SFC 300 / SFC 900	Air velocity: m/s, fpm, km/h, mph	From 0.15 to 1 m/s	±2% of reading ±0.03 m/s (Specific adjustment and calibration in option)	0.01 m/s
		From 0.15 to 3 m/s From 3.1 to 30 m/s	±3% of reading ±0.03 m/s ±3% of reading ±0.1 m/s	0.01 m/s 0.1 m/s
	Airflow** : m <sup>3</sup> /h, cfm, l/s, m <sup>3</sup> /s	From 0 to 99 999 m <sup>3</sup> /h	±3% of reading or ±0.03* area surface (cm <sup>2</sup> )	1 m <sup>3</sup> /h
	Temperature: °C, °F	From -20 to +80 °C	±0.3% of reading ±0.25 °C	0.1 °C
Ø14 vane probe SH 14 / SHT 14	Air velocity: m/s, fpm, km/h, mph	From 0 to 3 m/s From 3.1 to 25 m/s	From 0.8 to 3 m/s: ±3% of reading ±0.1m/s From 3.1 to 25 m/s: ±1% of reading ±0.3 m/s	0.1 m/s
	Airflow** : m <sup>3</sup> /h, cfm, l/s, m <sup>3</sup> /s	From 0 to 99 999 m <sup>3</sup> /h	±3% of reading or ±0.03* area surface (cm <sup>2</sup> )	1 m <sup>3</sup> /h
	Temperature: °C, °F	From -20 to +80 °C	±0.4% of reading ±0.3 °C	0.1 °C
Ø70 vane probe SH 70 / SHT 70	Air velocity: m/s, fpm, km/h, mph	From -5 to 3 m/s From 3.1 to 35 m/s	From 0.4 to 3 m/s: ±3% of reading ±0.1m/s From 3.1 to 35 m/s: ±1% of reading ±0.3 m/s	0.1 m/s
	Airflow** : m <sup>3</sup> /h, cfm, l/s, m <sup>3</sup> /s	From 0 to 99 999 m <sup>3</sup> /h	±3% of reading or ±0.03* area surface (cm <sup>2</sup> )	1 m <sup>3</sup> /h
	Temperature: °C, °F	From -20 to +80 °C	±0.4% of reading ±0.3 °C	0.1 °C
Ø100 vane probe SH 100 / SHT 100	Air velocity: m/s, fpm, km/h, mph	From -5 to 3 m/s From 3.1 to 35 m/s	From 0.3 to 3 m/s: ±3% of reading ±0.1m/s From 3.1 to 35 m/s: ±1% of reading ±0.3 m/s	0.01 m/s 0.1 m/s
	Airflow** : m <sup>3</sup> /h, cfm, l/s, m <sup>3</sup> /s	From 0 to 99 999 m <sup>3</sup> /h	±3% of reading or ±0.03* area surface (cm <sup>2</sup> )	1 m <sup>3</sup> /h
	Temperature: °C, °F	From -20 to +80 °C	±0.4% of reading ±0.3 °C	0.1 °C
Multifonctiun probe SMT 900	Air velocity: m/s, fpm, km/h, mph	From 0.15 to 3 m/s From 3.1 to 30 m/s	±3% of reading ±0.03 m/s ±3% of reading ±0.1 m/s	0.01 m/s 0.1 m/s
	Airflow** : m <sup>3</sup> /h, cfm, l/s, m <sup>3</sup> /s	From 0 to 99 999 m <sup>3</sup> /h	±3% of reading or ±0.03* area surface (cm <sup>2</sup> )	1 m <sup>3</sup> /h
	Relative humidity: %RH	From 5 to 95% RH	Accuracy (Repeatability, linearity, Hysteresis): ±1.8%RH (from 15°C to 25°C) Factory calibration uncertainty: ±0.88%RH Temperature dependence: ±0.04 x (T-20) %RH (if T<15°C or T>25°C)	0.1% RH
	Temperature: °C, °F	From -20 to +80 °C	±0.3% of reading ±0.25 °C	0.1 °C

VT210 instruments have the following functions for the measurement of temperature, hygrometry and air velocity :

### Climatic Conditions Module

- Selection of units
- Hold, min. & max. values

### Hygrometry/Temperature probe

- Audible alarm (two higher thresholds)
- Selection of units
- Hold, min. and max. values
- Stockage
- Impression

### Thermo-Anemometer

- Calculation of airflow in ducts and with cones
- Selection of the section of the duct
- Automatic average
- Point/point average
- Automatic point/point average
- Integrated Pt100 temperature
- Hold, min. and max. values, standard deviation
- K2 factor

\* All accuracies indicated in this document were stated in laboratory conditions and can be guaranteed for measurements carried out in the same conditions, or carried out with calibration compensation.

\*\* Calculated parameter.

## Delivery kits and options

✓ supplied with

Description	VT 210	VT 210 H	VT 210TH	VT 210 L	VT 210 TL	VT 210 P	VT 210TP	VT 210 F	VT 210 TF	VT 210 M
Hotwire probe (SFC 300)	Optional	Optional	Optional	Optional	Optional	Optional	Optional	✓	Optional	Optional
Telescopic hotwire probe (SFC 900)	Optional	Optional	Optional	Optional	Optional	Optional	Optional	Optional	✓	Optional
Air velocity measurement probe for laboratory hood (SFC 300 S)	Optional	Optional	Optional	Optional	Optional	Optional	Optional	Optional	Optional	Optional
Ø14 mm vane probe (SH 14)	Optional	Optional	Optional	Optional	Optional	✓	Optional	Optional	Optional	Optional
Ø14 mm telescopic vane probe (SHT 14)	Optional	Optional	Optional	Optional	Optional	Optional	✓	Optional	Optional	Optional
Ø70 mm vane probe (SH 70)	Optional	✓	Optional	Optional	Optional	Optional	Optional	Optional	Optional	Optional
Ø70 mm telescopic vane probe (SHT 70)	Optional	Optional	✓	Optional	Optional	Optional	Optional	Optional	Optional	Optional
Ø70 mm wireless vane probe (SHF 70)	Optional	Optional	Optional	Optional	Optional	Optional	Optional	Optional	Optional	Optional
Ø100 mm vane probe (SH 100)	Optional	Optional	Optional	✓	Optional	Optional	Optional	Optional	Optional	Optional
Ø100 mm telescopic vane probe (SHT 100)	Optional	Optional	Optional	Optional	✓	Optional	Optional	Optional	Optional	Optional
Ø100 mm wireless vane probe (SHF 100)	Optional	Optional	Optional	Optional	Optional	Optional	Optional	Optional	Optional	Optional
Multifunction probe (SMT 900)	Optional	Optional	Optional	Optional	Optional	Optional	Optional	Optional	Optional	✓
ABS hygrometry probe (SHR 110)	Optional	Optional	Optional	Optional	Optional	Optional	Optional	Optional	Optional	Optional
Wireless ABS hygrometry probe (SHRF 110)	Optional	Optional	Optional	Optional	Optional	Optional	Optional	Optional	Optional	Optional
Stainless steel hygrometry probe (SHR 300)	Optional	Optional	Optional	Optional	Optional	Optional	Optional	Optional	Optional	Optional
Wireless stainless steel hygrometry probe (SHRF 300)	Optional	Optional	Optional	Optional	Optional	Optional	Optional	Optional	Optional	Optional
Tachometry probe (STA)	Optional	Optional	Optional	Optional	Optional	Optional	Optional	Optional	Optional	Optional
Thermocouple K, J, N, T and S probe	Optional	Optional	Optional	Optional	Optional	Optional	Optional	Optional	Optional	Optional
Pt100 SMART-2014 probe	Optional	Optional	Optional	Optional	Optional	Optional	Optional	Optional	Optional	Optional
Wireless Pt100 probe	Optional	Optional	Optional	Optional	Optional	Optional	Optional	Optional	Optional	Optional
4 thermocouple channels module (M4TC)	Optional	Optional	Optional	Optional	Optional	Optional	Optional	Optional	Optional	Optional
Climatic conditions module (MCC)	Optional	Optional	Optional	Optional	Optional	Optional	Optional	Optional	Optional	Optional
Calibration certificate	Optional	✓	✓	✓	✓	✓	✓	✓	✓	✓
Transport case	✓	✓	✓	✓	✓	✓	✓	✓	✓	✓
Additional battery	Optional	Optional	Optional	Optional	Optional	Optional	Optional	Optional	Optional	Optional

## Available probes and modules (optional)



**4 thermocouple channels module (M4TC)**  
Measuring range from -200 to +1760°C (according to thermocouple)



**Climatic conditions module (MCC)**  
Measuring ranges from 0 to +50°C, from 800 to 1100 hPa and from 5 to 95%RH



**Ø100 mm vane probe\*\***  
Measuring ranges from -5 à 35 m/s, from 0 to 99 999 m³/h and from -20 to +80°C



**Wireless Ø70 mm vane probe\*\***  
Measuring ranges from -5 to 35 m/s, from 0 to 99 999 m³/h and from -20 to +80°C



**Hygrometry probe\***  
Measuring ranges from 3 to 98%RH, from -50 to +100°C<sub>d</sub> and -20 to +80°C



**Wireless hygrometry probe\***  
Measuring ranges from 3 to 98%RH, from -50 to +100°C<sub>d</sub> and from -40 to +180°C



**Optical tachometry probe (STA)**  
Measuring range from 0 to 60 000 tr/min

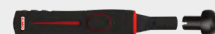

**Contact tachometry probe (STA)**  
Measuring range from 0 to 20 000 tr/min



**Airflow cones**  
Measuring range from 10 to 1200 m³/h depending on model



Large choice of temperature probes (see related datasheet):  
ambient / contact / penetration / immersion...

\*Also available in wireless model / \*\*Also available in telescopic model and in wireless model

