

R2340

REED INSTRUMENTS

Professional Infrared Thermometer



**Instruction
Manual**

www.REEDInstruments.com

Table of Contents

Introduction	4
Product Quality.....	4
Safety	4
Features.....	5
Included.....	5
Specifications.....	6-7
Instrument Description	8
Display Description	9
Distance & Spot Size.....	10
Operating Instructions.....	11-12
<i>Power ON/OFF</i>	11
<i>External Contact Probe Measuring Procedure</i>	11
<i>Non-Contact (Infrared) Temperature Measurement</i>	11
<i>Continuous Temperature Measurement (Trigger Lock)</i>	12
<i>Turning Laser ON/OFF</i>	12
Measurement Modes	13-14
<i>General Mode</i>	13
<i>Infrared Reference Mode</i>	13
<i>Thermal Conduction</i>	14
<i>Dew Point Mode</i>	14
<i>Thermocouple Mode</i>	14
Setup Menu.....	15-22
<i>Set the Time and Date</i>	15-16
<i>Select the Temperature Unit of Measure</i>	16
<i>Set the High and Low Temperature Alarms</i>	16-17
<i>Adjust Emissivity</i>	17

continued...

<i>User scheduled Measurement Recording Interface (Set Rec.)</i>	17
<i>View Interval Recordings (Inquiry)</i>	18
<i>Format</i>	18
<i>Set Recording Intervals</i>	18-20
<i>View/Format Recorded Logs</i>	20
<i>View Interval Recordings</i>	20
<i>Format</i>	20
<i>System Settings</i>	21
<i>Enabling/Disabling Audible Alarm</i>	21
<i>Adjusting LCD Brightness Level</i>	21
<i>Set Trigger Lock Time</i>	22
<i>Set Auto Power OFF</i>	22
<i>Factory Reset</i>	22
<i>System Info</i>	22
Data Logging	23
<i>Saving Measurement Logs</i>	23
<i>Transfer Files to a PC</i>	23
Charging the Battery	24
Applications	24
Accessories	24
Appendix: Emissivity Chart	25-26
Troubleshooting	27
Product Care	28
Product Warranty	28
Product Disposal and Recycling	28
Product Support	29

Introduction

Thank you for purchasing your REED R2340 Professional Infrared Thermometer. Please read the following instructions carefully before using your instrument. By following the steps outlined in this manual your meter will provide years of reliable service.

Product Quality

This product has been manufactured in an ISO9001 facility and has been calibrated during the manufacturing process to meet stated product specifications. If a certificate of calibration is required, please contact the nearest authorized REED distributor or authorized Service Center. Please note an additional fee for this service will apply.

Safety

- Never attempt to repair or modify the instrument. Dismantling the product, other than for the purpose of replacing batteries, may cause damage that will not be covered under the manufacturer's warranty. Servicing should only be provided by an authorized service center.
- Use extreme caution when the laser beam is turned on.
- Do not let the beam enter someone's eye, another person's eye or the eye of an animal.
- Be careful not to point the beam off a reflective surface and strike someone's eye.
- Do not allow the laser light beam to impinge on any gas which can explode.



Features

- Infrared thermometer with integral type K thermocouple input for contact measurement
- Built-in laser pointer identifies target area
- User-selectable °F or °C
- 55:1 Distance to Spot size ratio
- Rechargeable li-ion battery
- High resolution TFT color LCD
- Digitally adjustable emissivity
- Max, Min, Average and Differential readings
- Ambient air temperature, humidity, dew point and wet bulb temperature measurement
- Surface heat conduction, dew point and temperature comparison detection modes
- Audible adjustable alarm
- Internal memory stores up to 999 datapoints
- Trigger lock for continuous monitoring
- Low battery indication and auto shut off

Included

- Professional Infrared Thermometer
- USB Cable
- Type K Bead Thermocouple
- Hard Carrying Case

Specifications

IR Temperature

Measuring Range:	-58.0°F to 3362°F (-50°C to 1850°C)
Accuracy:	-58.0°F to 32°F (-50°C to 0°C): $\pm 2.0^\circ\text{F} + 0.1^\circ\text{F}/^\circ\text{F}$ ($\pm 1.0^\circ\text{C} + 0.1^\circ\text{C}/^\circ\text{C}$) 32°F to 3362°F (0°C to 1850°C): $\pm 2.0^\circ\text{F}$ or $\pm 0.01 \times t^\circ\text{F}$ (Whichever is greater) $(\pm 1.0^\circ\text{C}$ or $\pm 0.01 \times t^\circ\text{C}$ (Whichever is greater))
Resolution:	0.1°F (0.1°C)

Contact Temperature (Type K)

Measuring Range:	-58.0°F to 2498°F (-50°C to 1370°C)
Accuracy:	-58.0°F to 2498°F (-50°C to 1370°C): $\pm 0.005 \times t + 3.0^\circ\text{F}$ ($\pm 0.005 \times t + 1.5^\circ\text{C}$)

Ambient Temperature Measurement

Measuring Range:	14°F to 122°F (-10°C to 50°C)
Accuracy:	14°F to 32°F (-10°C to 0°C): $\pm 2.0^\circ\text{F}$ ($\pm 1.0^\circ\text{C}$) 32°F to 104°F (0°C to 40°C): $\pm 1.0^\circ\text{F}$ ($\pm 0.5^\circ\text{C}$) 104°F to 122°F (40°C to 50°C): $\pm 2.0^\circ\text{F}$ ($\pm 1.0^\circ\text{C}$)
Resolution:	0.1°F (0.1°C)

Relative Humidity

Measuring Range:	10% RH to 90% RH
Accuracy:	$\pm 5\%$ RH

General Specifications

Optical Resolution (D:S):	55:1
Spectral Response:	8 to 14 μm
Emissivity:	0.1 to 1.0 (Adjustable)
Response Time:	250ms

continued...

Display Type:	2.4" TFT LCD
Display Resolution :	320 x 240 pixels
Display Hold:	Yes
High/Low Alarms:	Yes
Max/Min:	Yes
Average and Differential:	Yes
Data Storage:	Yes (Up to 999 groups)
F/C Switchable:	Yes
Trigger Lock:	Yes
Auto Shut-off:	Yes (adjustable from 1 to 30 mins)
Laser Type:	Class II
Low Battery Indicator:	Yes
PC Connectivity:	Yes
Power Supply:	3.7V 2600mAh rechargeable Li-ion battery
Battery Life:	Approx. 20 hours (Fully Charged)
Charging System:	USB-C
Charge Time:	3 hours
Product Certifications:	CE, RoHS, UKCA
Operating Temperature:	14 to 122°F (-10 to 50°C)
Storage Temperature:	-4 to 140°F (-20 to 60°C)
Operating Humidity Range:	10 to 90%
Maximum Operating Altitude:	6561' (2000m)
Maximum Storage Altitude:	39.370' (12.000m)
Dimensions:	8.07 x 4.88 x 2.56" (205 x 124 x 65mm)
Weight:	0.82lbs (375g)

Instrument Description

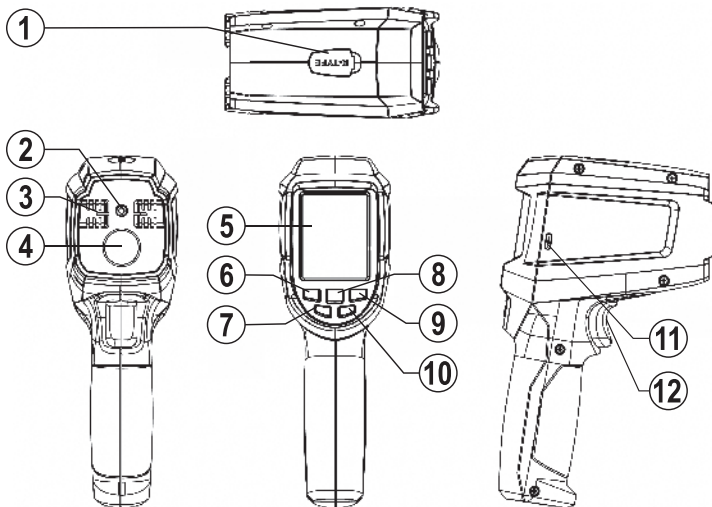

- | | |
|------------------------------------|---------------------|
| 1. Thermocouple Input Jack | 7. Power Button |
| 2. Laser Pointer Beam | 8. OK Button |
| 3. Temperature and Humidity Sensor | 9. Right Button |
| 4. IR Sensor | 10. Back Button |
| 5. LCD Display | 11. USB-C Interface |
| 6. Left Button | 12. Trigger |

Display Description

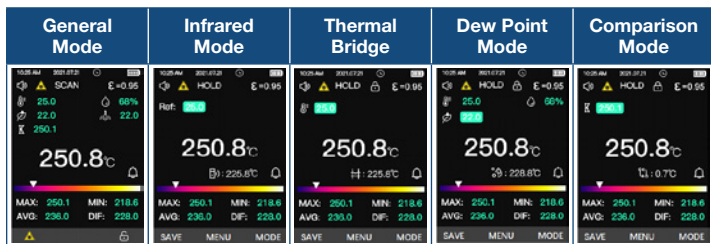

Item	Description	Item	Description
10:25 AM 2021.07.21	Date and time	25.0	Ambient temperature
	Audio alarm	68%	Relative humidity
	Laser	22.0	Dew point temperature
SCAN	Temperature measurement	22.0	Wet bulb temperature
	Appointment	250.1	Type K thermocouple temperature
	Battery status	250.8°C	Infrared temperature
	Lock measurement	MAX: 250.1	Maximum
	Alarm	MIN: 218.6	Minimum
	Range bar	AVG: 236.0	Average
Ref: 25.0	Reference temperature (IR-Ref)	DIF: 228.0	Difference
: 250.8°C	Difference (IR-Ref)	: 225.8°C	Difference (IR-AT)
: 228.8°C	Difference (IR-DP)	: 0.7°C	Difference (comparison mode)

Distance & Spot Size

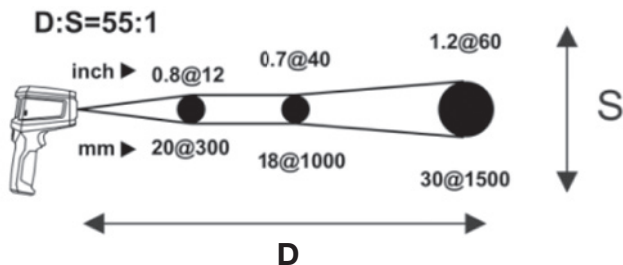

The light spot diameter represents 90% of the energy of the circle.

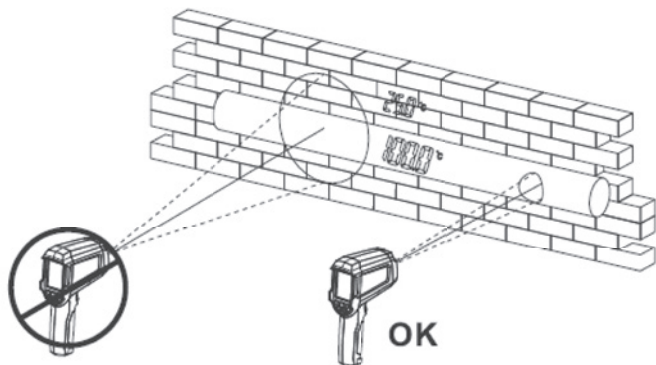

Operating Instructions

Power ON/OFF

To turn the meter ON or OFF press and hold the POWER button for approx. 3 seconds.

External Contact Probe Measuring Procedure

This meter accepts K-type thermocouples with a mini plug. The probe can be used simultaneously while the thermometer is taking non-contact measurements.

The probe readings are shown below the non-contact measurements.

1. Turn the meter on and connect the provided thermocouple.
2. Pull the trigger to begin taking contact probe measurements.
3. The LCD will display the measured contact temperature value.

Note: To take a measurement, make direct contact with the surface being tested. If a thermocouple probe is not connected to the meter, the LCD will display "---.°F or °C".

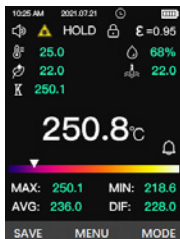

Non-Contact (Infrared) Temperature Measurement

1. Pull and hold the trigger after aiming at the target. The SCAN icon will flash, indicating that the target temperature is being measured.
2. When the trigger is released, the HOLD icon will appear indicating that measurement has stopped and the last measured value will remain on-screen until the next measurement has been taken or the instrument turns off.

Note: Each time the trigger is pulled an internal log is created which captures the following information:





- a) IR temperature
- b) Thermocouple temperature (if connected)
- c) Emissivity
- d) Min/Max/Avg/Dif (if either Min/Max or Avg/Dif is enabled)
- e) Date/Time

continued...

Continuous Temperature Measurement (Trigger Lock)

The instrument allows for continuous temperature measurement to be set from 1 minute to 24 hours. Refer to "Trigger Lock Setup" for details.

Note: This function is applicable for processes that require regular monitoring of temperature.

1. Once the trigger lock function is enabled, pull and hold the trigger after aiming at the target. The SCAN icon will flash, indicating that the target temperature is being measured.
2. Press the  button when the  icon appears in the lower right of the screen to turn the continuous temperature measurement function ON.
3. Release the trigger and the  icon will now appear on the display and the SCAN icon will flash.
4. When the set continuous time for temperature measurement has been reached, both the  and SCAN icons will disappear and the HOLD icon will appear. The thermometer will now hold the last measured value until the next measurement value has been taken or the instrument turns off.

Note: The continuous temperature measurement function can also be turned OFF by pulling the trigger again before time is reached.

Turning Laser ON/OFF

When the trigger is pulled, press the  button to turn the laser indicator function ON and OFF. When turned on, the laser indicator will be displayed on the LCD, while the red laser beam will indicate the position being measured.



Measurement Modes

1. While the meter is powered ON and in HOLD status, press the **▶** button to enter the measurement MODE selection screen.
2. Press the **◀** or **▶** buttons to scroll through each mode as shown in Figure 1.
3. Once the desired mode has been highlighted, press the **OK** button to confirm selection.

Note: At any time, press the **BACK** button or pull the trigger to exit the measurement MODE selection screen and resume normal operation.

General Mode

This mode is suitable for most users and can measure ambient temperature, relative humidity, dew point temperature, wet bulb temperature, type K thermocouple (contact) temperature and infrared (non-contact) temperature. (Figure 2)

Infrared Reference Mode

In this mode, a measured reading can be compared to a reference temperature. If the reference temperature needs to be changed, press the **BACK** button to clear it and measure again. When ready, measure the temperature of the detected object. The thermometer automatically calculates the difference (IR-Ref) by subtracting the temperature of the object being measured (IR) from the reference temperature as shown in Figure 3.

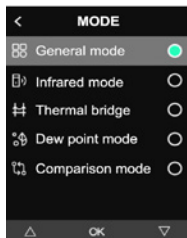

Figure 1

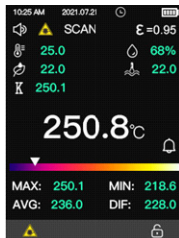

Figure 2

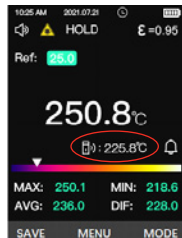

Figure 3

continued...

Thermal Conduction

In this mode, the thermometer automatically calculates the difference between the temperature of the object being measured and the current ambient temperature as shown in Figure 4.

Dew Point Mode

In this mode, the thermometer automatically calculates the difference by subtracting the temperature of the object being measured from the current dew point temperature as shown in Figure 5.

Thermocouple Mode

In this mode, the thermometer automatically calculates the difference by subtracting the temperature of the object being measured from the type K thermocouple temperature as shown in Figure 6.

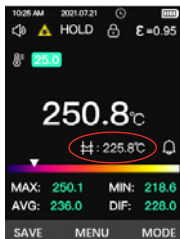

Figure 4

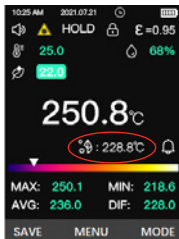

Figure 5

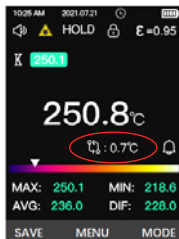

Figure 6

Setup Menu

1. While in the instrument is ON, press the **OK** button to enter the Menu screen.
2. Press the ◀ or ▶ buttons to scroll through the following parameters.

Parameter	Description
Time and Date	Set the time and date
Temperature Unit	Select the temperature unit of measure
HI/Lo Alarms	Set the high and low temperature alarms
Emissivity	Adjust emissivity
Set Rec.	User scheduled Measurement Recording Interface
Storage	View/Format Recorded Logs
System Settings	System Settings Interface

3. Once the appropriate parameter has been selected, follow the instructions below.

Note: At any time, press the **BACK** button or pull the trigger to exit the Setup Menu screen and resume normal operation.

Set the Time and Date

1. Press the **OK** button when "Time and Date" is highlighted to enter the appropriate function.
2. Press the **OK** button again to activate the time format selection (if applicable).
3. Press the ◀ and ▶ buttons to select between 12H and 24H.
4. Press the **OK** button to confirm selection.
5. Press the ◀ and ▶ buttons to highlight the next parameter.
6. Press the **OK** button to activate the Hour digits.
7. Press the ◀ and ▶ buttons to adjust the Hour as indicated by "00:".
8. Press the **OK** button to confirm selection.
9. Repeat steps 6, 7 and 8 to adjust the minutes time stamp as indicated by ":00".

continued...

10. Press the ◀ and ▶ buttons to highlight the next parameter.
11. Press the **OK** button to activate the year digits as indicated by "YYYY".
12. Press the ◀ and ▶ buttons to adjust the Year.
13. Press the **OK** button to confirm selection and activate the month digits as indicated by "MM".
14. Press the ◀ and ▶ buttons to adjust the Month.
15. Press the **OK** button to confirm selection and activate the day digits as indicated by "DD".
16. Press the ◀ and ▶ buttons to adjust the Day.
17. Press the **OK** button to confirm selection.
18. Press the **BACK** button to return to the Setup Menu Screen.

Note: At any time, press the **BACK** button or pull the trigger to exit the Setup Menu screen and resume normal operation.

Select the Temperature Unit of Measure

1. Press the **OK** button when "Temperature unit" is highlighted to enter the appropriate function.
2. Press the ◀ and ▶ buttons to select between °F and °C.
3. Press the **OK** button to confirm selection.
4. Press the **BACK** button to return to the Setup Menu Screen.

Note: At any time, press the **BACK** button or pull the trigger to exit the Setup Menu screen and resume normal operation.

Set the High and Low Temperature Alarms

1. Press the **OK** button when "HI/LO Alarms" is highlighted to enter the appropriate function.
2. Press the ◀ and ▶ buttons to select the desired temperature alarm.
3. Press the **OK** button to activate the applicable temperature alarm.
4. Press the ◀ button to select "-" or "+".
5. Press the ▶ button to confirm selection and jump to the first digit.
6. Press the ◀ button to set the temperature value.

continued...

7. Press the ► button to confirm selection and jump to the next digit.
8. Repeat steps 6 and 7 to adjust the other temperature values (if applicable).
9. When done, press the **OK** button to confirm selection.
10. Press the **BACK** button to return to the Setup Menu Screen.

Note: At any time, press the **BACK** button or pull the trigger to exit the Setup Menu screen and resume normal operation.

Adjust Emissivity

1. Press the **OK** button when "Emissivity" is highlighted to enter the appropriate function.
2. Press the ◀ or ▶ buttons to select between adjusting the emissivity manually and selecting from the preset emissivity table.
3. Press the **OK** button to activate the applicable selection.
4. If manual emissivity adjustment is selected, press the ◀ or ▶ buttons adjust the emissivity value.
5. Press the **OK** button to confirm selection.
6. If the pre-set emissivity table is selected, press the ◀ or ▶ buttons to select the desired emissivity value.
7. When done, press the **OK** button to confirm selection.
8. Press the **BACK** button to return to the Setup Menu Screen.

Note: At any time, press the **BACK** button or pull the trigger to exit the Setup Menu screen and resume normal operation.

User scheduled Measurement Recording Interface (Set Rec.)

1. Press the **OK** button when "Set Rec." is highlighted to enter the appropriate function.
2. Press the ◀ and ▶ buttons to scroll through the following parameters within the User scheduled Measurement Recording Interface.
 - a) View Interval Recordings
 - b) Format
 - c) Set Recording Intervals

Follow the instructions below to adjust each setting.

continued...

View Interval Recordings (Inquiry)

1. Press the **OK** button when "Inquiry" appears on the LCD.
2. Press the ◀ and ▶ buttons to scroll through the list of recorded log files (if applicable).
3. While in a recorded log file, press the **OK** button to delete the desired file.
4. Press the **BACK** button to return to the "User scheduled Measurement Recording Interface" screen.

Note: At any time, press the **BACK** button twice or pull the trigger to exit the Setup Menu screen and resume normal operation.

Format

1. Press the **OK** button when "Format" is highlighted to enter the appropriate function.
2. Press the ◀ or ▶ buttons to select between "Yes" and "No".
3. If "Yes" is selected, the meter will format/erase all recorded files.
4. When complete, the meter will automatically return to the "User scheduled Measurement Recording Interface" screen.

Note: At any time, press the **BACK** button twice or pull the trigger to exit the Setup Menu screen and resume normal operation.

Set Recording Intervals

1. Press the **OK** button when "Set Recording Intervals" is highlighted to enter the appropriate function.
2. Press the **OK** button again to "OPEN"/Enable the "set recording intervals" menu screen.
3. Press the **OK** button a third time to activate the "Start Date" selection.
4. Press the ◀ and ▶ buttons to set the Year (YYYY).
5. Press the **OK** button to confirm selection and activate the month digits as indicated by "MM".
6. Press the ◀ and ▶ buttons to adjust the Month.
7. Press the **OK** button to confirm selection and activate the day digits as indicated by "DD".
8. Press the ◀ and ▶ buttons to adjust the Day.

continued...

9. Press the **OK** button to confirm selection.
10. Press the ◀ and ▶ buttons to highlight the next parameter.
11. Press the **OK** button to activate the "Start Time" Hour digits.
12. Press the ◀ and ▶ buttons to adjust the Hour as indicated by "00:".
13. Press the **OK** button to confirm selection activate the "Start Time" minute digits.
14. Press the ◀ and ▶ buttons to adjust the minutes as indicated by "00:".
15. Press the **OK** button to confirm selection.
16. Press the ◀ and ▶ buttons to highlight the next parameter.
17. Press the **OK** button to activate the recording intervals Hour digits.

Note: Recording intervals can be set anywhere between 1 minute and 24 Hours.

18. Press the ◀ and ▶ buttons to adjust the Hour as indicated by "00:".
19. Press the **OK** button to confirm selection and activate the minutes digits as indicated by "mm".
20. Press the ◀ and ▶ buttons to adjust the minutes as indicated by ":00".
21. Press the **OK** button to confirm selection.
22. Press the ◀ and ▶ buttons to highlight the next parameter.
23. Press the **OK** button to activate the first digit of the "Frequency" selection.

Note: Up to 999 recordings/logs can be set at one time.

24. Press the ◀ and ▶ buttons to adjust the first digit if applicable.
25. Press the **OK** button to confirm selection and jump to the next digit.
26. Press the ◀ and ▶ buttons to adjust the second digit if applicable.
27. Press the **OK** button to confirm selection and jump to the next digit.
28. Press the ◀ and ▶ buttons to adjust the third digit if applicable.
29. Press the **OK** button to confirm selection.
30. To disable this feature, the "Close" selection box must be selected by pressing the **OK** button when highlighted.

continued...

31. Press the **BACK** button to return to the Setup Menu Screen.

Note: At any time, press the **BACK** button twice or pull the trigger to exit the Setup Menu screen and resume normal operation.

View/Format Recorded Logs

1. Press the **OK** button when "Storage" is highlighted to enter the appropriate function.
2. Press the ◀ and ▶ buttons to scroll through the following parameters within the Storage interface.
 - a) View Interval Recordings
 - b) Format

Follow the instructions below to adjust each setting.

View Interval Recordings

1. Press the **OK** button when "Inquiry" appears on the LCD.
2. Press the ◀ and ▶ buttons to scroll through the list of interval recorded log files (if applicable).
3. While in a recorded log file, press the **OK** button to delete the desired file.
4. Press the **BACK** button to return to the "Memory Storage Interface" screen.

Note: At any time, press the **BACK** button twice or pull the trigger to exit the Setup Menu screen and resume normal operation.

Format

1. Press the **OK** button when "Format" is highlighted to enter the appropriate function.
2. Press the ◀ or ▶ buttons to select between "Yes" and "No".
3. If "Yes" is selected, the meter will format/erase all interval recorded log files.
4. When complete, the meter will automatically return to the "Memory Storage Interface" screen.

Note: At any time, press the **BACK** button twice or pull the trigger to exit the Setup Menu screen and resume normal operation.

continued...

System Settings

1. Press the **OK** button when "System Settings" is highlighted to enter the appropriate function.
2. Press the ◀ and ▶ buttons to scroll through the following parameters within the "System Settings" interface.
 - a) Audible Alarm
 - b) Brightness
 - c) Lock time
 - d) Auto Power Off
 - e) Factory Reset
 - f) System Info

Enabling/Disabling Audible Alarm

1. Press the **OK** button when "Audible Alarm" is highlighted to enter the appropriate function.
2. Press the ◀ or ▶ buttons to select between "ON" and "OFF".
3. Press the **BACK** button to return to the "System Settings" screen.

Note: At any time, press the **BACK** button twice or pull the trigger to exit the Setup Menu screen and resume normal operation.

Adjusting LCD Brightness Level

1. Press the **OK** button when "Brightness" is highlighted to enter the appropriate function.
2. Press the ◀ or ▶ buttons to select between "High", "Medium" and "Low" brightness levels.
3. Press the **OK** button to confirm selection.
4. Press the **BACK** button to return to the "System Settings" screen.

Note: At any time, press the **BACK** button twice or pull the trigger to exit the Setup Menu screen and resume normal operation.

continued...

Set Trigger Lock Time

1. Press the **OK** button to activate the "Lock time" Hour digits.
2. Press the ◀ and ▶ buttons to adjust the Hour as indicated by "00:" if applicable.
3. Press the **OK** button to confirm selection and activate the "Lock time" minute digits.
4. Press the ◀ and ▶ buttons to adjust the minutes as indicated by "00:".
5. Press the **OK** button to confirm selection.

Note: At any time, press the **BACK** button twice or pull the trigger to exit the Setup Menu screen and resume normal operation.

Set Auto Power OFF

1. Press the **OK** button to activate the "Auto Power off" minutes digits.
2. Press the ◀ and ▶ buttons to adjust the minutes as indicated by "00".
3. Press the **OK** button to confirm selection.

Note: At any time, press the **BACK** button twice or pull the trigger to exit the Setup Menu screen and resume normal operation.

Factory Reset

1. Press the **OK** button when "Factory Reset" is highlighted to enter the appropriate function.
2. Press the ◀ or ▶ buttons to select between "Yes" and "No".
3. When complete, the meter will automatically return to the "System Settings" screen.

Note: At any time, press the **BACK** button twice or pull the trigger to exit the Setup Menu screen and resume normal operation.

System Info

1. Press the **OK** button when "System Info" is highlighted to view the device information.
2. Press the **BACK** button to return to the "System Settings" screen.

Note: At any time, press the **BACK** button twice or pull the trigger to exit the Setup Menu screen and resume normal operation.

Data Logging

Saving Measurement Logs

1. Pull the trigger to take a measurement.
2. Release the trigger to stop the measurement and return to HOLD measurement status.
3. Press the ◀ button to save the current measurement log.
4. Press the ◀ or ▶ button to select the sequence number to be saved.
5. Press the **OK** button to confirm selection.

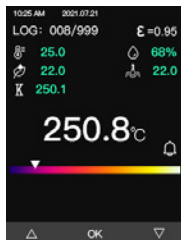

Transfer files to a PC

To transfer recorded information to a PC, connect the included USB cable to the instrument and a computer.

1. Plug the USB cable into the USB-C interface and turn the instrument on.
2. Press the **OK** button to enter the MENU screen.
3. Press the ◀ or ▶ buttons to select "Generate table".
4. Press the **OK** button to confirm selection.
5. After the table is generated, the computer will automatically recognize the meter as a removable device and open the drive to view the generated logs in PDF/CSV formats.

Note: No software is necessary to view saved data. Simply click and drag data from the device on to a computer's desktop or open directly from any of the folders.

Charging the Battery

1. Connect the R2340 via the included cable to a USB port on a PC or into a wall outlet using a USB Power Adapter (not included).
2. Charge the meter until the battery indicator appears full and remove the charging cable when complete.

Applications

- Verify mechanical (bearings, motors) or electrical (circuit breaker boxes) equipment
- Calibration and control of heater and oven temperatures
- Monitoring materials in processes involving heating and/or cooling
- Quality control monitoring
- Research and development applications
- Automotive diagnostics
- Conduct HVAC/R energy audits

Accessories

R8888 Medium Hard Carrying Case

Don't see your part listed here? For a complete list of all accessories and replacement parts visit your product page on www.REEDInstruments.com.

Appendix: Emissivity Chart

Emissivity is a term used to describe the energy-emitting characteristics of materials. Most (90% of typical applications) organic materials and painted or oxidized surfaces have an emissivity of 0.95. Inaccurate readings will result from measuring shiny or polished metal surfaces. To compensate, cover the surface to be measured with masking tape or flat black paint. Allow time for the tape to reach the same temperature as the material underneath it. Measure the temperature of the tape or painted surface.

Measured Surfaces	Emmissivity
Metal	
Aluminum: Oxidization	0.2-0.4
A3003 Alloy: Oxidization, Rough	0.3, 0.1-0.3
Brass: Burnishing, Oxidization	0.3, 0.5
Copper: Oxidization Electric Terminal Board	0.4-0.8, 0.6
Hastelloy: Alloy	0.3-0.8
Inconel: Oxidization Sand-Blasting, Electro Burnishing	0.7-0.95, 0.3-0.6, 0.15
Iron: Oxidization Rusting	0.5-0.9, 0.5-0.7
Iron (Casting): Oxidization, Non-Oxidization, Casting	0.6-0.95, 0.2, 0.2-0.3
Iron (Forging): Passivation	0.9
Lead: Rough, Oxidization	0.4, 0.2-0.6
Molybdenum: Oxidization	0.2-0.6
Nickel: Oxidization	0.2-0.5
Platimun: Black	0.9
Steel: Cold Rolling, Steel Plate-Burnishing, Steel Plate Rubbing	0.7-0.9, 0.4-0.6, 0.1

continued...

Measured Surfaces	Emmissivity
Zinc: Oxidization	0.1
Non-Metal	
Asbestos	0.95
Asphalt	0.95
Basalt	0.7
Carbon: Non-Oxidization, Graphite, Silicon Carbide	0.8-0.9, 0.7-0.8, 0.9
Ceramics	0.95
Clay	0.95
Concrete	0.95
Cloth	0.9
Glass: Convex, Smooth, Lead-Boron	0.76-0.8, 0.92-0.94, 0.78-0.82
Plates	0.96
Stone Products	0.93
Plaster	0.8-0.95
Ice	0.98
Limestone	0.98
Paper	0.95
Plastics	0.95
Water	0.93
Soil	0.9-0.98
Wood	0.9-0.95

Troubleshooting

Symptom	Problem	Action
"OL" appears on display when measuring	Measured value is greater than the maximum range	Stop measuring
"-OL" appears on display when measuring	Measured value is less than the minimum range	Stop measuring
"Err" appears when booting	Exceeding the minimum or maximum operating ambient temperature	Place the thermometer in a 32 to 122°F (0 to 50°C) environment and resume operation after 30 minutes
Low battery indicator flashes	Low Battery	Charge the meter
Display "Er0" (startup)	Internal product damage	Restart the product or charge and then turn it on. If it is still not functioning properly, it needs to be returned for service
Inaccurate measurement	Wrong emissivity setting, measured distance is too far, measured target diameter is less than 20mm, etc.	Refer to Field of View, D:S and other instructions in this manual

Product Care

To keep your instrument in good working order we recommend the following:

- Store your product in a clean, dry place.
- Change the battery as needed.
- If your instrument isn't being used for a period of one month or longer please remove the battery.
- Clean your product and accessories with biodegradable cleaner. Do not spray the cleaner directly on the instrument. Use on external parts only.

Product Warranty

REED Instruments guarantees this instrument to be free of defects in material or workmanship for a period of one (1) year from date of shipment. During the warranty period, REED Instruments will repair or replace, at no charge, products or parts of a product that proves to be defective because of improper material or workmanship, under normal use and maintenance. REED Instruments total liability is limited to repair or replacement of the product. REED Instruments shall not be liable for damages to goods, property, or persons due to improper use or through attempts to utilize the instrument under conditions which exceed the designed capabilities. In order to begin the warranty service process, please contact us by phone at 1-877-849-2127 or by email at info@reedinstruments.com to discuss the claim and determine the appropriate steps to process the warranty.

Product Disposal and Recycling



Please follow local laws and regulations when disposing or recycling your instrument. Your product contains electronic components and must be disposed of separately from standard waste products.

Product Support

If you have any questions on your product, please contact your authorized REED distributor or REED Instruments Customer Service by phone at 1-877-849-2127 or by email at info@reedinstruments.com.

Please visit www.REEDInstruments.com for the most up-to-date manuals, datasheets, product guides and software.

*Product specifications subject to change without notice.
All rights reserved. Any unauthorized copying or reproduction of this manual is strictly prohibited without prior written permission from REED Instruments.*

Notes:

REED INSTRUMENTS

TEMPERATURE
& HUMIDITY



SOUND



MOISTURE



AIR VELOCITY



ELECTRICAL



www.REEDInstruments.com

REED INSTRUMENTS

TEST & MEASURE WITH CONFIDENCE



Over 200 portable test and
measurement instruments

Access our
Product Catalog



www.REEDInstruments.com