



RB SERIES

Digital Temperature Controller

RB100/RB400
RB500/RB700
RB900

Instruction Manual

- Modbus is a registered trademark of Schneider Electric.
- Company names and product names used in this manual are the trademarks or registered trademarks of the respective companies.

Thank you for purchasing this RKC product. In order to achieve maximum performance and ensure proper operation of the new instrument, carefully read all the instructions in this manual. Please place the manual in a convenient location for easy reference.

NOTICE

- This manual assumes that the reader has a fundamental knowledge of the principles of electricity, process control, computer technology and communications.
- The figures, diagrams and numeric values used in this manual are only for explanation purpose.
- RKC is not responsible for any damage or injury that is caused as a result of using this instrument, instrument failure or indirect damage.
- RKC is not responsible for any damage and/or injury resulting from the use of instruments made by imitating this instrument.
- Periodic maintenance is required for safe and proper operation of this instrument. Some components have a limited service life, or characteristics that change over time.
- Every effort has been made to ensure accuracy of all information contained herein. RKC makes no warranty, expressed or implied, with respect to the accuracy of the information. The information in this manual is subject to change without prior notice.
- No portion of this document may be reprinted, modified, copied, transmitted, digitized, stored, processed or retrieved through any mechanical, electronic, optical or other means without prior written approval from RKC.



WARNING

- To prevent injury to persons, damage to the instrument and the equipment, a suitable external protection device shall be required.
- All wiring must be completed before power is turned on to prevent electric shock, fire or damage to the instrument and the equipment.
- This instrument must be used in accordance with the specifications to prevent fire or damage to the instrument and the equipment.
- This instrument is not intended for use in locations subject to flammable or explosive gases.
- Do not touch high-voltage connections such as power supply terminals, etc. to avoid electric shock.
- RKC is not responsible if this instrument is repaired, modified or disassembled by other than factory-approved personnel. Malfunction may occur and warranty is void under these conditions.

CAUTION

- This product is intended for use with industrial machines, test and measuring equipment. (It is not designed for use with medical equipment and nuclear energy plant.)
- This is a Class A instrument. In a domestic environment, this instrument may cause radio interference, in which case the user may be required to take additional measures.
- This instrument is protected from electric shock by reinforced insulation. Provide reinforced insulation between the wire for the input signal and the wires for instrument power supply, source of power and loads.
- Be sure to provide an appropriate surge control circuit respectively for the following:
 - If input/output or signal lines within the building are longer than 30 meters.
 - If input/output or signal lines leave the building, regardless the length.
- This instrument is designed for installation in an enclosed instrumentation panel. All high-voltage connections such as power supply terminals must be enclosed in the instrumentation panel to avoid electric shock to operating personnel.
- All precautions described in this manual should be taken to avoid damage to the instrument or equipment.
- If the equipment is used in a manner not specified by the manufacturer, the protection provided by the equipment may be impaired.
- All wiring must be in accordance with local codes and regulations.
- All wiring must be completed before power is turned on to prevent electric shock, instrument failure, or incorrect action. The power must be turned off before repairing work for input break and output failure including replacement of sensor, contactor or SSR, and all wiring must be completed before power is turned on again.
- To prevent instrument damage as a result of failure, protect the power line and the input/output lines from high currents with a suitable overcurrent protection device with adequate breaking capacity such as a fuse, circuit breaker, etc.
- A malfunction in this product may occasionally make control operations impossible or prevent alarm outputs, resulting in a possible hazard. Take appropriate measures in the end use to prevent hazards in the event of malfunction.
- Prevent metal fragments or lead wire scraps from falling inside instrument case to avoid electric shock, fire or malfunction.
- Tighten each terminal screw to the specified torque found in the manual to avoid electric shock, fire or malfunction.
- For proper operation of this instrument, provide adequate ventilation for heat dissipation.
- Do not connect wires to unused terminals as this will interfere with proper operation of the instrument.
- Turn off the power supply before cleaning the instrument.
- Do not use a volatile solvent such as paint thinner to clean the instrument. Deformation or discoloration may occur. Use a soft, dry cloth to remove stains from the instrument.
- To avoid damage to the instrument display, do not rub with an abrasive material or push the front panel with a hard object.

FOR PROPER DISPOSAL

- When disposing of each part used for this instrument, always follows the procedure for disposing of industrial wastes stipulated by the respective local community.

SYMBOLS

Safety Symbols:

WARNING : This mark indicates precautions that must be taken if there is danger of electric shock, fire, etc., which could result in loss of life or injury.

CAUTION : This mark indicates that if these precautions and operating procedures are not taken, damage to the instrument may result.



: This mark indicates that all precautions should be taken for safe usage.



: This mark indicates important information on installation, handling and operating procedures.



: This mark indicates supplemental information on installation, handling and operating procedures.



: This mark indicates where additional information may be located.

Character Symbols:

Upper row: 11 segment display characters

Lower row: 7 segment display characters

0	1	2	3	4	5	6	7	8	9	Minus	Period
0	1	2	3	4	5	6	7	8	9	-	.
0	1	2	3	4	5	6	7	8	9	-	.
A	B (b)	C	c	D (d)	E	F	G	H	I	J	K
A	b	C	c	d	E	F	G	H	I	J	K
A	b	C	c	d	E	F	G	H	I	J	K
L	M	N (n)	O (o)	P	Q	q	R	r	S	T	t
L	M	N	o	P	Q	q	R	r	S	T	t
L	n̄	n	o	P	q	q	r	r	S	T	t
U	u	V	W	X	Y	Z	Prime	/			
U	u	V	W	X	Y	Z	'	/			
U	u	V	W	X	Y	Z	'	/			

■ Unit character symbols

°C	°F	%
°C	°F	%

■ Abbreviation symbols

These abbreviations are used in this manual:

Abbreviation symbols	Name
PV	Measured value (PV)
SV	Set value (SV)
AT	Autotuning
ST	Startup tuning
HBA1	Heater break alarm 1
HBA2	Heater break alarm 2
CT1	Current transformer 1
CT2	Current transformer 2
LBA	Control loop break alarm
LBD	LBA deadband
EV	Event set value

DOCUMENT CONFIGURATION

There are six manuals pertaining to this product. Please be sure to read all manuals specific to your application requirements. If you do not have a necessary manual, please contact RKC sales office, the agent, or download from the official RKC website.

The following manuals can be downloaded from the official RKC website:

https://www.rkcinst.com/english/manual_load.htm.

Manual	Manual Number	Remarks
RB series Installation Manual (RB100/400/500/700/900)	IMR02C38-E□	This manual is enclosed with instrument. This manual explains the mounting and wiring, front panel name, and the operation mode outline.
RB series Quick Operation Manual (RB100/400/500/700/900)	IMR02C39-E□	This manual is enclosed with instrument. This manual explains the basic key operation, mode menu, and data setting.
RB series Parameter List (RB100/400/500/700/900)	IMR02C40-E□	This manual is enclosed with instrument. This list is a compilation of the parameter data of each mode.
RB series Communication Quick Instruction Manual (RB100/400/500/700/900)	IMR02C41-E□	This manual is enclosed with instrument. (Only RB100/RB400/RB500/RB700/RB900s provided with the communication function) This manual explains the connection method with host computer, communication parameters, and communication data (except for parameters in Engineering Mode).
RB100/RB400/RB500/ RB700/RB900 Instruction Manual *	IMR02C15-E6	This manual explains the method of the mounting and wiring, operation of various functions, and troubleshooting.
RB100/RB400/RB500/ RB700/RB900 Communication Instruction Manual *	IMR02C16-E□	This manual explains RKC communication protocol (ANSI X3.28-1976) and Modbus relating to communication parameters setting.

* Sold separately



Read this manual carefully before operating the instrument. Please place the manual in a convenient location for easy reference.

CONTENTS

	Page
1. OUTLINE	1-1
1.1 Features	1-2
1.2 Input/Output and Function Blocks.....	1-3
1.3 Checking the Product	1-4
1.4 Model Code	1-5
■ Suffix code.....	1-5
■ Quick start code (Initial setting code)	1-7
1.5 Parts Description	1-8
1.6 Handling Procedure to Operation	1-13
2. MOUNTING	2-1
2.1 Mounting Cautions.....	2-2
2.2 Dimensions.....	2-3
■ RB100	2-3
■ RB400	2-3
■ RB500	2-4
■ RB700	2-4
■ RB900	2-5
2.3 Procedures of Mounting and Removing	2-6
■ The mounting position of mounting bracket.....	2-6
■ Mounting procedures (Not supplied)	2-7
■ Mounting procedures (Waterproof/Dustproof type)	2-8
■ Removal procedures	2-9
3. WIRING	3-1
3.1 Wiring Cautions	3-2
3.2 Terminal Layout.....	3-5
■ RB100	3-5
■ RB400	3-5
■ RB500	3-6
■ RB700	3-6
■ RB900.....	3-7
■ Isolations of input and output	3-7
3.3 Wiring of Each Terminal	3-8
■ Power supply.....	3-8
■ Output 1 (OUT1)/Output 2 (OUT2).....	3-9
■ Transmission output (AO) [optional].....	3-10
■ Digital output 1 to 4 (DO1 to DO4) [optional].....	3-11
■ Measured input (Thermocouple/RTD/Voltage/Current) [universal input].....	3-12

	Page
■ Digital input (DI1, DI2) [optional].....	3-13
■ Current transformer (CT) input [optional].....	3-13
■ Communication [optional].....	3-14
3.4 Handling of the Terminal Cover [optional]	3-15
■ Mounting procedures.....	3-15
■ Removal procedures	3-16
4. BASIC OPERATION	4-1
4.1 Operation Menu	4-2
4.2 Changing Set Value.....	4-4
5. SETUP PROCEDURES PRIOR TO RUNNING THE INSTRUMENT.....	5-1
5.1 Initial Setting	5-3
■ Check the parameter related to the input	5-3
■ Check the parameter related to the event	5-4
■ Check the parameter related to the control action.....	5-5
5.2 Operation Setting.....	5-6
■ Set the control set value	5-6
■ Set the event set value	5-7
5.3 Operation Start	5-8
■ Change from STOP to RUN	5-9
■ Tuning PID parameters	5-10
● Start the Autotuning (AT)	5-10
● To manually adjust the PID parameters.....	5-11
● Changing control response with Fine tuning.....	5-12
6. OPERATIONS OF THE BASIC FUNCTIONS	6-1
6.1 RUN/STOP Transfer.....	6-2
■ RUN/STOP transfer by front key operation	6-3
■ Performing RUN/STOP transfer in the “RUN/STOP setting” (Engineering mode)	6-3
■ RUN/STOP transfer by digital input (DI) [optional]	6-5
6.2 Autotuning (AT)	6-8
■ Caution for using the Autotuning (AT)	6-8
■ Requirements for Autotuning (AT) start.....	6-8
■ Requirements for Autotuning (AT) cancellation.....	6-8
■ Autotuning (AT) start/stop operation.....	6-9

	Page
6.3 Startup Tuning (ST)	6-11
■ Caution for using the Startup tuning (ST)	6-11
■ Requirements for Startup tuning (ST) start.....	6-12
■ Requirements for Startup tuning (ST) cancellation.....	6-12
■ Startup tuning (ST) setting.....	6-13
6.4 Fine Tuning.....	6-17
■ To make control response faster	6-17
■ To make control response slower.....	6-18
6.5 Auto/Manual Transfer	6-20
■ Bumpless function with Auto/Manual transfer	6-20
■ Auto/Manual transfer by front key operation.....	6-21
■ Auto/Manual transfer by digital input (DI)	6-22
■ Procedure for setting the Manipulated output value (MV) in Manual mode.....	6-23
6.6 Protecting Setting Data (Data lock function)	6-24
■ Set lock level	6-24
■ Setting procedure flowchart.....	6-24
■ Set lock level of Parameter setting mode	6-25
■ Locking all data which can be locked	6-26
■ Selecting the parameter to lock.....	6-28
■ Locking F21 to F91 data.....	6-30
6.7 Display/No display Setting of Mode Screens	6-32
■ Hiding the parameters of the Monitor display mode	6-34
■ Hiding the parameters of the Mode switching screen.....	6-35
■ Hiding the parameters of the Parameter setting mode	6-37
■ Displaying Function block 21 (F21) to Function block 91 (F91) of the Engineering mode.....	6-38
6.8 Interlock Release	6-39
■ Interlock release by front key operation.....	6-40
■ Interlock release by digital input (DI)	6-41

7. OPERATING ADDITIONAL FUNCTIONS.....7-1

7.1 SV Selection Function (Step SV function)	7-2
■ Setting procedure	7-2
■ SV selection by front key operation.....	7-3
■ SV selection by digital input (DI).....	7-4
7.2 Timer Function.....	7-5
■ Control start (RUN) by Timer function (Timer function 1)	7-5
■ Control stop (STOP) by Timer function (Timer function 2)	7-7
■ Ramp/Soak control (Timer function 3, Timer function 4)	7-9

	Page
7.3 Transmission Output Function.....	7-12
■ Setting procedure	7-12
■ Output calibration	7-13

8. PARAMETER DESCRIPTION8-1

8.1 Monitor Display Mode.....	8-2
8.1.1 Display sequence.....	8-2
8.1.2 Monitor item	8-3
8.2 SV Setting Mode.....	8-6
8.2.1 Display sequence.....	8-6
8.2.2 Setting item	8-7
8.3 Mode Switching	8-9
8.3.1 Display sequence.....	8-9
8.3.2 Operation item.....	8-10
8.4 Parameter Setting Mode.....	8-12
8.4.1 Display sequence.....	8-12
8.4.2 Parameter setting item	8-13
8.5 Engineering Mode	8-43
8.5.1 Display sequence.....	8-43
■ Function block structure in the Engineering mode	8-51
■ Restricting access to Engineering mode	8-51
8.5.2 Precaution against parameter change	8-52
■ When Input type (INP) is changed.....	8-52
■ When Transmission output type (Ao) is changed.....	8-53
■ When Event 1 type (ES1) is changed.....	8-53
■ When Event 2 type (ES2) is changed.....	8-53
■ When Event 3 type (ES3) is changed.....	8-53
■ When Event 4 type (ES4) is changed.....	8-53
■ When Output limiter high (oLH) is changed.....	8-53
■ When Output limiter low (oLL) is changed.....	8-53
■ When Decimal point position (PGdP) is changed.....	8-54
■ When Input scale high (PGSH) is changed.....	8-54
■ When Input scale low (PGSL) is changed.....	8-55
■ When Setting limiter high (SLH) is changed.....	8-55
■ When Setting limiter low (SLL) is changed.....	8-55
■ When Communication protocol (CMPS) is changed	8-55
■ When Timer time unit (TMU) is changed.....	8-55
■ Example of automatic conversion.....	8-56
8.5.3 Engineering setting item.....	8-57

	Page
9. TROUBLESHOOTING	9-1
9.1 Error Display	9-2
■ Display when input error occurs	9-2
■ Self-diagnostic error	9-3
9.2 Solutions for Problems	9-4
■ Display	9-5
■ Control	9-6
■ Operation	9-8
■ Event function	9-9
■ Heater break alarm (HBA)	9-9
 10. SPECIFICATIONS	 10-1
 APPENDIX	 A-1
A. Removing the Internal Assembly	A-2
B. Replacing the Waterproof/Dustproof Rubber Gasket	A-4
C. Current Transformer (CT) Dimensions	A-6
D. 250 Ω Shunt Resistor for Current Input	A-7
 INDEX	 B-1

OUTLINE



This chapter describes features, package contents and model code, etc.

1.1 Features	1-2
1.2 Input/Output and Function Blocks	1-3
1.3 Checking the Product	1-4
1.4 Model Code	1-5
■ Suffix code	1-5
■ Quick start code (Initial setting code).....	1-7
1.5 Parts Description	1-8
1.6 Handling Procedure to Operation	1-13

1.1 Features

This high performance digital controller has the following features:

- **Panel space saving: 60 mm depth (RB400/500/700/900), 63 mm (RB100)**
- **11-segment LCD display for the PV display**
- **Sampling time 250 ms**
- **Advanced autotuning with ARW function**
- **“Fine tuning” that changes responsiveness**

A new 6 level Fine tuning allows the operator to control response from fast to slow by changing the Fine tuning setting (–3 to +3) while the PID constant remains unchanged.

- **Startup tuning eliminates autotuning time**

Conventional autotuning time is eliminated by startup autotuning which calculates optimum PID values immediately upon startup.

- **Up to four (4) set values, create simple Ramp/Soak function**

A simple ramp/soak function can be created by using the Timer function and Setting change rate limiter, and Digital input (DI). In Engineering mode change from “No Display” to “Display”.

- **Timer function**

The Timer function can be turned on in Engineering mode to start or stop control after the set time has elapsed or to create a simple 4 step ramp/soak program.

- **Easy parameter setup via USB loader port**

Saving parameter settings to a PC and copying parameters to other controllers becomes easy with the USB port, a COM-K2 converter, and our communication tool (PROTEM2 or WinUCI) *.

* Download the software from the official RKC website: <https://www.rkcinst.com/>

- **Easy maintenance**

The internal assembly of the RB Series can be removed from the front.

- **NEMA4X and IP66 waterproof and dustproof protection for severe environments (optional)**

1.2 Input/Output and Function Blocks

This section describes the input/output and function blocks of the instrument.

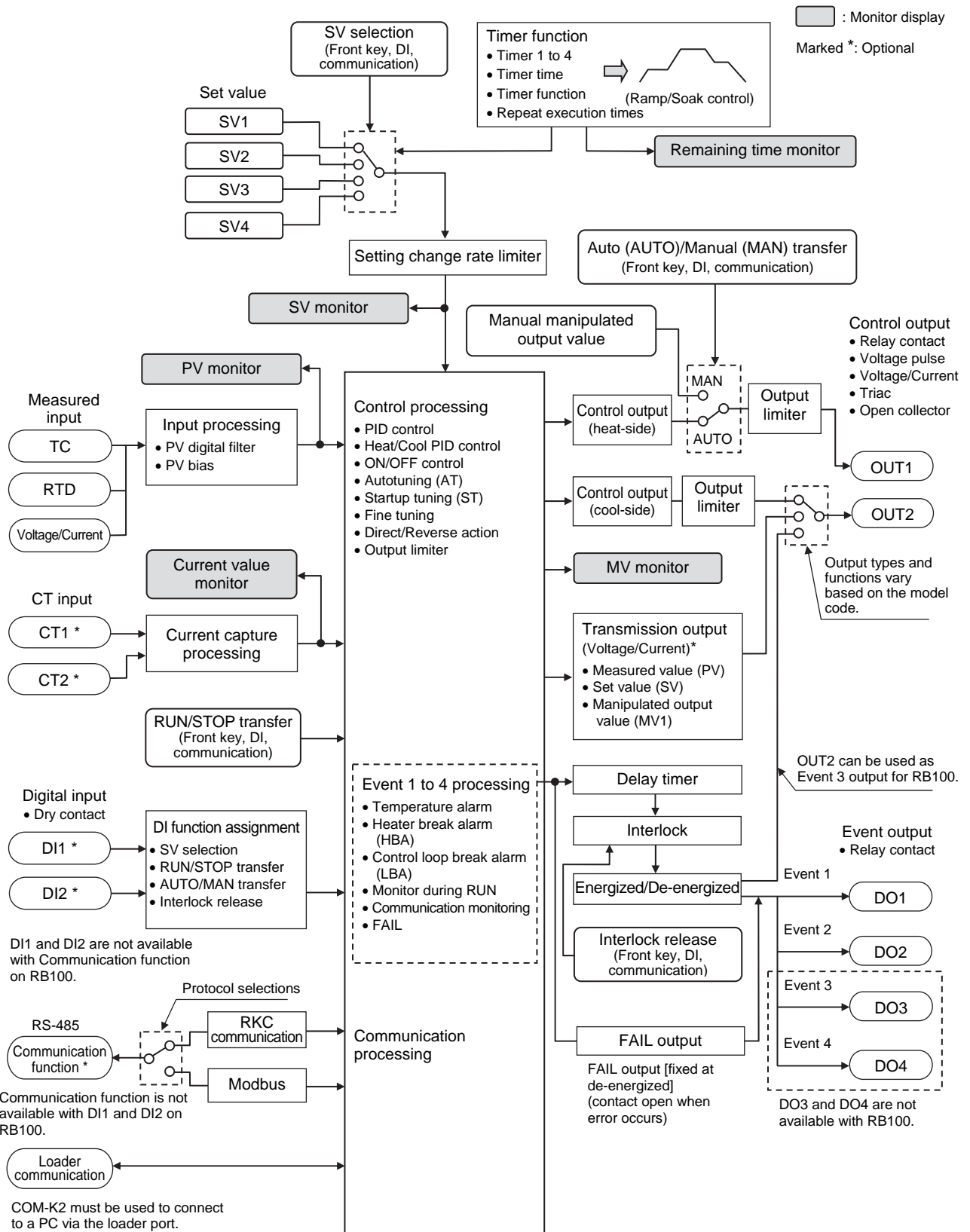

1.3 Checking the Product

Before using this product, check each of the following:

- Model code
- Check that there are no scratches or breakage in external appearance (case, front panel, or terminal, etc.)
- Check that all of the items delivered are complete. (Refer to below)

Accessories	Q'TY	Remarks	
<input type="checkbox"/> Instrument	1	_____	
<input type="checkbox"/> Mounting bracket (with screw)	2	RB900 Waterproof/Dustproof type: 4	
<input type="checkbox"/> Case rubber gasket KRB100-39 (RB100) KFB400-36 (RB400/500) KRB700-310 (RB700) KFB900-36 (RB900)	1	Waterproof/Dustproof type	
<input type="checkbox"/> Installation Manual (IMR02C38-E□)	1	Enclosed with instrument	
<input type="checkbox"/> Quick Operation Manual (IMR02C39-E□)	1	Enclosed with instrument	
<input type="checkbox"/> Parameter List (IMR02C40-E□)	1	Enclosed with instrument	
<input type="checkbox"/> Communication Quick Instruction Manual (IMR02C41-E□)	1	Enclosed with instrument (For RB Series with Communication)	
<input type="checkbox"/> Instruction Manual (IMR02C15-E6)	1	This manual (sold separately)	This manual can be downloaded from the official RKC website: https://www.rkcinst.com/english/manual_load.htm .
<input type="checkbox"/> Communication Instruction Manual (IMR02C16-E□)	1	Sold separately	
<input type="checkbox"/> Terminal cover KCA100-517 (RB100) KFB400-58 (RB400/500) KRB700-53 (RB700) KFB400-58 (RB900)	1	Optional (sold separately) Two (2) terminal covers may be required for RB900 depending on specifications.	
<input type="checkbox"/> Front cover KRB100-36 (RB100) KRB400-36 (RB400/500) KRB900-36 (RB900)	1	Optional (sold separately)	
<input type="checkbox"/> CT (Current transformer for heater break alarm) CTL-6-P-N [for 0 to 30 A] or CTL-12-S56-10L-N [for 0 to 100 A]	Depending on the order quantity	Optional (sold separately)	
<input type="checkbox"/> 250 Ω shunt resistor for current input KD100-55	Depending on the order quantity	Optional (sold separately)	



If any of the products are missing, damaged, or if your manual is incomplete, please contact RKC sales office or the agent.

1.4 Model Code

Check that the product received is correctly specified by referring to the following model code list:
If the product is not identical to the specifications, please contact RKC sales office or the agent.

■ Suffix code

RB100
RB400
RB500 □ □ □ □ - □ □ - □ * □ □ - □ □ / □ □ / Y
RB700
RB900 (1) (2) (3)(4) (5) (6)(7) (8)(9) (10)(11) (12)

Specifications		Suffix code											
		(1)	(2)	(3)	(4)	(5)	(6)	(7)	(8)	(9)	(10)	(11)	(12)
Control Method	PID control with AT (Reverse action)	F											
	PID control with AT (Direct action)	D											
	Heat/Cool PID control with AT	G											
	Heat/Cool PID control with AT (for Extruder [air cooling])	A											
	Heat/Cool PID control with AT (for Extruder [water cooling])	W											
Measured input and Range	Refer to Input Range Code Table.	□□□											
Output 1 (OUT1) [Control output]	Relay contact output			M									
	Voltage pulse output			V									
	Voltage output (0 to 5 V DC)			4									
	Voltage output (0 to 10 V DC)			5									
	Voltage output (1 to 5 V DC)			6									
	Current output (0 to 20 mA DC)			7									
	Current output (4 to 20 mA DC)			8									
	Triac output			T									
	Open collector output			D									
Output 2 (OUT2) [Cool output or transmission output] ^{1,2}	None			N									
	Refer to Output 2 Code Table.			□									
Power supply voltage	24 V AC/DC				3								
	100 to 240 V AC				4								
Digital output (DO1 to DO4) ³	None					N							
	1 point (DO1)					1							
	2 points (DO1, DO2)					2							
	4 points (DO1 to DO4) *					4							
Current transformer (CT) input	None						N						
	CTL-6-P-N (for 0 to 30 A) 1 point *						P						
	CTL-12-S56-10L-N (for 0 to 100 A) 1 point *						S						
	CTL-6-P-N (for 0 to 30 A) 2 points *						T						
	CTL-12-S56-10L-N (for 0 to 100 A) 2 points *						U						
Communication function/ Digital input (DI)	None						N						
	RS-485 (RKC communication)						5						
	RS-485 (Modbus)						6						
	Digital input (2 points)						A						
	RS-485 (RKC communication) + Digital input (2 points) *						B						
RS-485 (Modbus) + Digital input (2 points) *						C							
Waterproof/Dustproof	None						N						
	Waterproof/Dustproof (NEMA 4X, IP66)						1						
Case color	White									N			
	Black									A			
Quick start code	None (No need to specify initial setting code)										N		
	Specify quick start code (Refer to ■ Quick start code)										1		
Instrument version	Version symbol												Y

¹ Transmission output can be specified as output 2 (OUT2), when Control Method is "F" (reverse action) or "D" (direct action).

² For RB100, Output 2 (OUT2) can be specified as event output 3, when Control Method is "F" (reverse action) or "D" (direct action) and two digital outputs (DO1 and DO2) are specified.

³ For RB400/500/700/900, the maximum number of digital outputs (DO) depends on output types of OUT1 and OUT2. Refer to the table of the maximum number of DO below.

Table of the maximum number of DO:

		OUT2 (Including transmission output)					
		No OUT2 output	M, V, D	V (10 mA)	V (20 mA)	Current output	Voltage output
OUT1 *	M (Relay contact output), V (Voltage pulse output), D (Open collector output)	4	4	4	4	4	4
	V (Voltage pulse output) [Load: 10 mA]	4	4	4	4	2 **	2 **
	V (Voltage pulse output) [Load: 20 mA]	4	4	4	2 **	2 **	2 **
	Current output	4	4	2 **	2 **	2 **	2 **
	Voltage output	4	4	2 **	2 **	2 **	2 **

* When the instrument has two digital outputs (DO1 and DO2) and no OUT2 output, "V" type output (load: 40 mA) can be specified for OUT1.

** Digital outputs DO3 and DO4 cannot be specified.

1. OUTLINE

● Input Range Code Table

[Thermocouple input (Temperature input group)] *

Type	Code	Range (Measured range)	Code	Range (Measured range)
K	K01	0 to 200 °C	K43	-199.9 to +400.0 °C
	K02	0 to 400 °C	K09	0.0 to 400.0 °C
	K03	0 to 600 °C	K10	0.0 to 800.0 °C
	K04	0 to 800 °C	KA1	0 to 800 °F
	K05	0 to 1000 °C	KA2	0 to 1600 °F
	K06	0 to 1200 °C	KC7	-328 to +2501 °F
	K41	-200 to +1372 °C	KC8	-100.0 to +752.0 °F
J	J01	0 to 200 °C	J15	-200 to +1200 °C
	J02	0 to 400 °C	J07	-199.9 to +300.0 °C
	J03	0 to 600 °C	JA1	0 to 800 °F
	J04	0 to 800 °C	JA2	0 to 1600 °F
	J05	0 to 1000 °C	JB9	-328 to +2192 °F
	J06	0 to 1200 °C	JC8	-199.9 to +550.0 °F
T	T02	-199.9 to +100.0 °C	TC7	0.0 to 600.0 °F
	T03	-100.0 to +200.0 °C	TC8	-199.9 to +300.0 °F
	T05	-199.9 to +300.0 °C	TC9	-328 to +752 °F
	T06	0.0 to 400.0 °C		
E	E01	0 to 800 °C	EA1	0 to 1600 °F
	E02	0 to 1000 °C	EA2	0 to 1832 °F
S	S02	0 to 1769 °C	SA2	0 to 3216 °F
R	R02	0 to 1769 °C	RA2	0 to 3216 °F
B	B01	400 to 1800 °C	BA1	800 to 3200 °F
	B02	0 to 1820 °C	BA2	0 to 3308 °F
N	N01	0 to 1200 °C	NA1	0 to 2300 °F
	N02	0 to 1300 °C	NA2	0 to 2372 °F
PLII	A01	0 to 1300 °C	AA1	0 to 2400 °F
	A02	0 to 1390 °C	AA2	0 to 2534 °F
W5Re/W26Re	W01	0 to 2000 °C	WA4	0 to 4208 °F
	W02	0 to 2320 °C		

* Universal input within each input group

** For current input, connect is a 250 Ω shunt resistor to the input terminals.

[Resistance temperature detector input (Temperature input group)] *

Type	Code	Range (Measured range)	Code	Range (Measured range)
Pt100	D01	-199.9 to +649.0 °C	DA2	-199.9 to +400.0 °F
	D02	-199.9 to +200.0 °C	DA3	-199.9 to +200.0 °F
	D03	-100.0 to +50.0 °C	DA4	-199.9 to +100.0 °F
	D04	-100.0 to +100.0 °C	DA5	-199.9 to +300.0 °F
	D05	-100.0 to +200.0 °C	DA6	0.0 to 100.0 °F
	D06	0.0 to 50.0 °C	DA7	0.0 to 200.0 °F
	D07	0.0 to 100.0 °C	DA8	0.0 to 400.0 °F
	D08	0.0 to 200.0 °C	DA9	0.0 to 500.0 °F
	D09	0.0 to 300.0 °C	DB2	-199.9 to +900.0 °F
	D10	0.0 to 500.0 °C		
JPt100	P01	-199.9 to +649.0 °C	P06	0.0 to 50.0 °C
	P02	-199.9 to +200.0 °C	P07	0.0 to 100.0 °C
	P03	-100.0 to +50.0 °C	P08	0.0 to 200.0 °C
	P04	-100.0 to +100.0 °C	P09	0.0 to 300.0 °C
	P05	-100.0 to +200.0 °C	P10	0.0 to 500.0 °C

[Voltage input/Current input (Voltage/Current input group)] *

Type	Code	Range (Measured range)
0 to 1 V DC	301	Programmable range -1999 to +9999 [The decimal point position is selectable] (Factory set value: 0.0 to 100.0 %)
0 to 5 V DC	401	
0 to 10 V DC	501	
1 to 5 V DC	601	
0 to 20 mA DC **	701	
4 to 20 mA DC **	801	

● Output 2 Code Table

Output type	Code	Remarks
Relay contact output [Cool output]	M	—
Voltage pulse output [Cool output]	V	—
Voltage output (0 to 5 V DC) [Cool output]	4	—
Voltage output (0 to 10 V DC) [Cool output]	5	—
Voltage output (1 to 5 V DC) [Cool output]	6	—
Current output (0 to 20 mA DC) [Cool output]	7	—
Current output (4 to 20 mA DC) [Cool output]	8	—
Triac output [Cool output]	T	—
Open collector output [Cool output]	D	—

Output type	Code	Remarks
Relay contact output [Event 3 output]	P	Only RB100 (PID control)
Current output (0 to 20 mA DC) [Transmission output]	R	Only PID control
Current output (4 to 20 mA DC) [Transmission output]	S	
Voltage output (0 to 5 V DC) [Transmission output]	X	
Voltage output (0 to 10 V DC) [Transmission output]	Y	
Voltage output (1 to 5 V DC) [Transmission output]	Z	

■ Quick start code (Initial setting code)

Quick start code tells the factory to ship with each parameter preset to the values detailed as specified by the customer. Quick start code is not necessarily specified when ordering, unless the preset is requested. These parameters are software selectable items and can be re-programmed in the field following procedures found in the manual.

□ □ □ □ — □
(A) (B) (C) (D) (E)

Specifications		Quick start code (Initial setting code)				
		(A)	(B)	(C)	(D)	(E)
Digital output 1 (DO1) (Event function 1)	None	N				
	Deviation high	A				
	Deviation low	B				
	Deviation high/low	C				
	Band	D				
	Deviation high with hold action	E				
	Deviation low with hold action	F				
	Deviation high/low with hold action	G				
	Process high	H				
	Process low	J				
	Process high with hold action	K				
	Process low with hold action	L				
	Deviation high with re-hold action	Q				
	Deviation low with re-hold action	R				
	Deviation high/low with re-hold action	T				
	Band (High/Low individual setting)	U				
	SV high	V				
	SV low	W				
	Deviation high/low (High/Low individual setting)	X				
	Deviation high/low with hold action (High/Low individual setting)	Y				
	Deviation high/low with re-hold action (High/Low individual setting)	Z				
	Heater break alarm (HBA)	1				
	Control loop break alarm (LBA) ¹	2				
FAIL	3					
Monitor during RUN	4					
Output of the communication monitoring result	5					
Digital output 2 (DO2) (Event function 2)	None		N			
	Event function 2 (The code is same as Event function 1)		□			
Digital output 3 (DO3) ² (Event function 3)	None			N		
	Event function 3 (The code is same as Event function 1)			□		
Digital output 4 (DO4) ³ (Event function 4)	None				N	
	Event function 4 (The code is same as Event function 1)				□	
Digital input (DI) function assignment	None				N	
	SV1 to SV4 select				1	
	SV1 to SV2 select + RUN/STOP transfer				2	
	SV1 to SV2 select + AUTO/MAN transfer				3	
	SV1 to SV2 select + Interlock release				4	
	RUN/STOP transfer + AUTO/MAN transfer				5	
	RUN/STOP transfer + Interlock release				6	
AUTO/MAN transfer + Interlock release				7		

¹ For Heat/Cool control type, the LBA function cannot be specified.

² In case of RB100, this code is selectable when "P" is specified for "(4) output 2 (OUT2)."

³ In case of RB100, this code must be "N: None."

1.5 Parts Description

This section describes various display units and the key functions.

■ Front Panel View

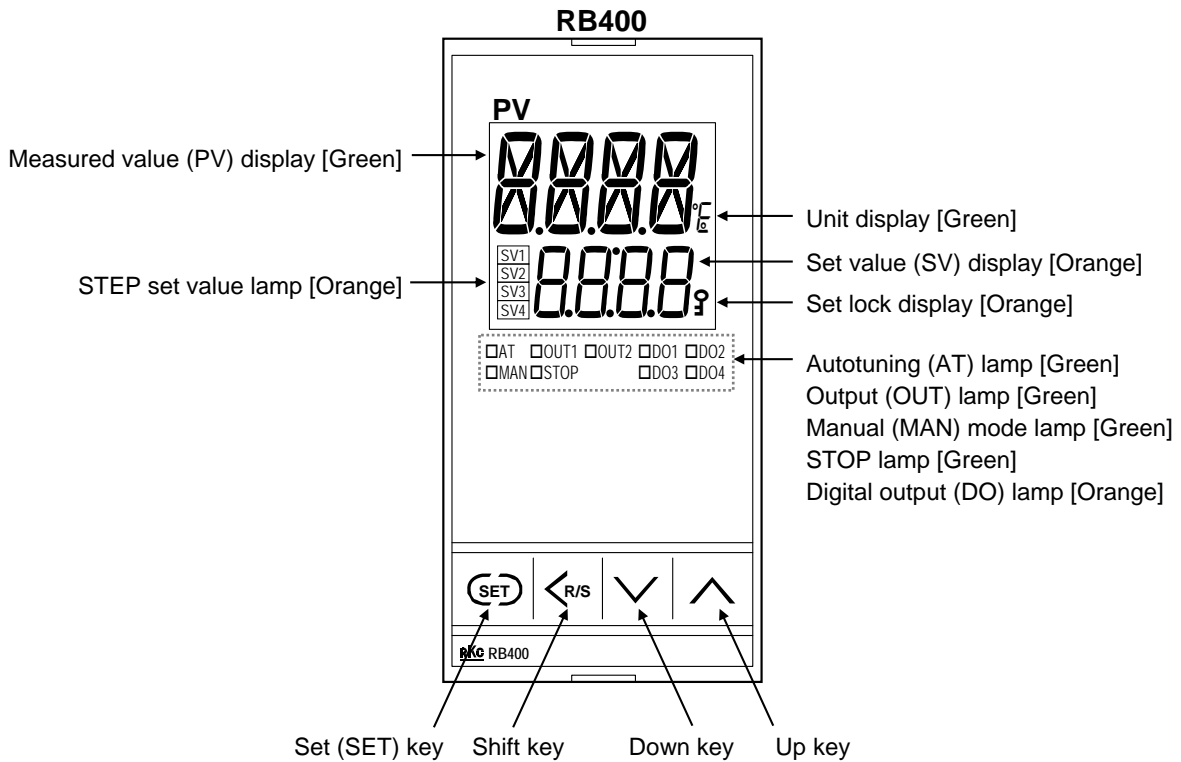
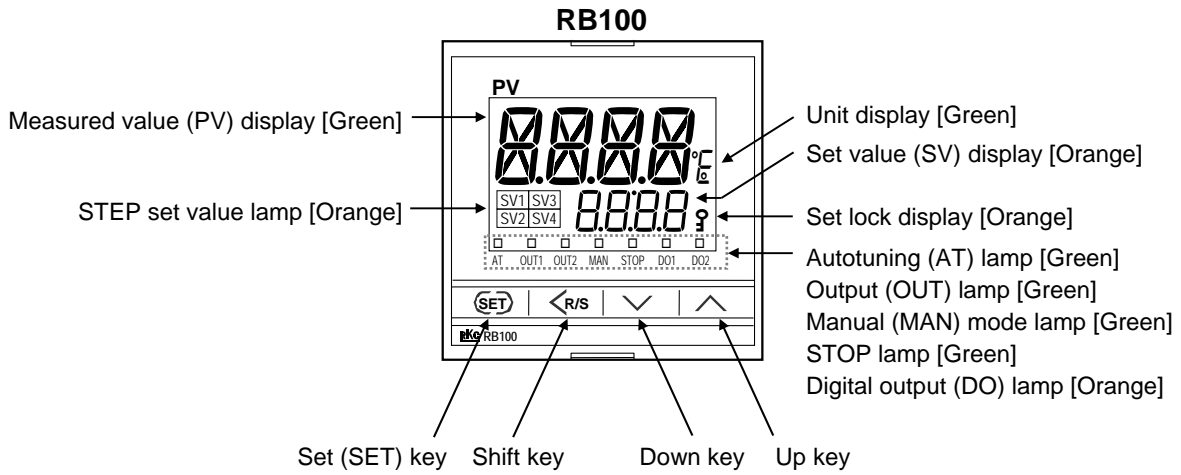

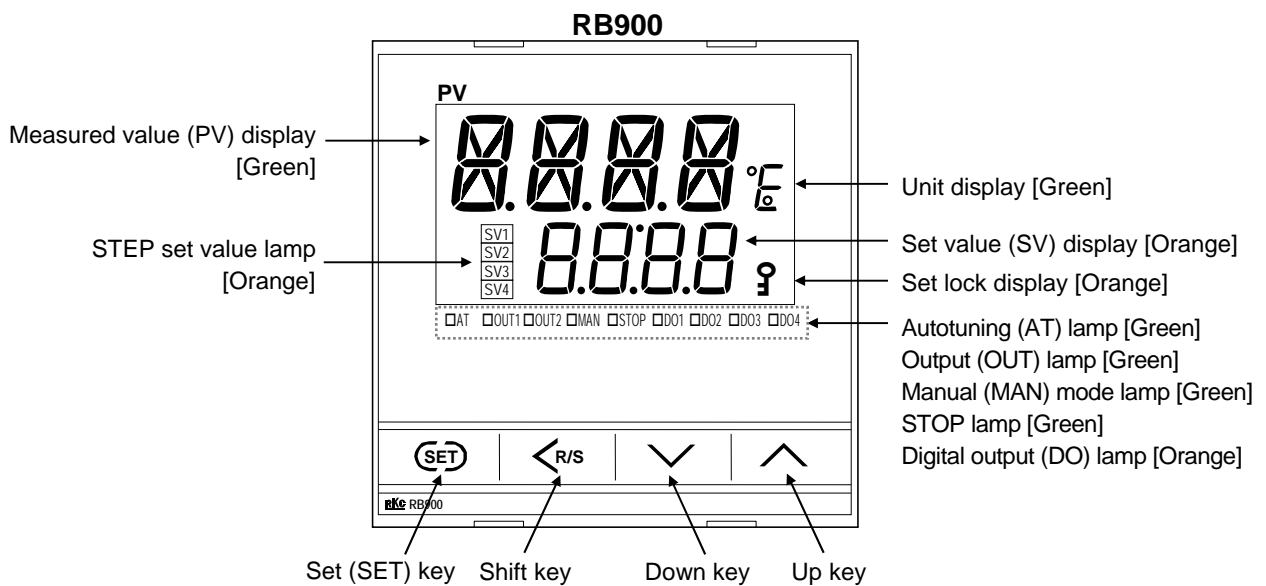
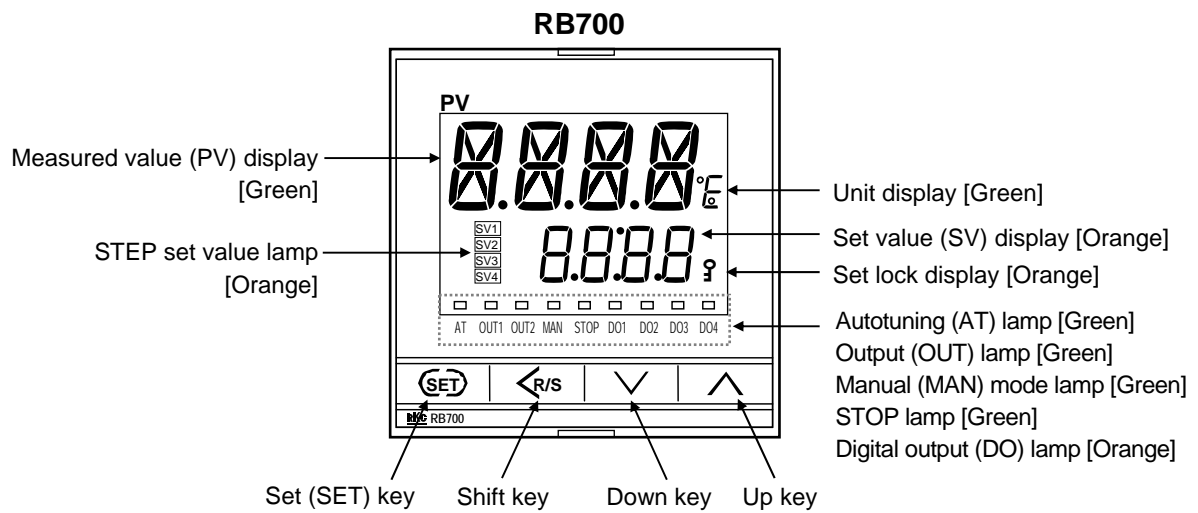
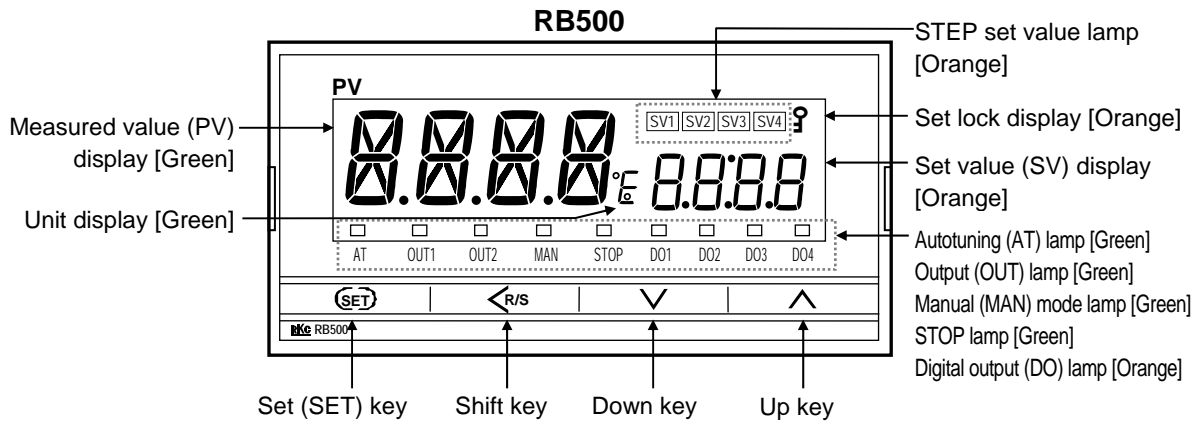





● Display units

Measured value (PV) display	[Green]	Displays Measured value (PV) or various parameter symbols.
Unit display	[Green]	Displays the temperature units (°C or °F) of displayed data and the units (%) of the Manipulated output value (MV).
Set value (SV) display	[Orange]	Displays Set value (SV), Manipulated output value (MV) or various parameter set values.
Set lock display	[Orange]	Lights when the settings are locked.

● Indication lamps

Autotuning (AT) lamp	[Green]	Flashes when Autotuning is activated. (After Autotuning is completed: AT lamp will go out) Light during Startup tuning (ST) execution.
Output (OUT) lamp	[Green]	OUT1: Lights when output 1 is turned on. OUT2: Lights when output 2 is turned on. ● Lamp indication becomes as follows for current output and voltage output. For an output of less than 0 %: Extinguished For an output of more than 0 %: Lit
Manual (MAN) mode lamp	[Green]	Lights when operated in Manual (MAN) mode.
STOP lamp	[Green]	Lights when control is stopped (STOP). Blinks when control is stopped (STOP) by the Timer function (P. 7-5).
Digital output (DO) lamp	[Orange]	Lights when the Event (RB100: DO1, DO2 RB400/500/700/900: DO1 to DO4) output corresponding to each lamp is ON.
STEP set value lamp	[Orange]	When the Step SV function (P. 7-2) or the Timer function (P. 7-5) is used, the lamp corresponding to the currently used Set value (SV1 to SV4) lights.

● Operation keys

	Set (SET) key	Used for calling up parameters and set value registration.
	Shift key	Shifts digits when settings are changed. Used to switch monitor items, RUN/STOP, and modes.
	Down key *	Decreases numerals.
	Up key *	Increases numerals.

* Also used to switch items within Mode switching (AUTO/MAN, Set data lock, and Interlock release).



To avoid damage to the instrument, never use a sharp object to press keys.

■ Bottom View

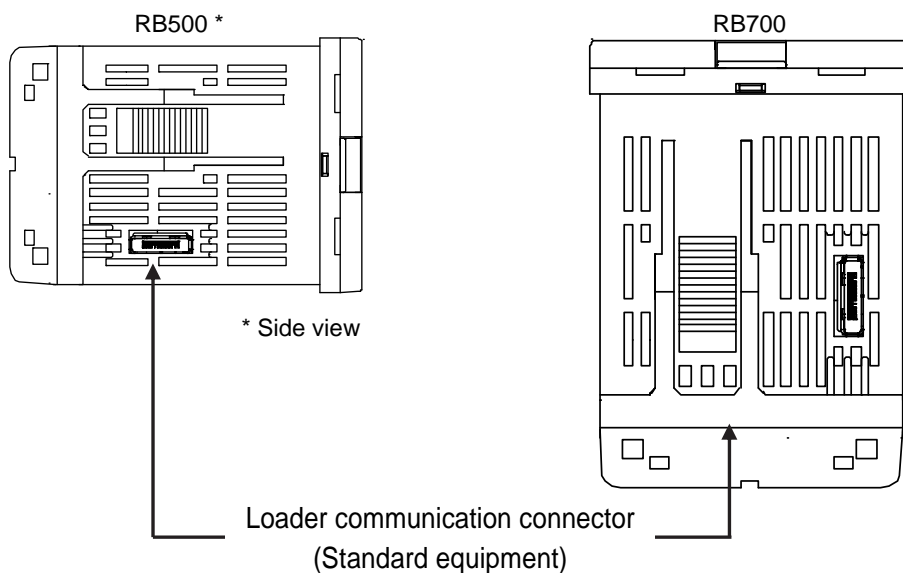
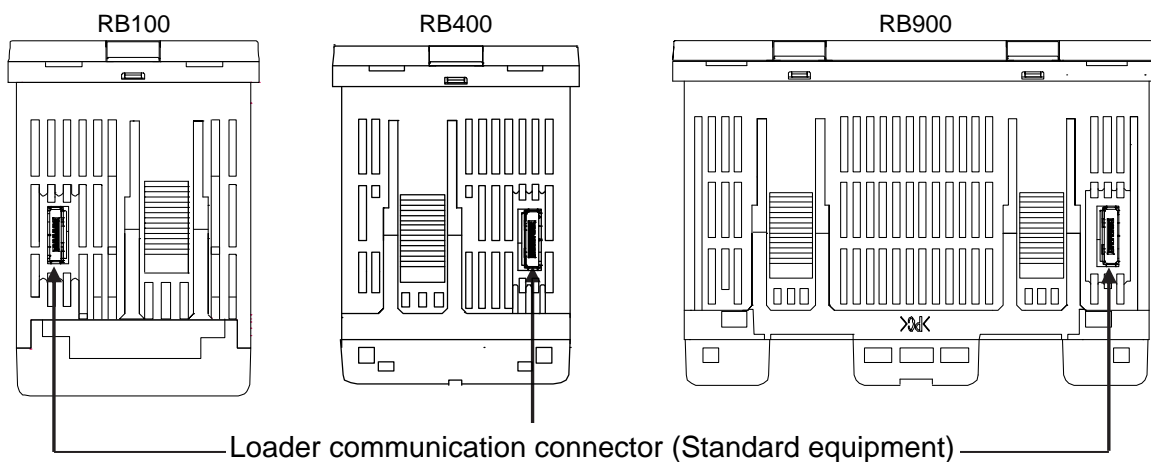

<p>Loader communication connector (Standard equipment)</p>	<p>Setting and monitoring on a personal computer (PC) is possible if the controller is connected with our cable to a PC via our USB communication converter COM-K2-1 (sold separately)¹. Our communication software² must be installed on the PC.</p> <p>¹ For the COM-K2, refer to COM-K2 Instruction Manual.</p> <p>² Only available as a download from the official RKC website. https://www.rkcinst.com/</p>
--	--

Continued on the next page.

● **How to connect the controller to a PC via loader communication port**

Connect the controller, COM-K2, and personal computer using a USB cable and a loader communication cable. Make sure the connectors are oriented correctly when connecting.

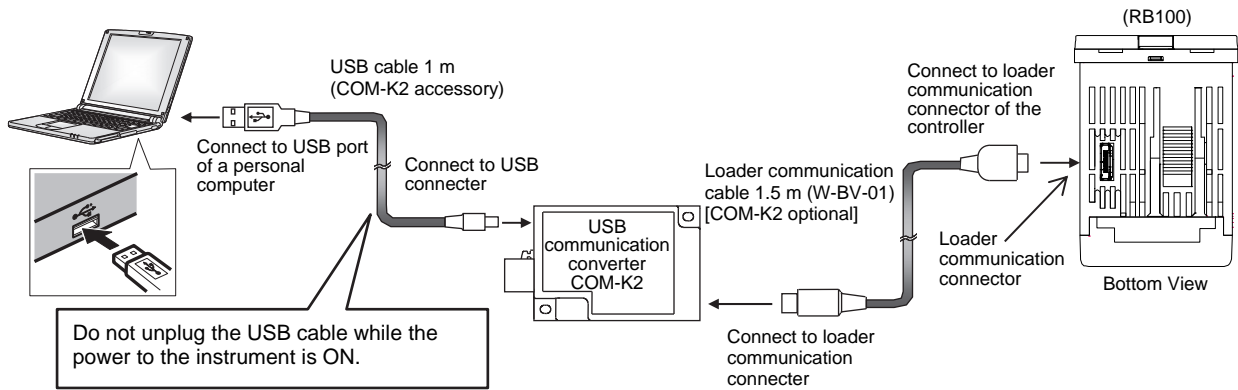

- Communication tool PROTEM2
Software operation environment:
Consult the manual that you downloaded
- Communication tool WinUCI
Software operation environment:
Windows 98SE/2000/X
- Communication tool WinSCI
Software operation environment:
Windows 95 or higher
- Communication port of host computer
USB port: Based on USB Ver. 2.0

- Communication settings on the computer
(The following values are all fixed)
Communication speed: 9600 bps
Start bit: 1
Data bit: 8
Parity bit: Without
Stop bit: 1

The device address for loader communication is fixed at "0."
The setting of the device address is disregarded.



The Loader port is only for parameter setup.



Loader communication can be used on a controller even when the Communication function (optional) is not installed.



The loader communication corresponds to the RKC communication protocol "Based on ANSI X3.28-1976 subcategories 2.5 and A4."



When using the loader communication, USB driver for COM-K2 must be installed on the personal computer.

The USB driver for COM-K2 can be downloaded the official RKC website:

<https://www.rkcinst.com/>



A previous version of COM-K (version 1) can be also used.

However, if communication tool PROTEM2 is used using a COM-K, the PROTEM2 will not be supported by Windows 8 or later.

1.6 Handling Procedure to Operation

After installation and wiring, follow the procedure below to configure settings required for operation.

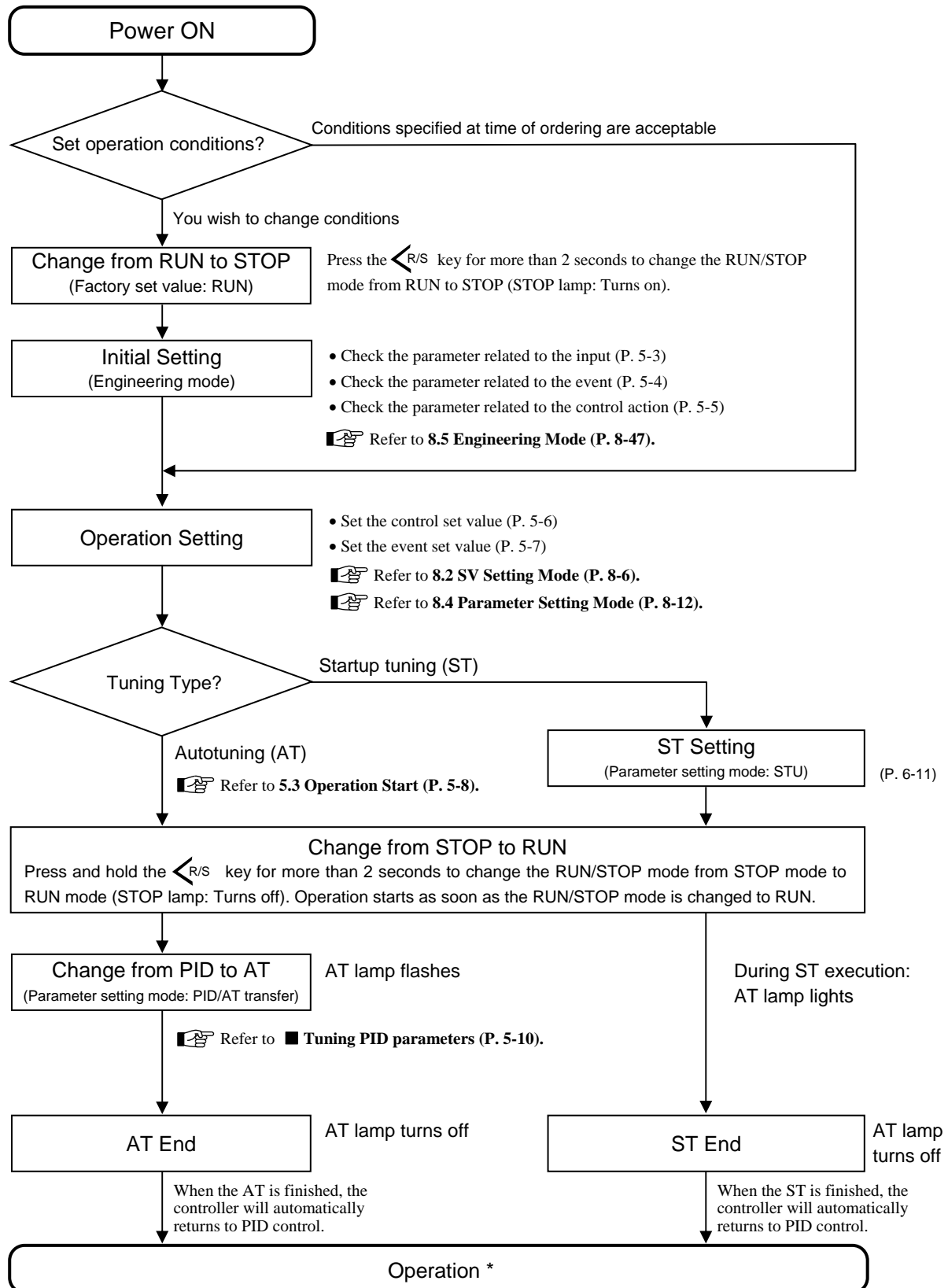

* Adjust the PID constants manually when the optimum PID constants cannot be calculated by AT or ST for characteristic variations of the controlled system.

MEMO

MOUNTING

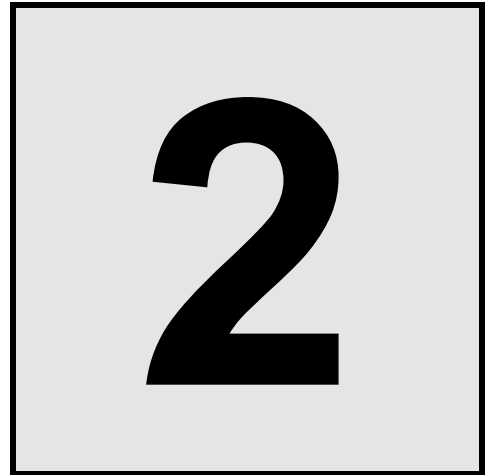

This chapter describes installation environment, mounting cautions, dimensions and mounting procedures.

2.1 Mounting Cautions.....	2-2
2.2 Dimensions.....	2-3
■ RB100.....	2-3
■ RB400.....	2-3
■ RB500.....	2-4
■ RB700.....	2-4
■ RB900.....	2-5
2.3 Procedures of Mounting and Removing.....	2-6
■ The mounting position of mounting bracket.....	2-6
■ Mounting procedures (Not supplied)	2-7
■ Mounting procedures (Waterproof/Dustproof type)	2-8
■ Removal procedures	2-9

2.1 Mounting Cautions



WARNING

To prevent electric shock or instrument failure, always turn off the power before mounting or removing the instrument.

- (1) This instrument is intended to be used under the following environmental conditions. **(IEC 61010-1)**
[OVERVOLTAGE CATEGORY II, POLLUTION DEGREE 2]
- (2) Use this instrument within the following environment conditions:
 - Allowable ambient temperature: 0 to 50 °C
 - Allowable ambient humidity: 10 to 90 %RH
(Absolute humidity: MAX.W.C 29.3 g/m³ dry air at 101.3 kPa)
 - Installation environment conditions: Indoor use
Altitude up to 2000 m
- (3) Avoid the following conditions when selecting the mounting location:
 - Rapid changes in ambient temperature which may cause condensation.
 - Corrosive or inflammable gases.
 - Direct vibration or shock to the mainframe.
 - Water, oil, chemicals, vapor or steam splashes.
 - Excessive dust, salt or iron particles.
 - Excessive induction noise, static electricity, magnetic fields or noise.
 - Direct air flow from an air conditioner.
 - Exposure to direct sunlight.
 - Excessive heat accumulation.
- (4) Mount this instrument in the panel considering the following conditions:
 - Provide adequate ventilation space so that heat does not build up.
 - Ensure at least 50 mm space on top and bottom of the instrument for maintenance and environmental reasons.
 - Do not mount this instrument directly above the equipment that generates large amount of heat (heaters, transformers, semi-conductor functional devices, large-wattage resistors.)
 - If the ambient temperature rises above 50 °C, cool this instrument with a forced air fan, cooler, etc. Cooled air should not blow directly on this instrument.
 - In order to improve safety and the immunity to withstand noise, mount this instrument as far away as possible from high voltage equipment, power lines, and rotating machinery.
 - High voltage equipment: Do not mount within the same panel.
 - Power lines: Separate at least 200 mm.
 - Rotating machinery: Separate as far as possible.
 - The view angle of this controller is 30° to the upper side and the lower side from the center of the display.
- (5) In case this instrument is connected to a supply by means of a permanent connection, a switch or circuit-breaker shall be included in the installation. This shall be in close proximity to the equipment and within easy reach of the operator. It shall be marked as the disconnecting device for the equipment.

2.2 Dimensions

Panel thickness: 1 to 10 mm

(When mounting multiple RB series controllers close together, the panel strength should be checked to ensure proper support.)

■ RB100

(Unit: mm)

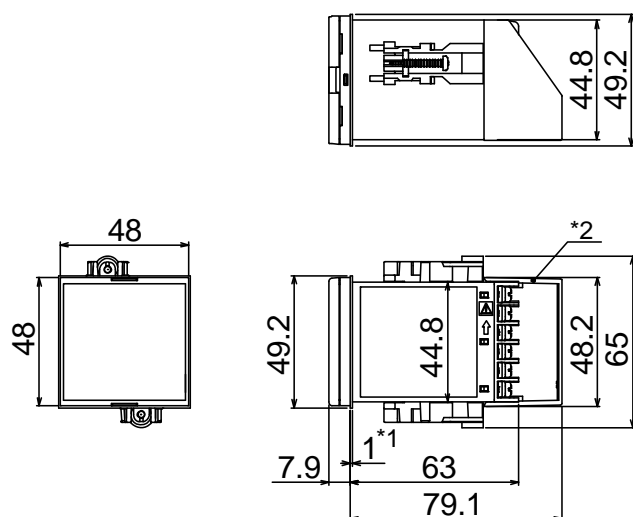

Individual mounting ^{*3}

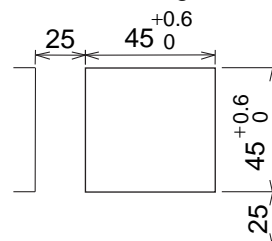

Close horizontal mounting ^{*4}

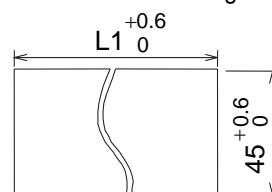

$$L1 = 48 \times n - 3$$

n = Number of controllers (2 to 6)

■ RB400

(Unit: mm)

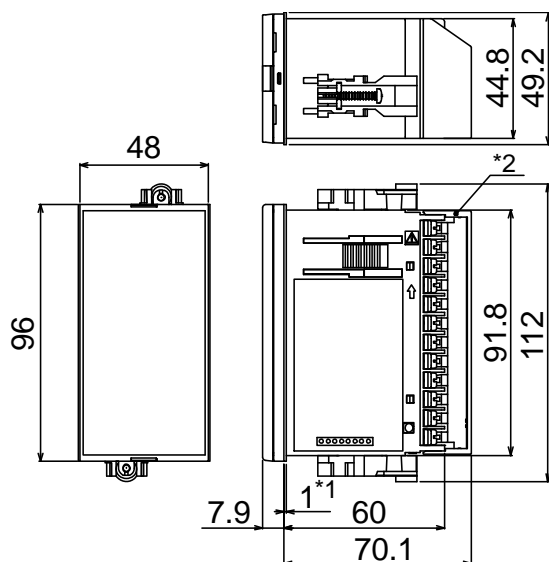

Individual mounting ^{*3}

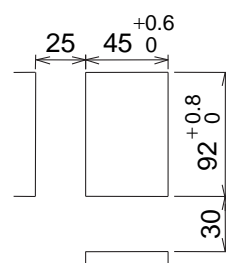

Close horizontal mounting ^{*4}

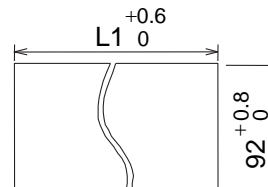

$$L1 = 48 \times n - 3$$

n = Number of controllers (2 to 6)

*1 Case rubber gasket (optional) [Waterproof/Dustproof]

*2 Terminal cover (optional) [sold separately]

*3 To keep the instrument as waterproof as possible, make sure that the panel surface has no burr or distortion where the hole is to be cut out.

*4 Remove the case rubber gasket. When the RB series is mounted closely protection will be compromised and they will not meet IP66 (NEMA4X) standards.

Panel thickness: 1 to 10 mm

(When mounting multiple RB series controllers close together, the panel strength should be checked to ensure proper support.)

■ **RB500**

(Unit: mm)

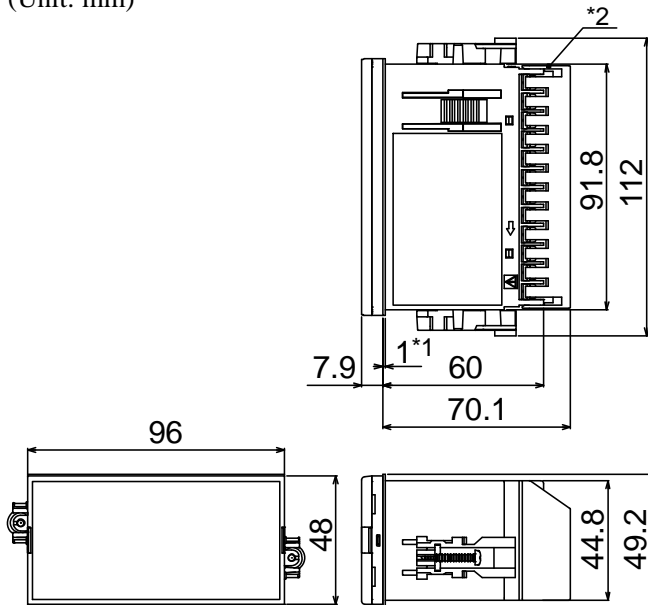

Individual mounting ^{*3}

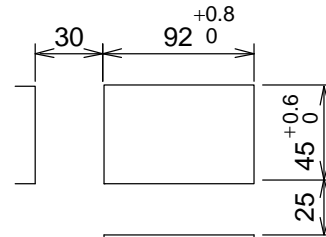

Close horizontal mounting ^{*4}

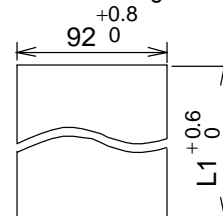

$L1 = 48 \times n - 3$

$n =$ Number of controllers (2 to 6)

■ **RB700**

(Unit: mm)

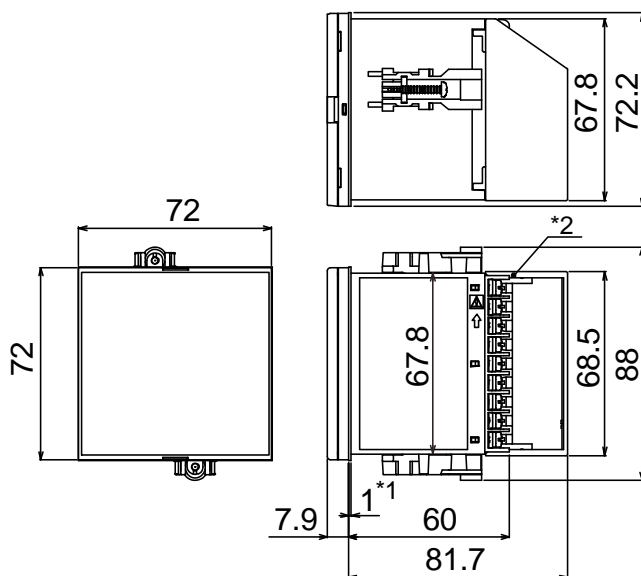

Individual mounting ^{*3}

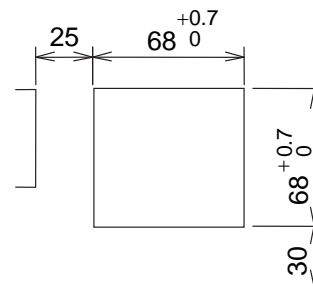

Close horizontal mounting ^{*4}

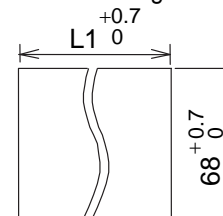

$L1 = 72 \times n - 4$

$n =$ Number of controllers (2 to 6)

*1 Case rubber gasket (optional) [Waterproof/Dustproof]

*2 Terminal cover (optional) [sold separately]

*3 To keep the instrument as waterproof as possible, make sure that the panel surface has no burr or distortion where the hole is to be cut out.

*4 Remove the case rubber gasket. When the RB series is mounted closely protection will be compromised and they will not meet IP66 (NEMA4X) standards.

Panel thickness: 1 to 10 mm

(When mounting multiple RB series controllers close together, the panel strength should be checked to ensure proper support.)

■ RB900

(Unit: mm)

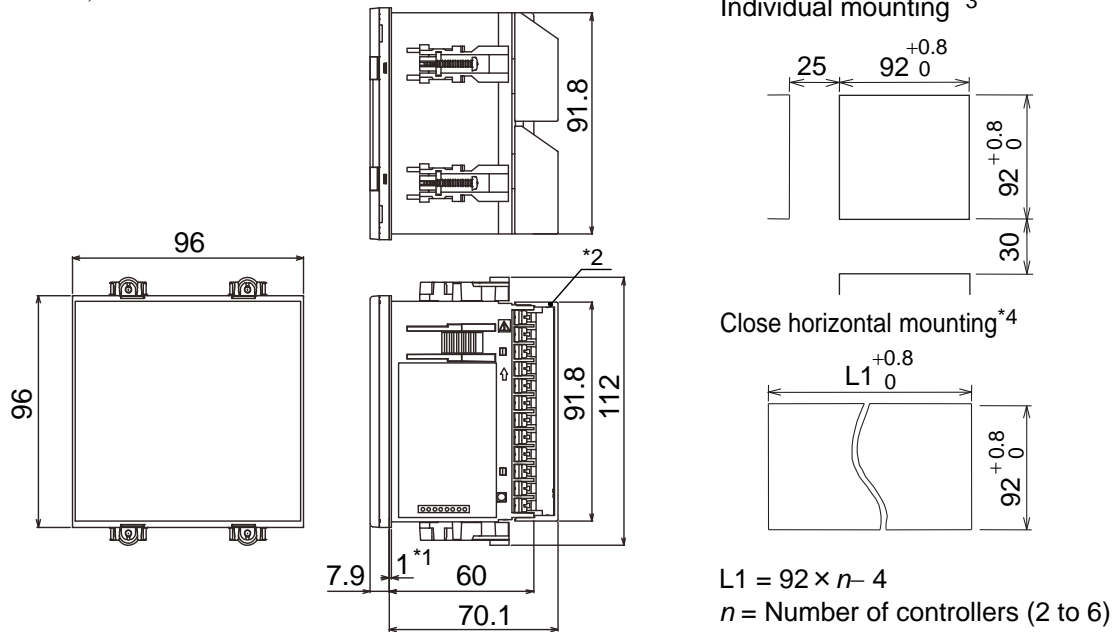

*1 Case rubber gasket (optional) [Waterproof/Dustproof]

*2 Terminal cover (optional) [sold separately]

*3 To keep the instrument as waterproof as possible, make sure that the panel surface has no burr or distortion where the hole is to be cut out.

*4 Remove the case rubber gasket. When the RB series is mounted closely protection will be compromised and they will not meet IP66 (NEMA4X) standards.

2.3 Procedures of Mounting and Removing

■ The mounting position of the mounting bracket

(1) Mounting positions for single controller

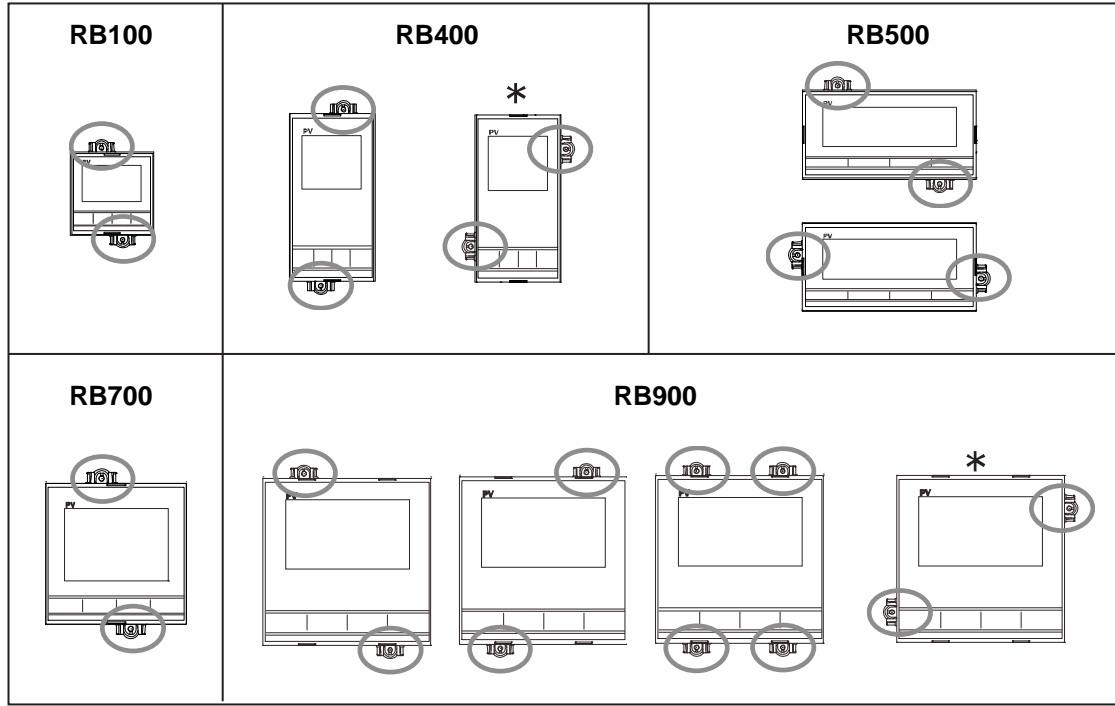

* If two mounting brackets are used on the Waterproof/Dustproof type controller as shown in the figure (marked*), sufficient Waterproof/Dustproof performance cannot be obtained.

(2) Mounting positions for close mounting

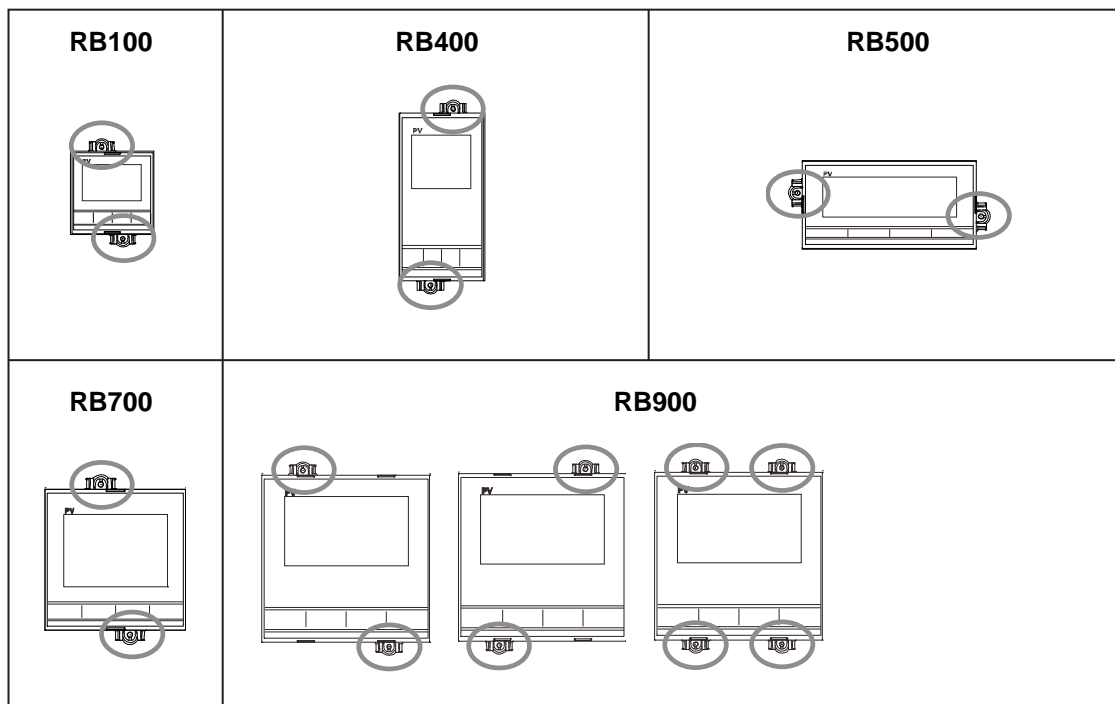

When mounting closely, the controllers are not waterproof or dustproof.

■ Mounting procedures (Not supplied)

1. Prepare the panel cutout as specified in **2.2 Dimensions**.
(Panel thickness: 1 to 10 mm)

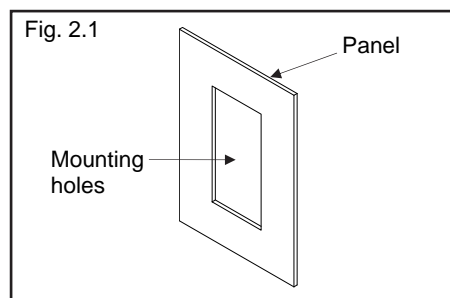

2. Insert the instrument through the panel cutout. (Fig. 2.2)

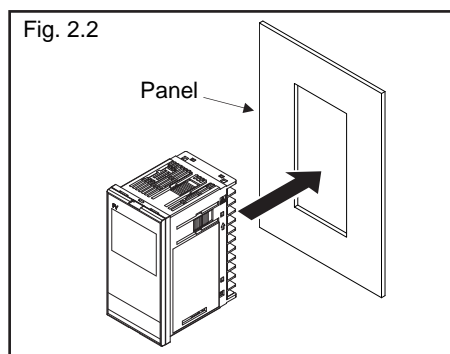

3. Insert the mounting bracket into the mounting groove of the instrument. (Fig. 2.3)
Do not push the bracket forcibly forward.

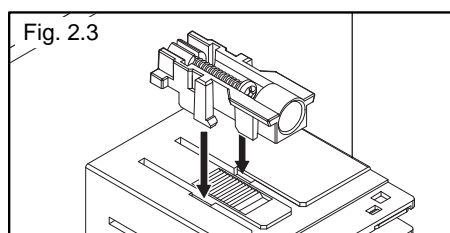

4. Tighten up the screw for the mounting bracket with a Phillips screwdriver so that the mounting bracket is firmly secured in place. (Fig. 2.4)
Give the screw another turn when the tip of the screw touches the panel.

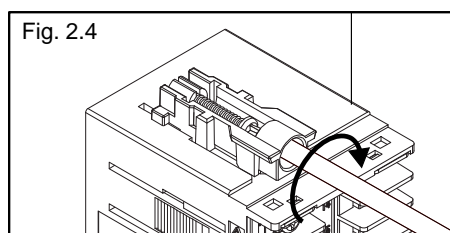

Do not overtighten the screw. It may turn idle. In case the screw has been overtightened to turn idle, loosen the screw, then tighten the screw again until the instrument is firmly fixed.

5. The other mounting bracket should be installed the same way as described in **3** and **4**.

■ Mounting procedures (Waterproof/Dustproof type)

The front of the instrument conforms to **IP66 (NEMA4X)** [Specify when ordering] when mounted on the panel. Checked and confirmed its compliance through the internal test at RKC. For effective Waterproof/Dustproof, the gasket must be securely placed between the instrument and the panel without any gap. If the gasket is damaged, please contact RKC sales office or the agent.

1. Prepare the panel cutout as specified in **2.2 Dimensions**.
(Panel thickness: 1 to 10 mm)

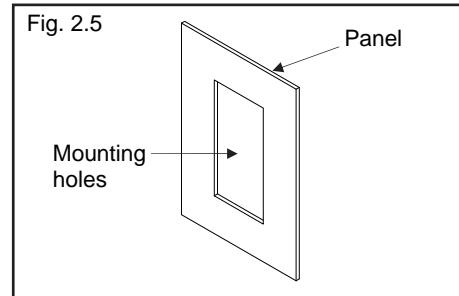

2. Set the water/dustproof rubber gasket (optional) on the case from the back side of the instrument shown in Fig. 2.6.
Insert the instrument through the panel cutout.

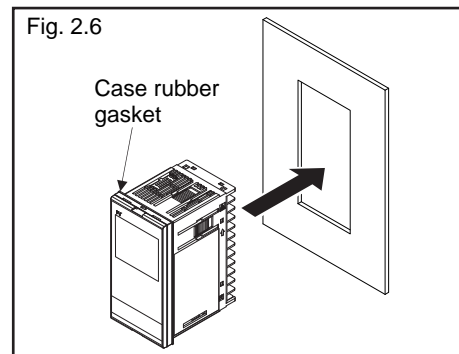

3. Insert the mounting bracket into the mounting groove of the instrument. (Fig. 2.7)
Do not push the bracket forcibly forward.



For waterproof and dustproof protection, two mounting brackets must be placed on the top and bottom side of the instrument. If the mounting brackets are placed on the sides of the controller, waterproof and dustproof protection will not be guaranteed.

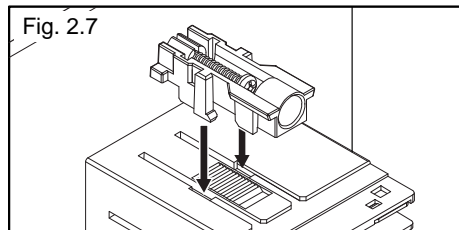

4. Tighten up the screw for the mounting bracket with a Phillips screwdriver so that the mounting bracket is firmly secured in place. (Fig. 2.8)
Give the screw another turn when the tip of the screw touches the panel.



Do not overtighten the screw. It may turn idle. In case the screw has been overtightened to turn idle, loosen the screw, then tighten the screw again until the instrument is firmly fixed.

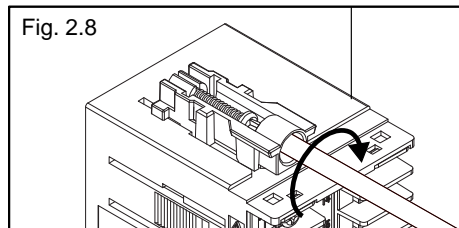

5. The other mounting bracket should be installed the same way as described in 3 and 4.



For replacing of rubber gasket, refer to **APPENDIX B. Replacing the Waterproof/Dustproof Rubber Gasket (P. A-4)**.

■ Removal procedures

1. Turn the power OFF.
2. Remove the wiring.
3. Loosen the screw of the mounting bracket.
4. Hold the rear of the mounting bracket (Fig.2.9), and lift up one side to remove it from the case. (Fig. 2.10)
5. The other mounting bracket should be removed in the same way as described in 3 and 4.

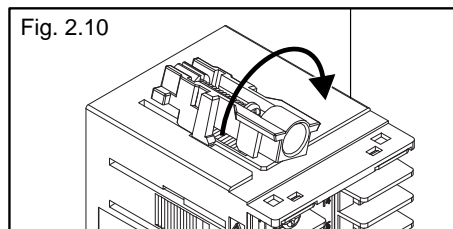
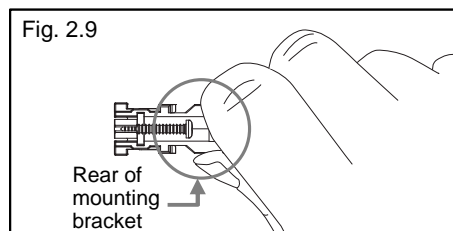

6. Pull out the instrument from the mounting cutout while holding the front panel frame of this instrument. (Fig. 2.11)

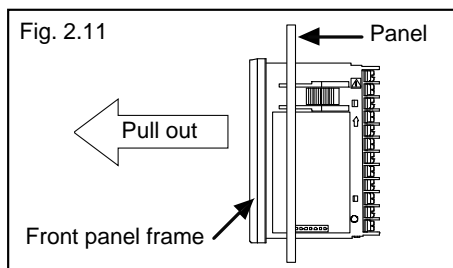

Use long-nose pliers to remove the mounting brackets from the instrument that is installed in a narrow place or installed tightly in a vertical position.

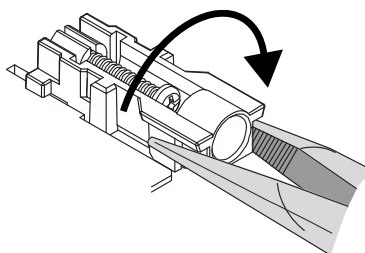

MEMO

WIRING

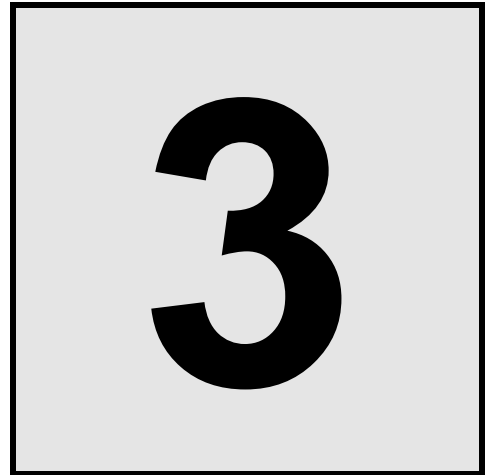

This chapter describes wiring cautions, wiring layout and wiring of terminals.

3.1 Wiring Cautions	3-2
3.2 Terminal Layout	3-5
3.3 Wiring of Each Terminal	3-8
3.4 Handling of the Terminal Cover [optional].....	3-15

3.1 Wiring Cautions



WARNING

To prevent electric shock or instrument failure, do not turn on the power until all wiring is completed. Make sure that the wiring is correct before applying power to the instrument.

- For thermocouple input, use the appropriate compensation wire.
- For RTD input, use low resistance lead wire with no difference in resistance between the three lead wires.
- Signal connected to Voltage input and Current input shall be low voltage defined as “SELV” circuit per IEC 60950-1.
- To avoid noise induction, keep input signal wire away from instrument power line, load lines and power lines of other electric equipment.
- If there is electrical noise in the vicinity of the instrument that could affect operation, use a noise filter.
 - Shorten the distance between the twisted power supply wire pitches to achieve the most effective noise reduction.
 - Always install the noise filter on a grounded panel. Minimize the wiring distance between the noise filter output and the instrument power supply terminals to achieve the most effective noise reduction.
 - Do not connect fuses or switches to the noise filter output wiring as this will reduce the effectiveness of the noise filter.
- Allow approximately 5 seconds for contact output when the instrument is turned on. Use a delay relay when the output line is used for an external interlock circuit.
- Power supply wiring must be twisted and have a low voltage drop.
- This instrument is not provided with an overcurrent protection device. For safety install an overcurrent protection device (such as a fuse) with adequate breaking capacity close to the instrument.
 - Fuse type: Time-lag fuse (Approved fuse according IEC 60127-2 and/or UL 248-14)
 - Fuse rating: Rated current: 1 A
- For the current input specification, a shunt resistor of $250 \Omega \pm 0.02 \%$ (Temperature characteristics: $\pm 10 \text{ ppm}/^\circ\text{C}$, Specified voltage: 0.25 W or more) must be connected between the input terminals.
- For an instrument with 24 V power supply input, supply power from a “SELV” circuit defined as IEC 60950-1.
- A suitable power supply should be considered in end-use equipment. The power supply must be in compliance with a limited-energy circuits (maximum available current of 8 A).

- Use the solderless terminal appropriate to the screw size.
 - Screw size: M3 \times 7 (With 5.8 \times 5.8 square washer)
 - Recommended tightening torque: 0.4 N·m (4 kgf·cm)
 - Applicable wire: Solid/twisted wire of 0.25 to 1.65 mm²
 - Specified dimension: Refer to Fig. 3.1
 - Specified solderless terminals:

Circular terminal with isolation V1.25-MS3
(M3 screw, width 5.5 mm, hole diameter 3.2 mm)

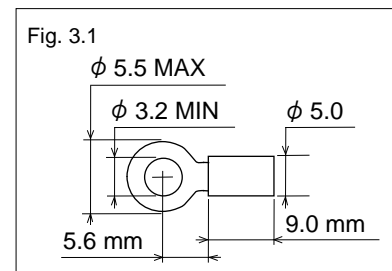

- Make sure that during field wiring parts of conductors cannot come into contact with adjacent conductive parts.

- When wiring of RB100/400/700/900, wire from the left direction toward the backside terminals as shown in Fig. 3.2.
For RB100, the wiring surfaces of the central and right side lines of terminals are inclined to make it easier to wire from the left side.
When using the terminal cover (Figs. 3.2, 3.5), it is not possible to wire from the right side.
When wiring from the left and right with a close mounting, there are cases where adjacent instruments cannot be wired.

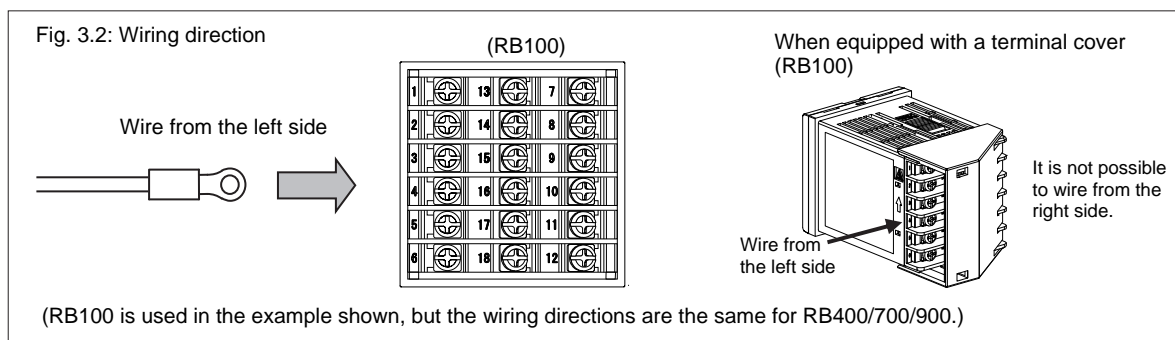

- When wiring of RB500, wire from the bottom direction toward the backside terminals as shown in Fig. 3.3.

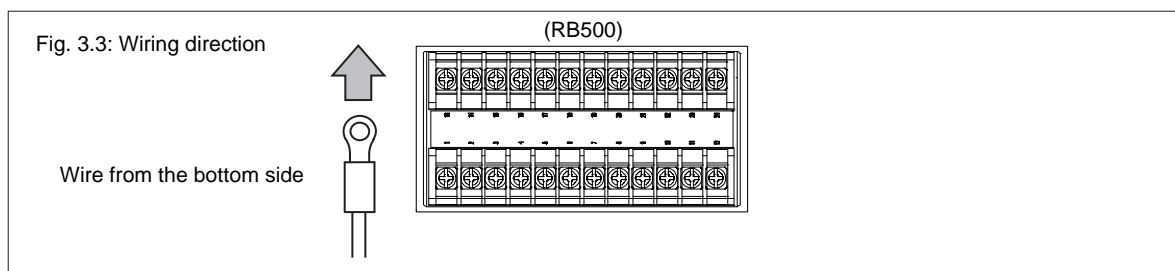

- Up to two solderless terminal lugs can be connected to one terminal screw. However, **reinforced insulation cannot be used.**

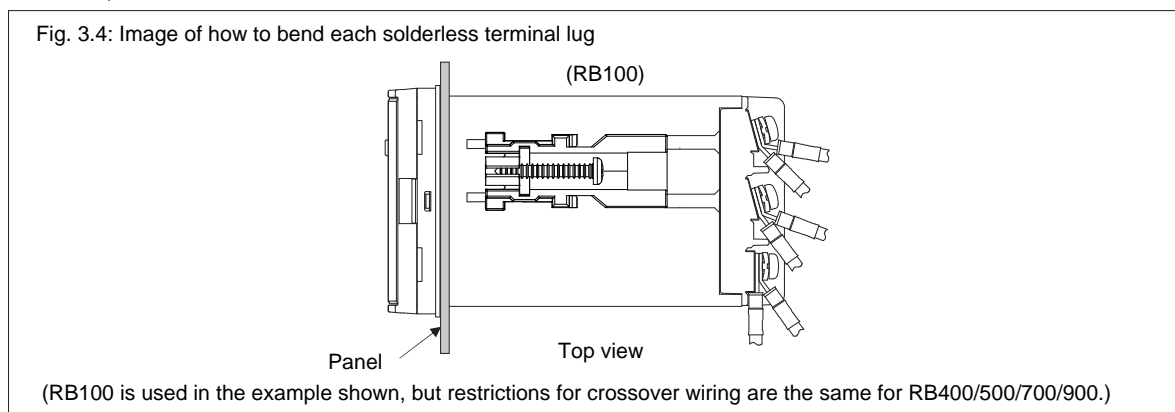

- If solderless terminal lugs other than the recommended dimensions are used, terminal screws may not tighten. In that case, bend each solderless terminal lug before wiring.
If the terminal screw is forcibly tightened, it may be damaged.
- In case of RB100, if two solderless terminal lugs are connected to one terminal screw, a terminal cover cannot be used.

Continued on the next page.



When tightening a screw of the instrument, make sure to fit the screwdriver properly into the screw head mounted tilted or flat as shown in the right figure. Tightening the screw with excessive torque may damage the screw thread.

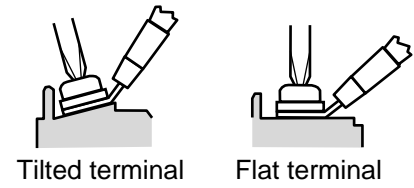

• Caution for the terminal cover usage:

- To prevent electric shock or instrument failure, always turn off the power before mounting or removing the terminal cover.
- When mounting and removing the terminal cover, apply pressure very carefully to avoid damage to the terminal cover.
- If a solderless terminal lug touches the RB400/500/900 common terminal cover, remove the projection from the terminal cover by manually bending it in front and in rear until broken. (Fig. 3.5)

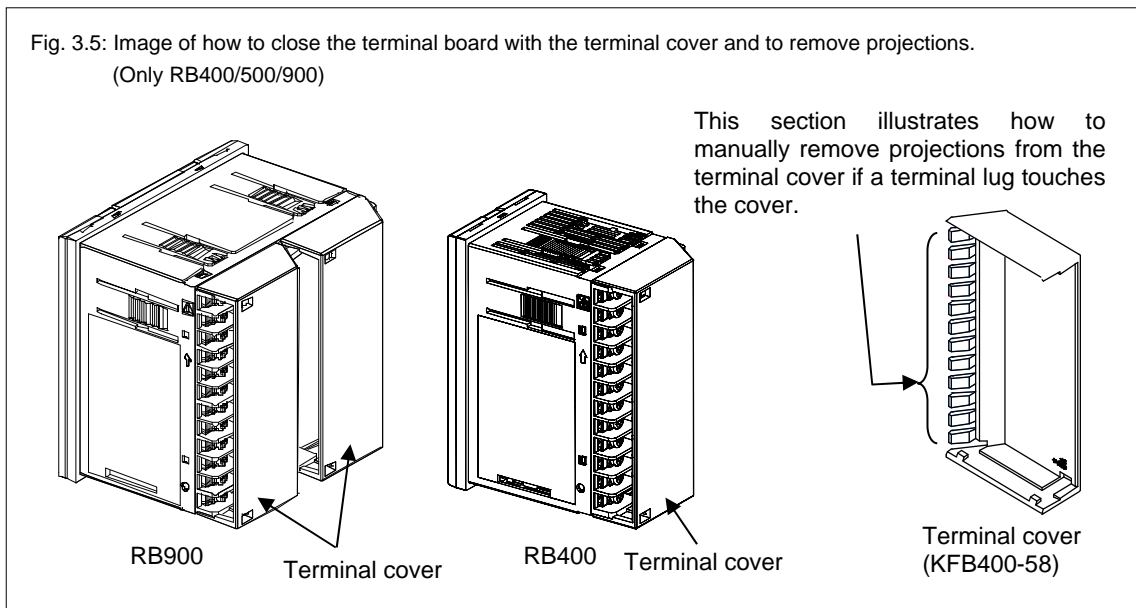

For the mounting and removing of the terminal cover, refer to **3.4 Handling of the Terminal Cover [optional] (P. 3-15)**.

3.2 Terminal Layout

The terminal layout is as follows.

■ RB100

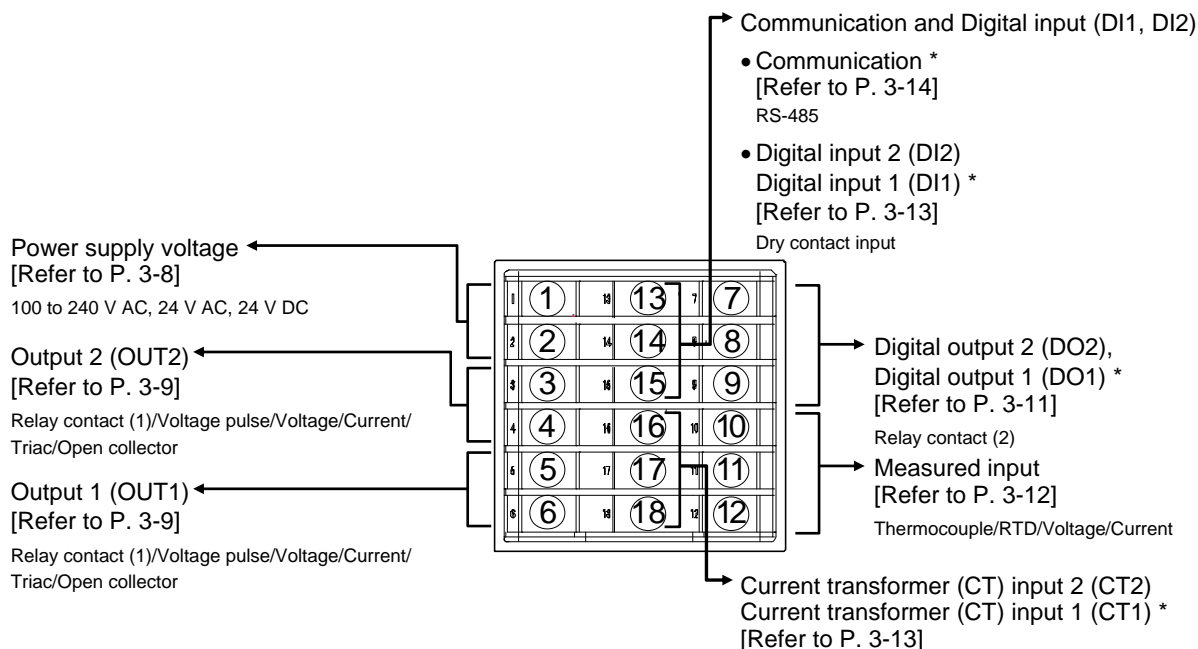

* Optional

■ RB400

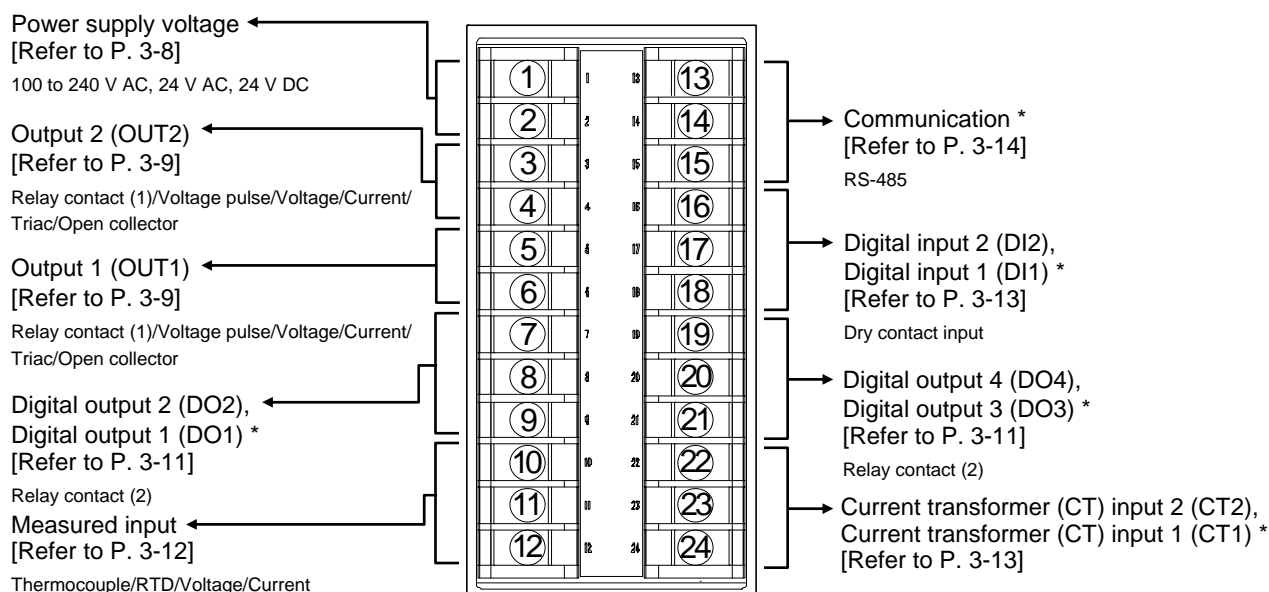

* Optional

■ **RB500**

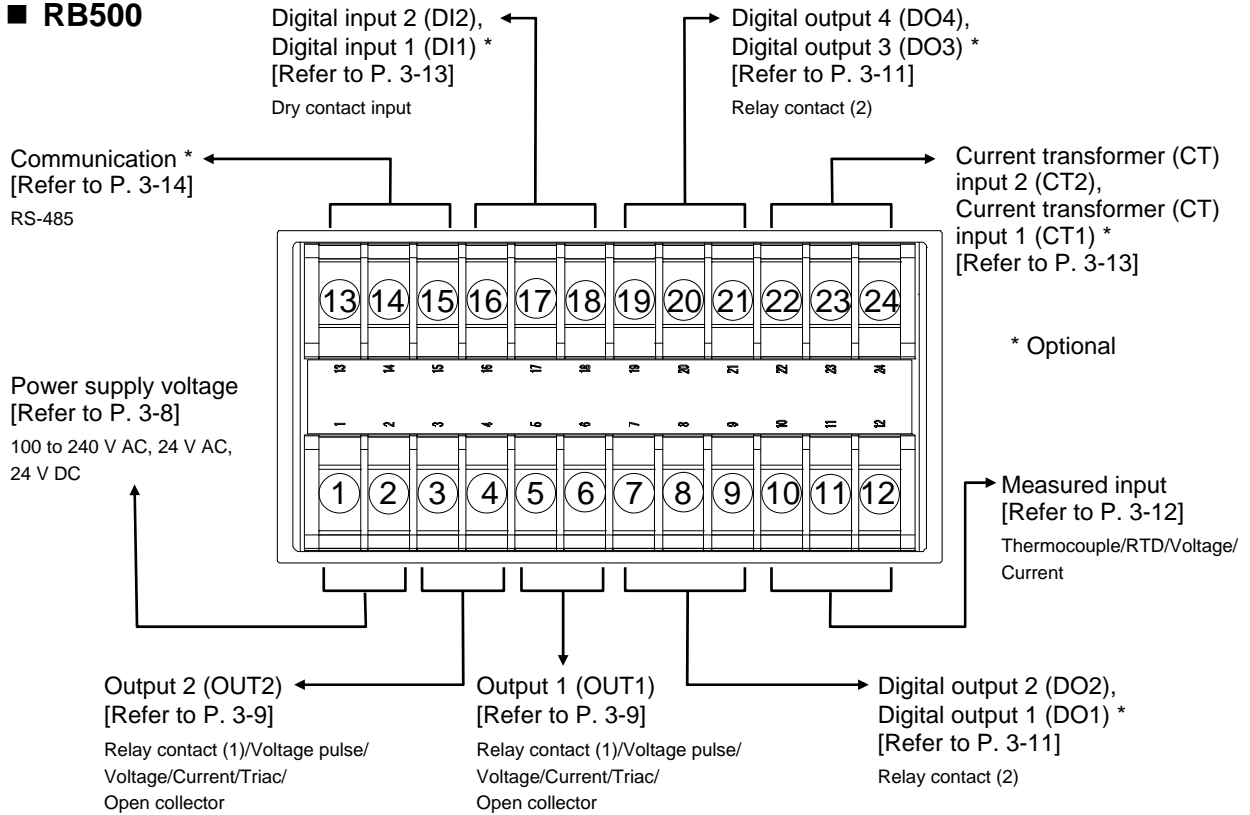

■ **RB700**

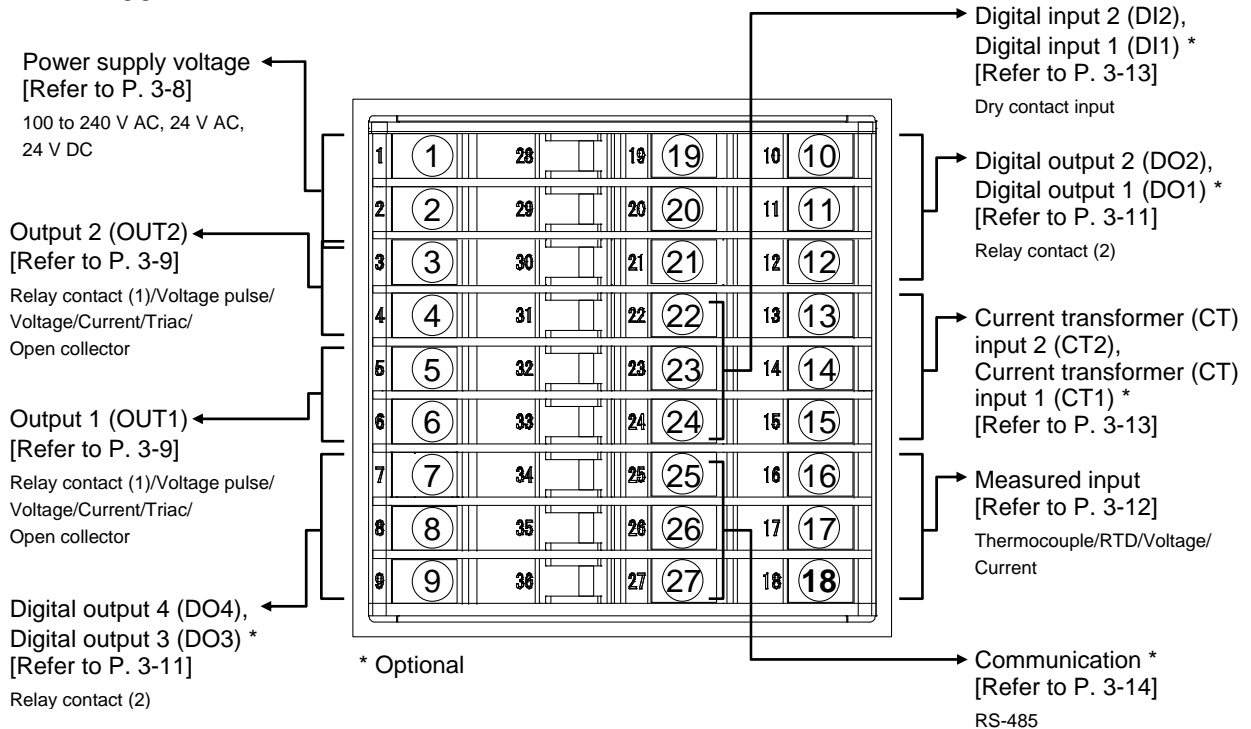

■ **RB900**

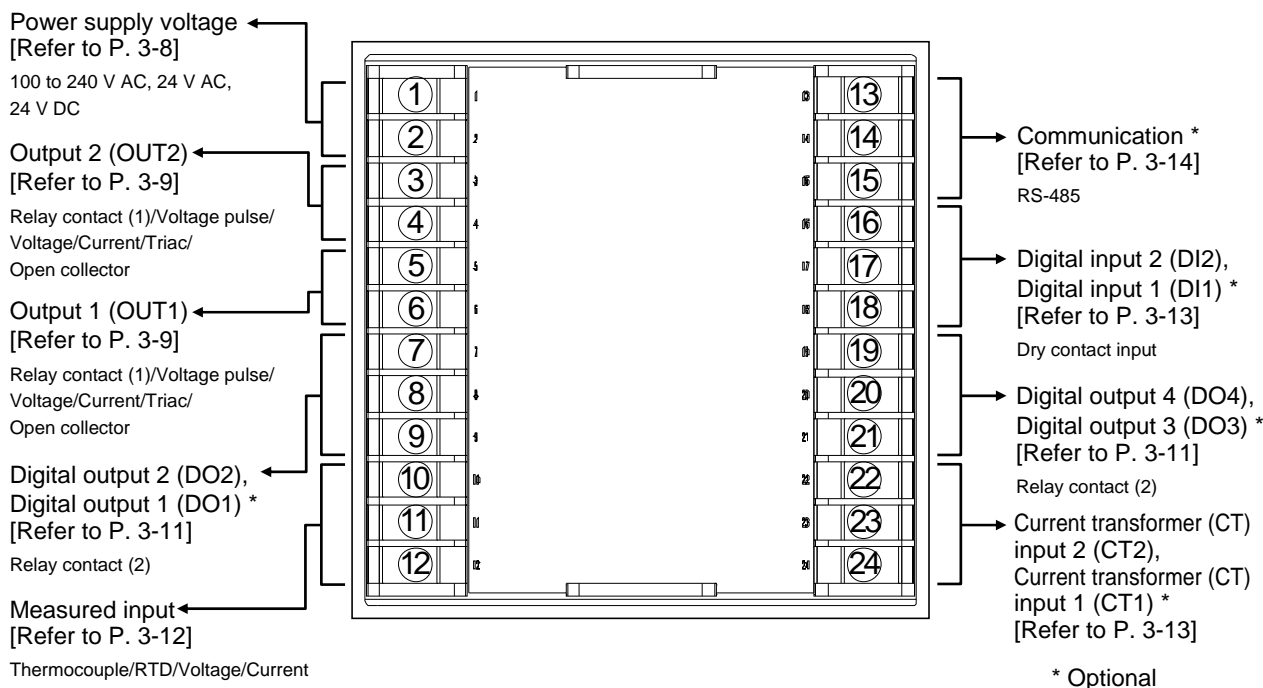

■ **Isolations of input and output**

For isolated device input/output blocks, refer to the following:

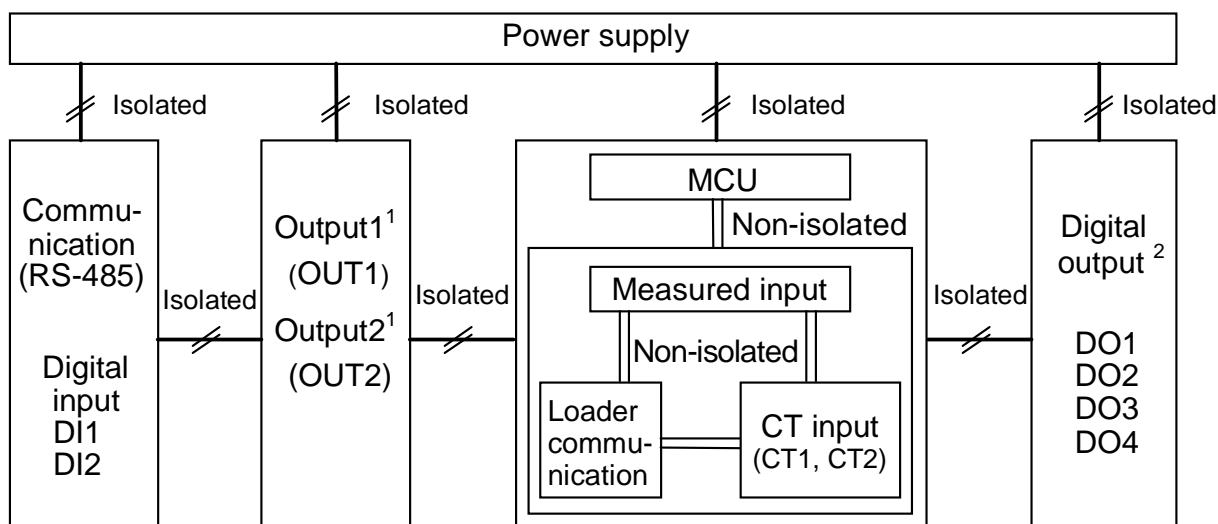

¹ Outputs are isolated if output 1 (OUT1) or output 2 (OUT2) is “relay contact output” or “triac trigger output.” If both outputs are “relay contact output” or “triac trigger output,” outputs are not isolated.

² Outputs of DO1/DO2 and DO3/DO4 are isolated. DO1 and DO2 or DO3 and DO4 use the same common terminal (No. 9 for DO1/DO2, and No. 21 for DO3/DO4) and are not isolated.

3.3 Wiring of Each Terminal

Always check the polarity of each terminal prior to wiring.

■ Power supply

- Connect the power to terminal numbers 1 and 2.

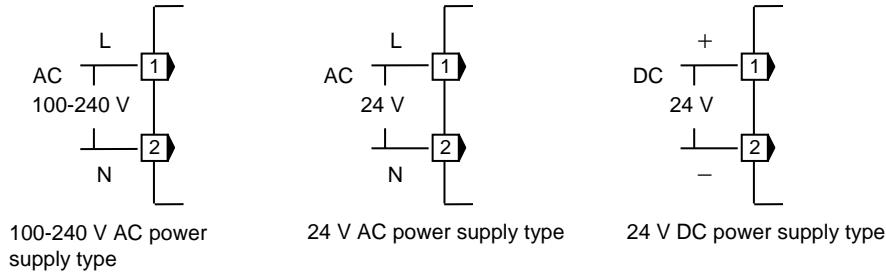

- Power supply types must be specified when ordering. Power supply voltage for the controller must be within the range shown below to assure control accuracy.

Specification code	Power supply type	Power consumption
4	90 to 264 V AC (Power supply voltage range), [Rating 100 to 240 V AC] Power supply frequency: 50/60 Hz	RB100: 5.5 VA max. (at 100 V AC), 8.5 VA max. (at 240 V AC) RB400/500/700: 6.0 VA max. (at 100 V AC), 8.7 VA max. (at 240 V AC) RB900: 6.2 VA max. (at 100 V AC), 9.0 VA max. (at 240 V AC)
3	21.6 to 26.4 V AC (Power supply voltage range), [Rating 24 V AC] Power supply frequency: 50/60 Hz	RB100: 4.7 VA max. (at 24 V AC) RB400/500/700: 5.8 VA max. (at 24 V AC) RB900: 6.0 VA max. (at 24 V AC)
3	21.6 to 26.4 V DC (Power supply voltage range), [Rating 24 V DC]	RB100: 108 mA max. (at 24 V DC) RB400/500: 141 mA max. (at 24 V DC) RB700/900: 147 mA max. (at 24 V DC)

- If there is electrical noise in the vicinity of the instrument that could affect operation, use a noise filter.
- Power supply wiring must be twisted and have a low voltage drop.
- This instrument is not provided with an overcurrent protection device. For safety install an overcurrent protection device (such as a fuse) with adequate breaking capacity close to the instrument.
 - Fuse type: Time-lag fuse (Approved fuse according IEC 60127-2 and/or UL 248-14)
 - Fuse rating: Rated current: 1 A
- For an instrument with 24 V power supply input, supply power from a “SELV” circuit defined as IEC 60950-1.
- A suitable power supply should be considered in end-use equipment. The power supply must be in compliance with a limited-energy circuits (maximum available current of 8 A).

■ **Output 1 (OUT1)/Output 2 (OUT2)**

- Terminal 5 and 6 are for output 1 (OUT1); Terminal 3 and 4 are for output 2 (OUT2).
- Connect an appropriate load according to the output type. (Specify when ordering)

	Heat control	Heat/Cool control		Wiring example
Relay contact output				
Voltage pulse output				
Voltage output/ Current output				
Triac output				
Open collector output				

- Outputs are isolated if output 1 (OUT1) or output 2 (OUT2) is “relay contact output” or “triac trigger output.” If both outputs are “relay contact output” or “triac trigger output,” outputs are not isolated.
- It is possible to specify the following uses for output when ordering. (Changes are not possible after the order has been placed.)

OUTPUT 1 (OUT1)	OUTPUT 2 (OUT2):
<ul style="list-style-type: none"> – PID control: OUT1 is dedicated to control output – Heat/Cool PID control: OUT1 can be used only as the heat-side output 	<ul style="list-style-type: none"> – PID control: OUT2 can be used as the transmission output * – Heat/Cool PID control: OUT2 corresponds to the cool-side output – Specify when Event 3 output (Only RB100) * <p>* Specify when ordering</p>

Continued on the next page.

Continued from the previous page.

- Number of outputs and output types must be specified when ordering. The specifications of each output are as follows.

Output 1 (OUT1) [PID control: Control output, Heat/Cool PID control: Heat output]

Output 2 (OUT2) [Heat/Cool PID control: Cool output]

Specification code		Output type	Specifications
OUT1	OUT2		
	N		No OUT2 output
M	M	Relay contact output (1)	250 V AC, 3A (Resistive load)/30 V DC, 1 A (Resistive load), 1a contact Electrical life: 100,000 times or more (Rated load)
V	V	Voltage pulse output	0/12 V DC (Allowable load resistance: 600 Ω or more)
4	4	Voltage output	0 to 5 V DC (Allowable load resistance: 1 kΩ or more)
5	5		0 to 10 V DC (Allowable load resistance: 1 kΩ or more)
6	6		1 to 5 V DC (Allowable load resistance: 1 kΩ or more)
7	7	Current output	0 to 20 mA DC (Allowable load resistance: 500 Ω or less)
8	8		4 to 20 mA DC (Allowable load resistance: 500 Ω or less)
T	T	Triac output	AC output (Allowable load current: 0.5 A [Ambient temperature 40 °C or less]), Load voltage: 75 to 250 V AC, Minimum load current: 30 mA, ON voltage: 1.6 V or less (at maximum load current)
D	D	Open collector output	Sink type (Allowable load current: 100 mA), Load voltage: 30 V DC or less, Minimum load current: 0.5 mA, ON voltage: 2 V or less (at maximum load current), Leakage current at OFF: 0.1 mA or less

Output 2 (OUT2) [Event 3 output (Only RB100)]*

Specification code	Output type	Specifications
P	Relay contact output (1)	250 V AC 3 A (Resistive load), 30 V DC 1 A (Resistive load), 1a contact Electrical life: 100,000 times or more (Rated load)

* For RB100, Output 2 (OUT2) can be specified as event output 3, when Control Method is “F”(reverse action) or “D”(direct action) and two digital outputs (DO1 and DO2) are specified.



For details on the specification code of the transmission output, refer to ■ **Transmission output (AO) [optional]**.

■ Transmission output (AO) [optional]

- Transmission output can be specified as output 2 (OUT2), when Control Method is specified to “F”(reverse action) or “D”(direct action).

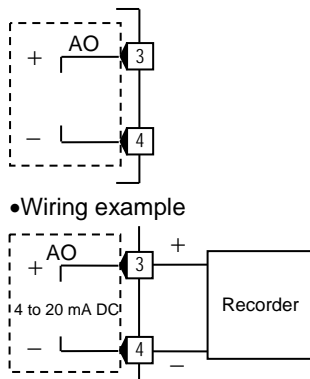

Output 2 (OUT2) [Transmission output]

Specification code	Output type	Specifications
X	Voltage output	0 to 5 V DC (Load resistance: 1 kΩ or more)
Y		0 to 10 V DC (Load resistance: 1 kΩ or more)
Z		1 to 5 V DC (Load resistance: 1 kΩ or more)
R	Current output	0 to 20 mA DC (Load resistance: 500 Ω or less)
S		4 to 20 mA DC (Load resistance: 500 Ω or less)

■ Digital output 1 to 4 (DO1 to DO4) [optional]

- Models that were specified with digital output when ordering can use the following terminal numbers.

RB100: Terminal No. 7 to 9 (DO1, DO2)

RB700: Terminal No. 10 to 12 (DO1, DO2), Terminal No. 7 to 9 (DO3, DO4)

RB400/500/900: Terminal No. 7 to 9 (DO1, DO2), Terminal No. 19 to 21 (DO3, DO4)

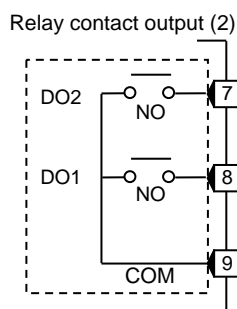

RB100/400/500/900

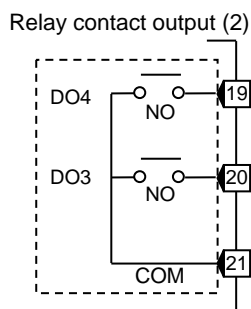

RB400/500/900

• Wiring example

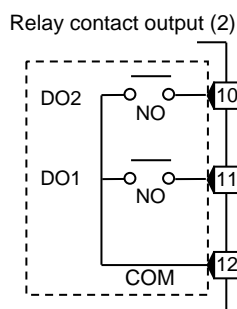
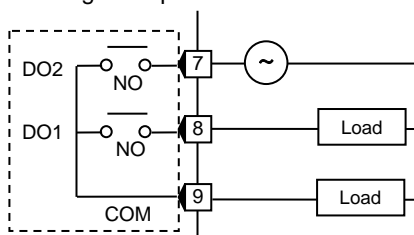

RB700

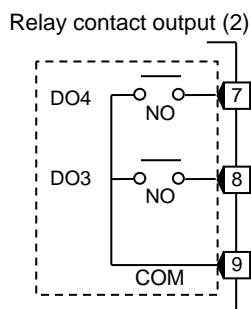

RB700

• Wiring example

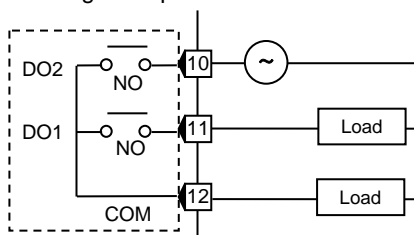

- Output type is only relay contact output (2).

Relay contact output (2)	250 V AC 1A (Resistive load), 30 V DC 0.5 A (Resistive load), 1a contact Electrical life: 150,000 times or more (Rated load)
--------------------------	---

- Output of the Event function can be allocated to DO1 to DO4.
- Outputs of DO1/DO2 and DO3/DO4 are isolated.
DO1 and DO2 or DO3 and DO4 use the same common terminal (RB100/400/500/900: No. 9 for DO1/DO2, and No. 21 for DO3/DO4 RB700: No. 12 for DO1/DO2, and No. 9 for DO3/DO4) and are not isolated.
- For RB400/500/700/900, the maximum number of digital outputs (DO) depends on output types of OUT1 and OUT2. Refer to the “table of the maximum number of DO below.

M: Relay contact output (1) V: Voltage pulse output T: Triac output D: Open collector output

		OUT2 (Including transmission output)					
		No OUT2 output	M, T, D	V (Load: 10 mA)	V (Load: 20 mA)	Current output	Voltage output
OUT1 *	M, T, D	DO: 4 points	DO: 4 points	DO: 4 points	DO: 4 points	DO: 4 points	DO: 4 points
	V (Load: 10 mA)	DO: 4 points	DO: 4 points	DO: 4 points	DO: 4 points	DO: 2 points	DO: 2 points
	V (Load: 20 mA)	DO: 4 points	DO: 4 points	DO: 4 points	DO: 2 points	DO: 2 points	DO: 2 points
	Current output	DO: 4 points	DO: 4 points	DO: 2 points	DO: 2 points	DO: 2 points	DO: 2 points
	Voltage output	DO: 4 points	DO: 4 points	DO: 2 points	DO: 2 points	DO: 2 points	DO: 2 points

(): It represents selection of digital outputs DO3 and DO4 is not available.)

* When the instrument has two digital outputs (DO1 and DO2) and no OUT2 output, “V” type output (load: 40 mA) can be specified for OUT1.

■ Measured input (Thermocouple/RTD/Voltage/Current) [universal input]

- For the measured input type, terminals 10 through 12 (RB700: terminals 16 through 18) are allocated to the measured input.

RB100/400/500/900:

Thermocouple input

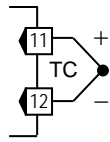

RTD input

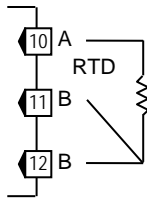

Voltage input

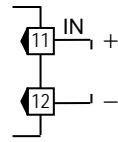

Current input *

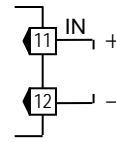

* Shunt resistor KD100-55 (sold separately) must be mounted between input terminals

RB700:

Thermocouple input

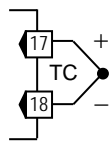

RTD input

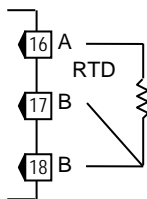

Voltage input

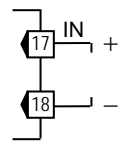

Current input *

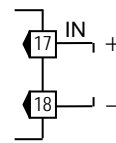

* Shunt resistor KD100-55 (sold separately) must be mounted between input terminals

- The input types (input group) are as follows.

Input group		Input type
Temperature input group	Thermocouple	K, J, T, S, R, E, B, N (JIS C1602-1995), PLII (NBS), W5Re/W26Re (ASTM-E988-96)
	RTD	Pt100 (JIS C1604-1997), JPt100 (JIS C1604-1997, JIS C1604-1981 of Pt100)
Voltage/current input group	Voltage (low)	0 to 1 V DC, 0 to 5 V DC, 1 to 5 V DC, 0 to 10 V DC
	Current	0 to 20 mA DC, 4 to 20 mA DC

- For thermocouple input, use the appropriate compensation wire.
- For RTD input, use low resistance lead wires with no difference in resistance between the three lead wires.
- Signal connected to Voltage input and Current input shall be low voltage defined as “SELV” circuit per IEC 60950-1.
- To avoid noise induction, keep input signal wire away from instrument power line, load lines and power lines of other electric equipment.
- For the current input specification, a shunt resistor of $250 \Omega \pm 0.02 \%$ (Temperature characteristics: $\pm 10 \text{ ppm}/^\circ\text{C}$, Specified voltage: 0.25 W or more) must be connected between the input terminals.
Shunt resistor: Model code: KD100-55 (sold separately)

■ Digital input (DI1, DI2) [optional]

- Models that were specified with digital input when ordering can use the following terminal numbers.

RB100: Terminal No. 13 to 15 (DI1, DI2)

RB700: Terminal No. 22 to 24 (DI1, DI2)

RB400/500/900: Terminal No. 16 to 18 (DI1, DI2)

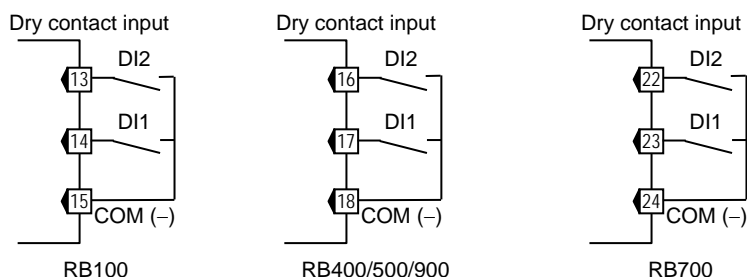

- Digital input from external devices or equipment should be dry contact input. If it is not dry contact input, the input should meet the specifications below.

Contact specifications: At OFF (contact open): 500 k Ω or more

At ON (contact closed) 10 Ω or less

- The following functions can be assigned to digital inputs. (Can be specified when ordering.)

SV selection, RUN/STOP transfer, Interlock release, Auto (AUTO)/Manual (MAN) transfer

To assign functions to digital inputs, refer to **8.5 Engineering Mode (P. 8-95)**.

■ Current transformer (CT) input [optional]

- Models that were specified with a current transformer (CT) when ordering can use the following terminal numbers. When a current transformer (CT) input is specified, a digital output must also be specified.

RB100: Terminal No. 16 to 18 (CT1, CT2)

RB700: Terminal No. 13 to 15 (CT1, CT2)

RB400/500/900: Terminal No. 22 to 24 (CT1, CT2)

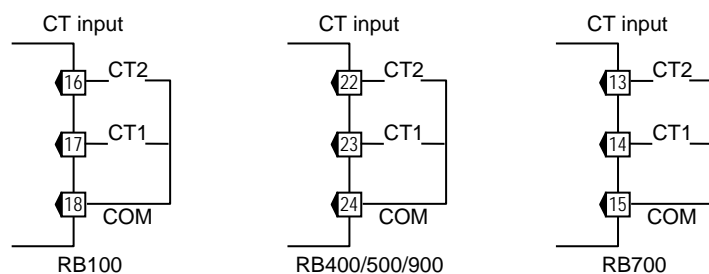

- When using CT input, connect CTs to the relevant terminals.

Current transformer model code:

CTL-6-P-N [Measurement current range: 0 to 30 A] (sold separately)

CTL-12-S56-10L-N [Measurement current range: 0 to 100 A] (sold separately)

- Current transformer (CT) input is not isolated between measured input.

■ Communication [optional]

- With Communication function, terminals 13 through 15 (RB700: terminals 25 through 27) are allocated to Communication.

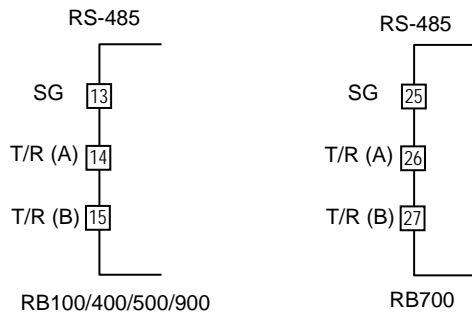

-  For the wiring, refer to **Communication Quick Instruction Manual (IMR02C41-E□)** or **Communication Instruction Manual (IMR02C16-E□)**.

3.4 Handling of the Terminal Cover [optional]

When mounting and removing the terminal cover, take the following steps:



WARNING

To prevent electric shock or instrument failure, always turn off the power before mounting or removing the terminal cover.



When mounting and removing the terminal cover, apply pressure very carefully to avoid damage to the terminal cover.

■ Mounting procedures

1. Check the mounting direction of the terminal cover.
2. Push the protrusions of terminal cover into the insertion slots for mounting the terminal cover.

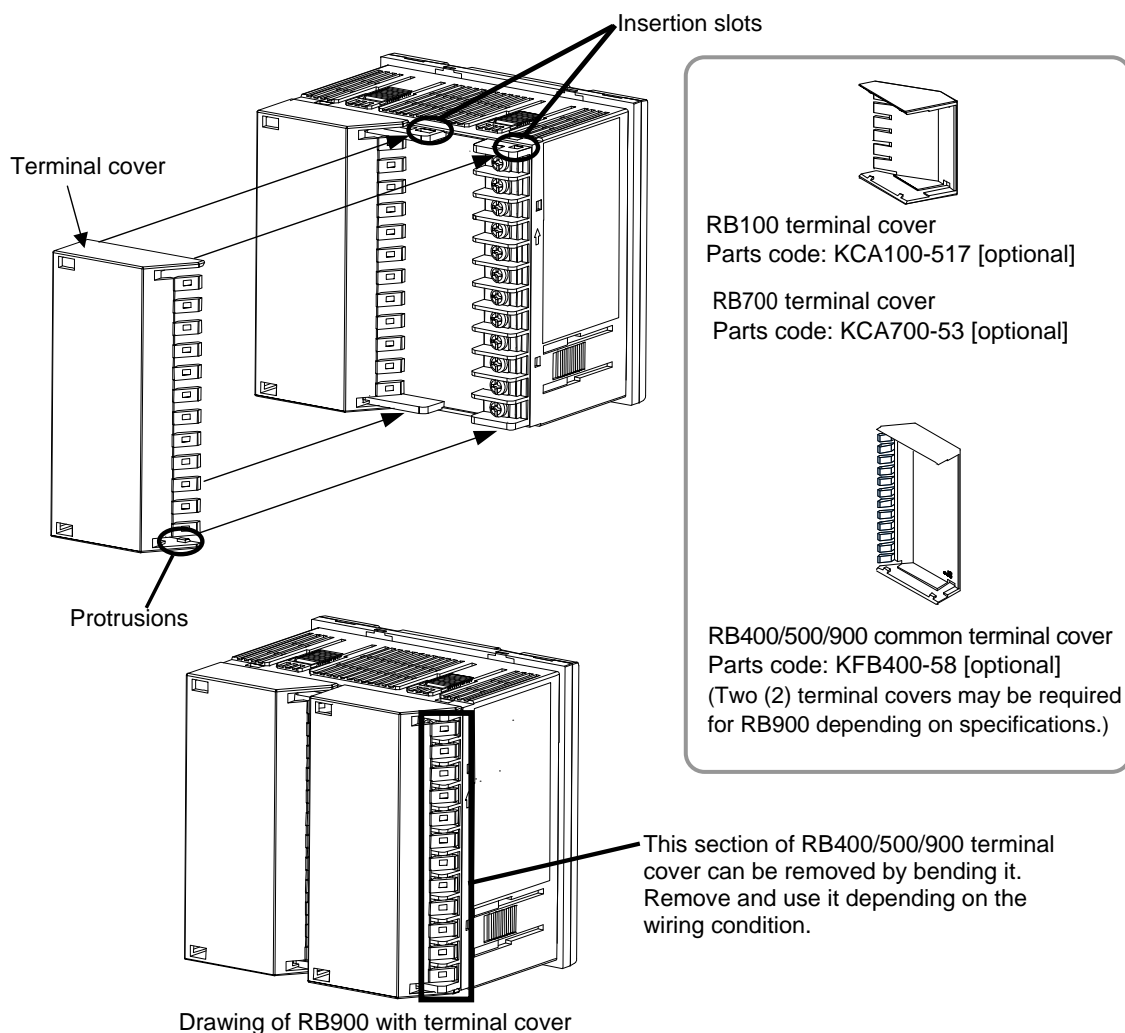

RB900 is used in the explanatory drawing. The above mounting procedures in the example shown are the same for RB100, RB400, RB500 and RB700.

Drawing of RB400 with terminal cover

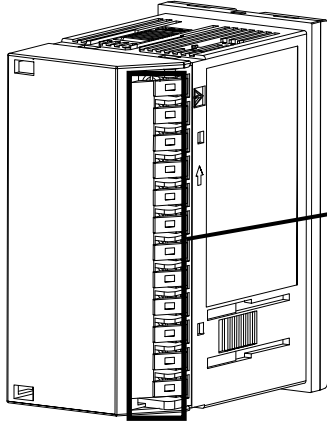

Drawing of RB100 with terminal cover

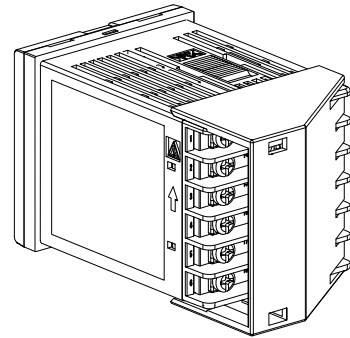

This section of RB400/500/900 terminal cover can be removed by bending it. Remove and use it depending on the wiring condition.

■ Removal procedures

Release the protrusions of terminal cover from the insertion slots (①) shown in the following figure, and then pull the terminal cover (②) to remove it from the case.

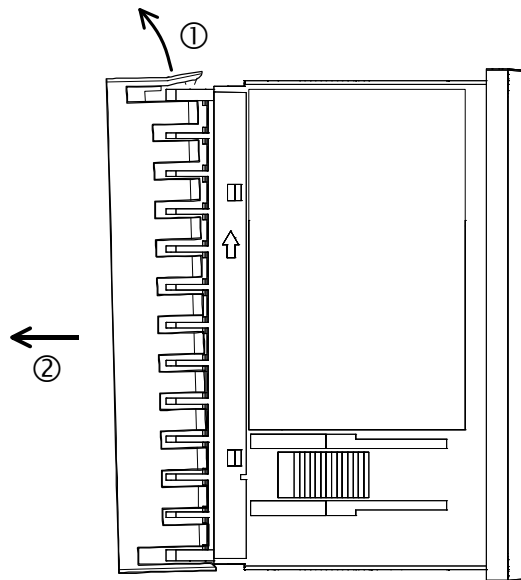

BASIC OPERATION



This chapter explains the basic operations of switching modes and changing set values.

4.1 Operation Menu	4-2
4.2 Changing Set Value	4-4

4.1 Operation Menu

The controller has five different modes. All settable parameters belong to one of them. The following chart show how to access different setting mode.

For the details of changing set value, refer to **4.2 Changing Set Value (P. 4-4)**.

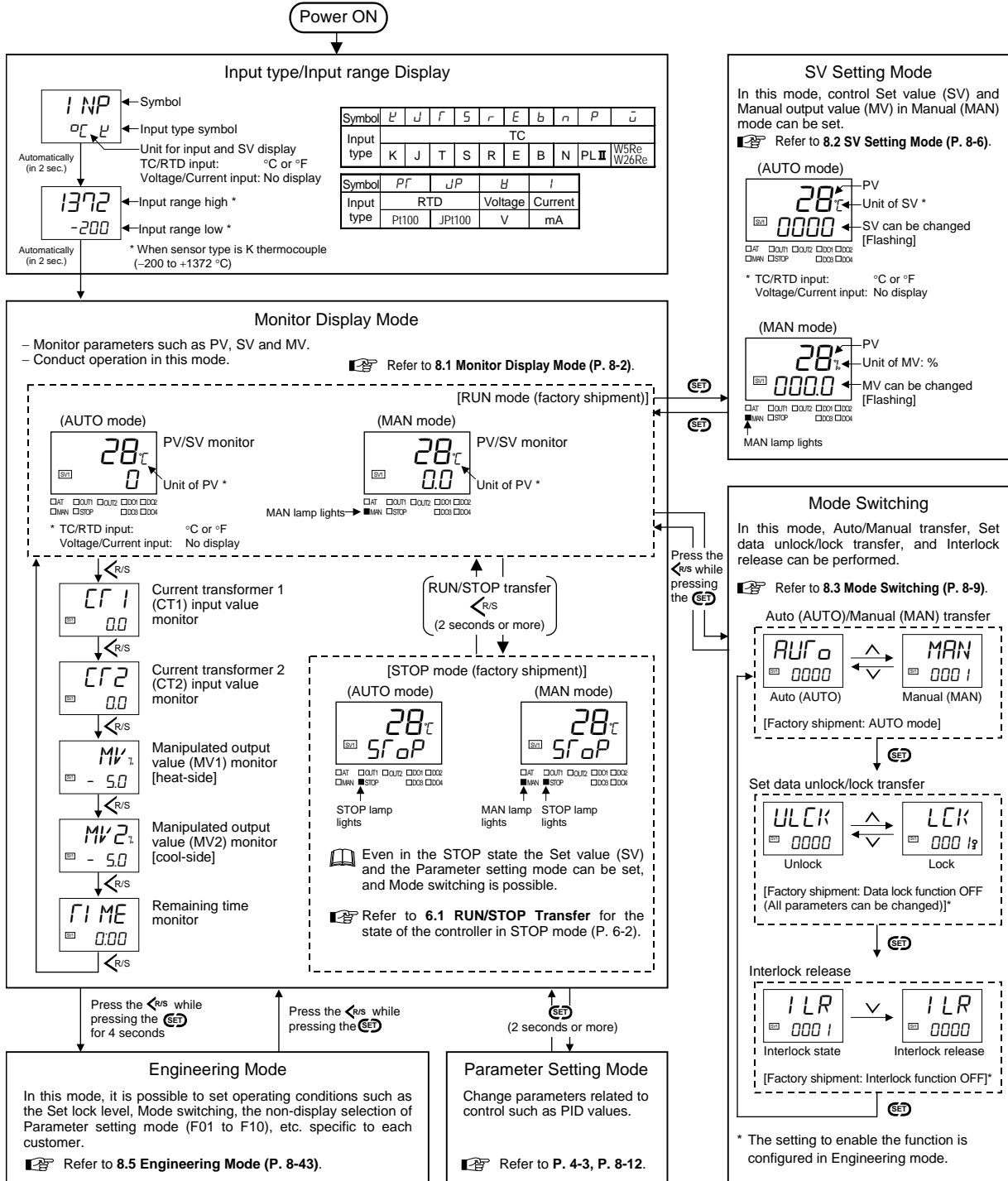

- Display returns to the PV/SV monitor if no key operation is performed within 1 minute.
- If any item not described in the specification or the relevant function is not selected, there may be parameters which are not displayed.

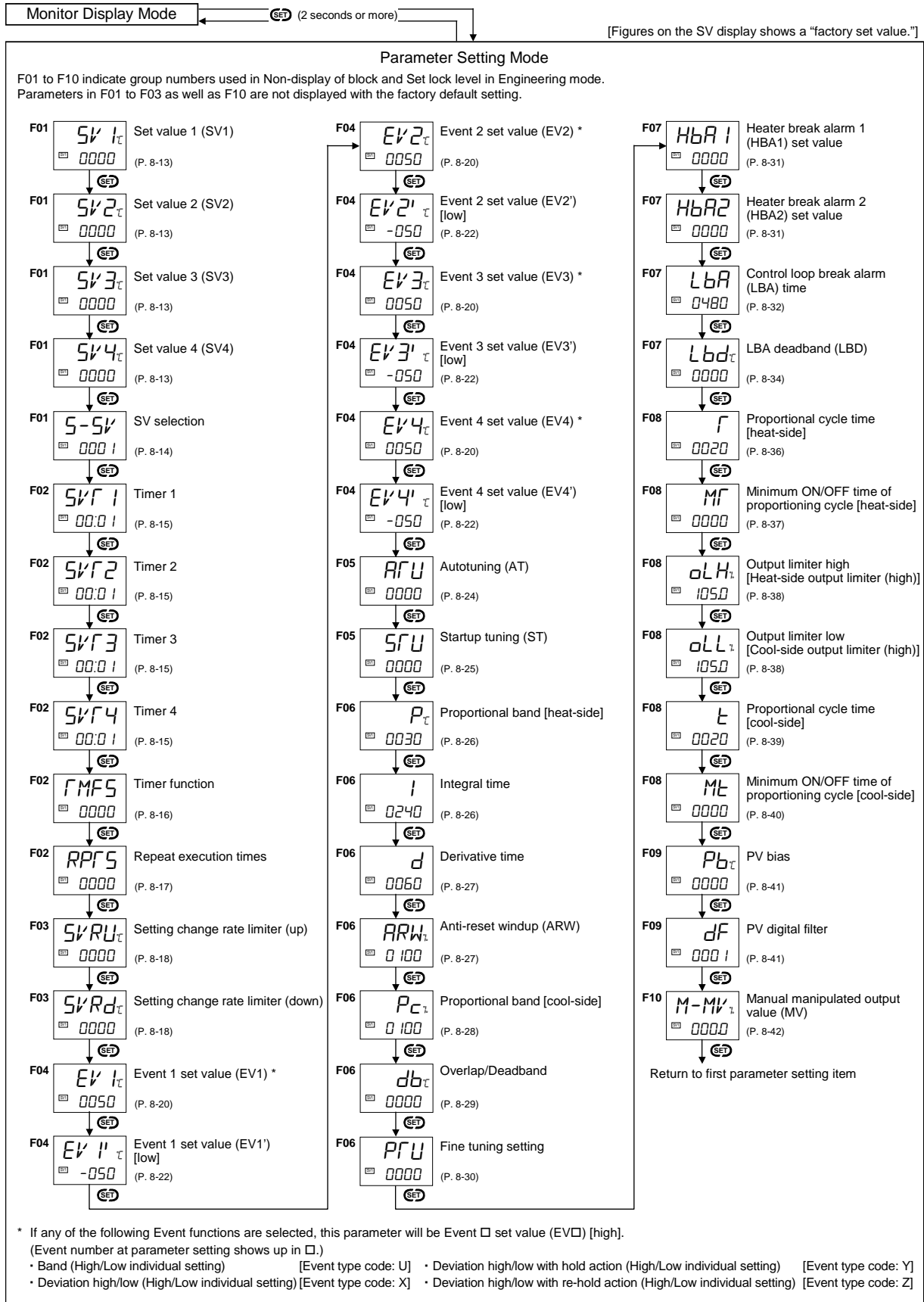

4.2 Changing Set Value

- The flashing digit indicates which digit can be set. Press \leftarrow $\overline{R/S}$ key to go to a different digit. Every time the shift key is pressed, the flashing digit moves as follows.

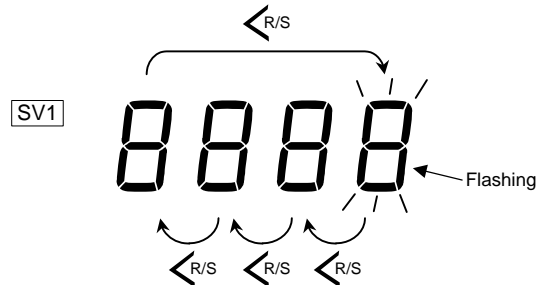

- The following is also available when changing the set value.

Increase SV from 199 °C to 200 °C:

- Press the \leftarrow $\overline{R/S}$ key to flash the ones place (first digit from the right).
- Press the \wedge key to change to 0.
The display changes to 200.

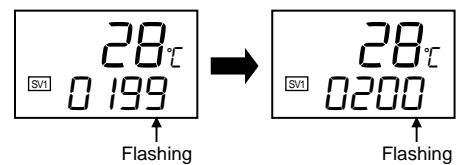

Decrease SV from 200 °C to 190 °C:

- Press the \leftarrow $\overline{R/S}$ key to flash the tens place.
- Press the \vee key to change to 9.
The display changes to 190.

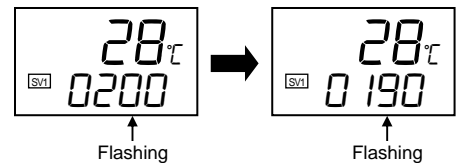

Decrease SV from 200 °C to -100 °C:

- Press the \leftarrow $\overline{R/S}$ key to flash the hundreds place.
- Press the \vee key (three times) to change to -1.
The display changes to -100.

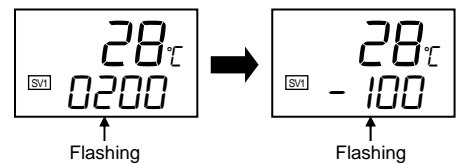

- To store a new value for the parameter, always press the SET key.** The display changes to the next parameter and the new value will be stored.



A new value will not be stored without pressing SET key after the new value is displayed on the display.



After a new value has been displayed by using the \wedge and \vee keys, the SET key must be pressed within 1 minute, or the new value is not stored and the display will return to the Monitor display mode.

SETUP PROCEDURES PRIOR TO RUNNING THE INSTRUMENT



This chapter explains basic setup procedures prior to running the instrument.

5.1 Initial Setting.....	5-3
■ Check the parameter related to the input	5-3
■ Check the parameter related to the event	5-4
■ Check the parameter related to the control action.....	5-5
5.2 Operation Setting	5-6
■ Set the control set value	5-6
■ Set the event set value	5-7
5.3 Operation Start.....	5-8
■ Change from STOP to RUN	5-9
■ Tunes up PID parameters	5-10

Setup the controller prior to operating the instrument. Refer to the following setup example.

Setup example:
 Input specification: Thermocouple (K) 0 to 400 °C
 Control action: PID action with AT (Reverse action)
 Event specification (Event 1): Deviation high/low with hold action (Uses Interlock function)
 Control set value: 200 °C
 Event set value: 20 °C
 PID parameters: Automatic setting by Autotuning (AT)

■ **Operation procedure**

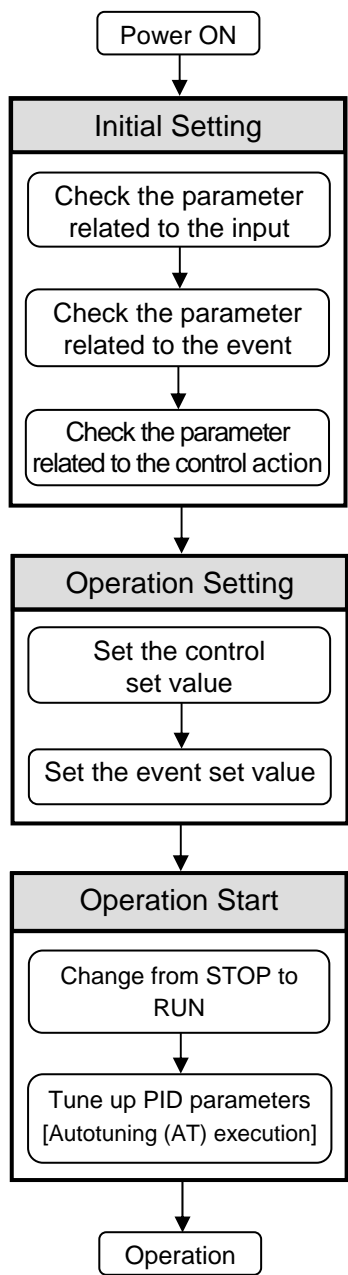

☞ For operating of initial setting (Engineering mode), refer to **5.1 Initial Setting (P. 5-3)**.

⚠ WARNING

Parameters in the Engineering mode should be set according to the application before setting any parameter related to operation. Once the parameters in the Engineering mode are set correctly, no further changes need to be made to parameters for the same application under normal conditions. If they are changed unnecessarily, it may result in malfunction or failure of the instrument. RKC will not bear any responsibility for malfunction or failure as a result of improper changes in the Engineering mode.

☞ For operation setting, refer to **5.2 Operation Setting (P. 5-6)**.

☞ For operation start, refer to **5.3 Operation Start (P. 5-8)**.

5.1 Initial Setting

■ Check the parameter related to the input

Parameter settings related to the control input specifications such as the input type, can be checked in Engineering mode. Parameters which are not specified when ordering must be set before use.

Setup example:

Input specification: Thermocouple (K) 0 to 400 °C [Input range code: K02]

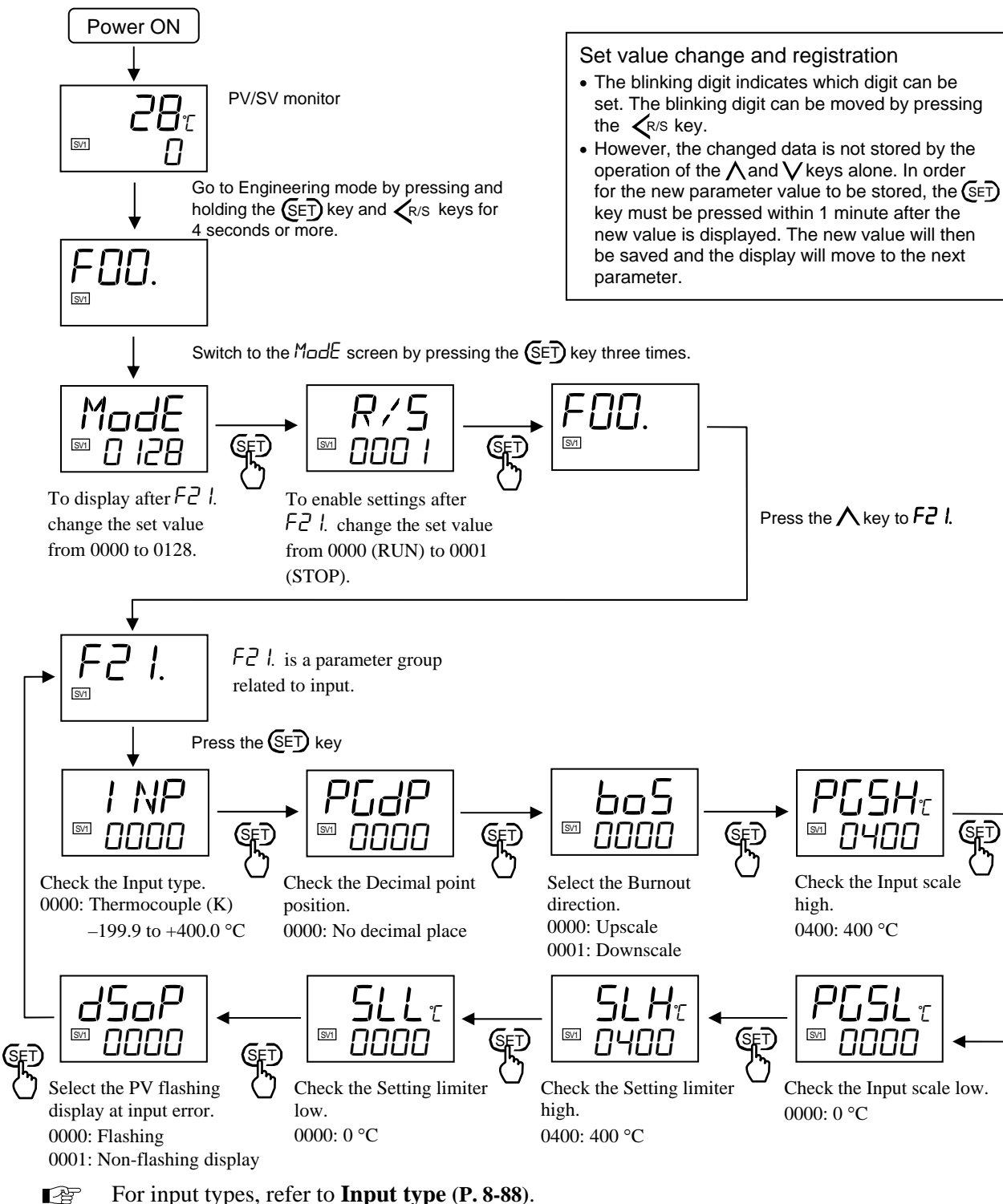

■ Check the parameter related to the event

Parameter settings related to event action can be checked in Engineering mode. Parameters which are not specified when ordering must be set before use.

Setup example:

Event specification (Event 1):
 Deviation high/low with hold action [Quick start code: G]
 Uses Interlock function

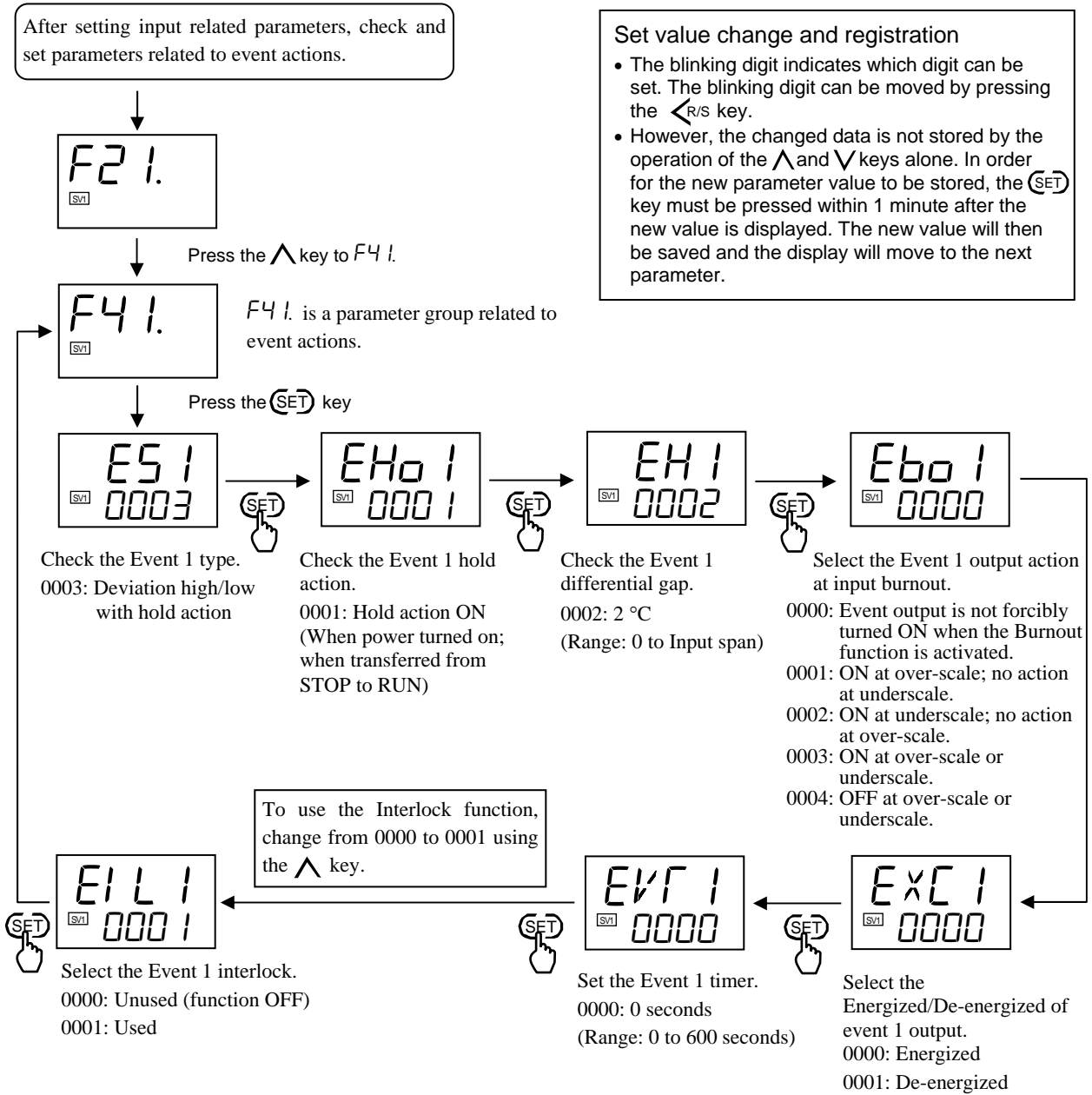

☞ For Event 1 parameter, refer to **Function block 41 (F41) (P. 8-101 to 8-121)**.

■ Check the parameter related to the control action

Parameter settings related to control action can be checked in Engineering mode. Parameters which are not specified when ordering must be set before use.

Setup example:

Control action: PID action with AT (Reverse action) [Suffix code: F]

After setting event action related parameters, check and set parameters related to control actions.

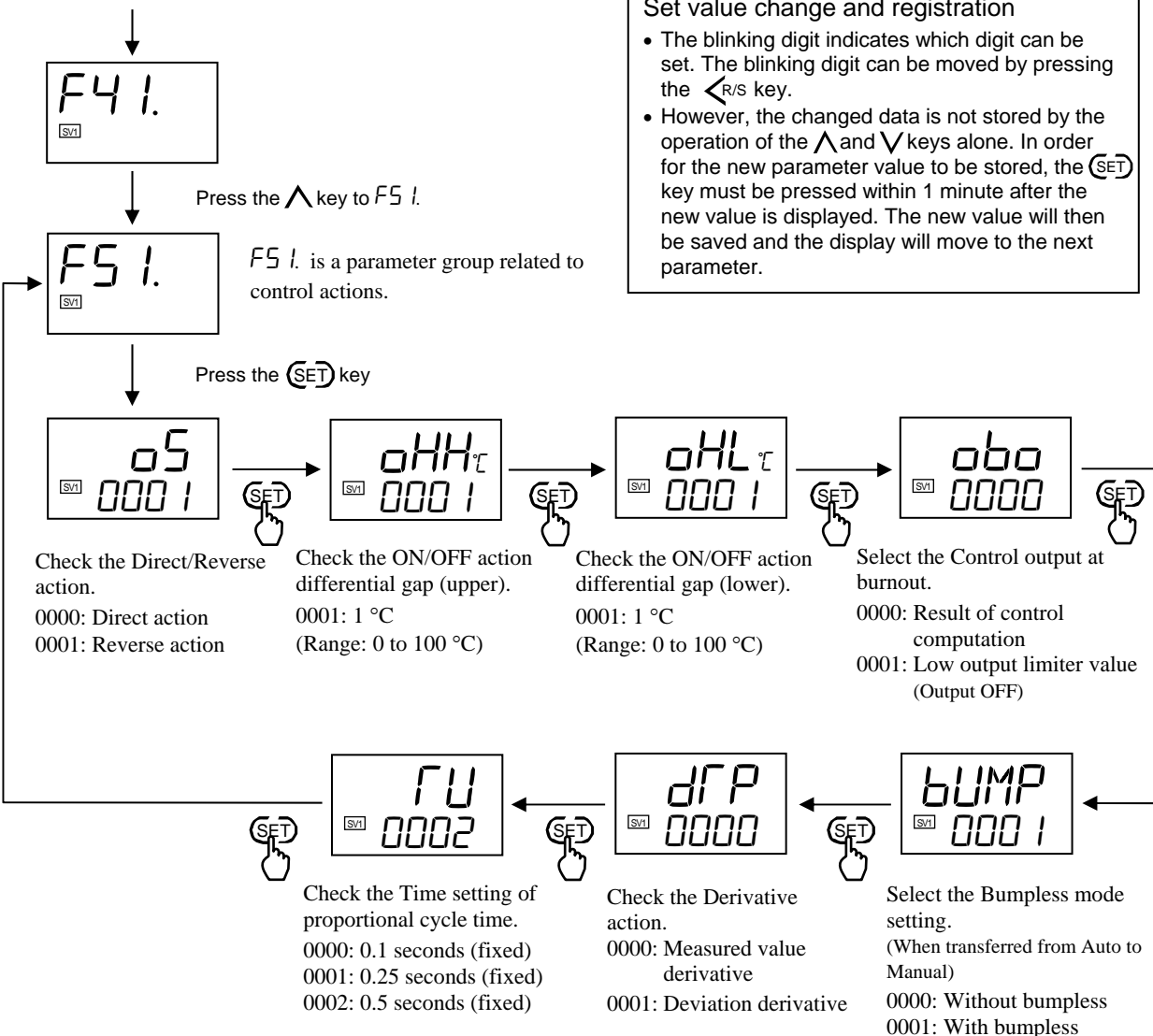

☞ For control action parameter, refer to **Function block 51 (F51) (P. 8-124 to 8-129)**.

To hide Engineering mode screens:

After setting parameters in Engineering mode from Function block 21 (*F2 I.*) to 51 (*F5 I.*) must be hidden to prevent accidental parameter change from the front keys. To hide the Engineering mode screens from *F2 I.* to *F5 I.*, go to the *ModE* screen of *F00.* and change from "0128" to "0000."

5.2 Operation Setting

■ Set the control set value

After finishing the initial settings, set the control target value, SV.

[Setting example: Set the control set value 1 (SV1) to 200 °C.]

1. Make sure that the PV/SV monitor screen is displayed, and SV1 is selected (factory set value: SV1), then press the **(SET)** key to go to the SV setting mode.

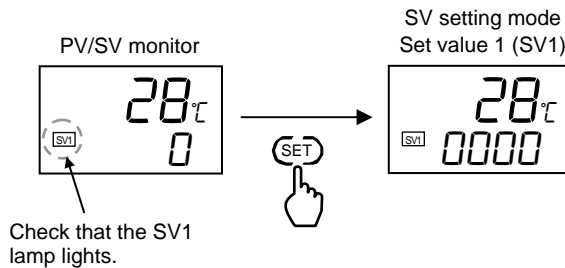

2. Change SV1 to 200 °C using the **<R/S**, and **^** keys, then press the **(SET)** key to store the new set value.

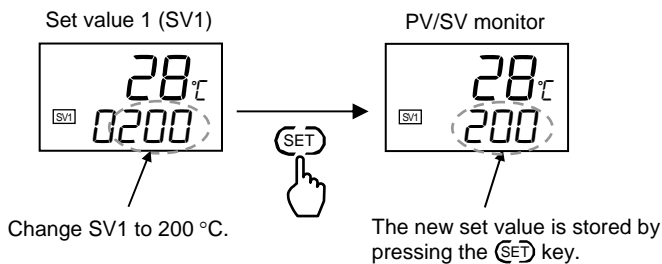

Setting range:

Setting limiter low to Setting limiter high

[Factory set value: 0 (0.0)]

Set value change and registration

- The blinking digit indicates which digit can be set. The blinking digit can be moved by pressing the **<R/S** key.
- However, the changed data is not stored by the operation of the **^** and **v** keys alone. In order for the new parameter value to be stored, the **(SET)** key must be pressed within 1 minute after the new value is displayed. The new value will then be saved and the display will move to the next parameter.



To set SV2, SV3 and SV4, or to set SVs using digital input, refer to **7.1 SV Selection Function (Step SV function) (P. 7-2)**.

■ **Set the event set value**

After finishing the initial settings, set the event set values if they are used.

[Setting example: Set the Event 1 set value (EV1) to 20 °C]

1. Press and hold the **(SET)** key for 2 seconds or more at the PV/SV monitor screen until the Parameter setting mode screen is displayed. Then, press the **(SET)** key to go to the EV1 screen.

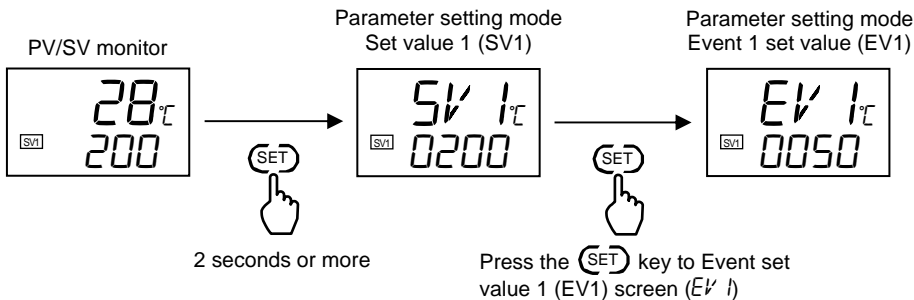

📖 When “0: No event” is selected for the Event type in Engineering mode, the Event setting screen is not displayed.

2. Change EV1 to 20 °C using the **←R/S**, and **∇** keys, then press the **(SET)** key to store the new set value.

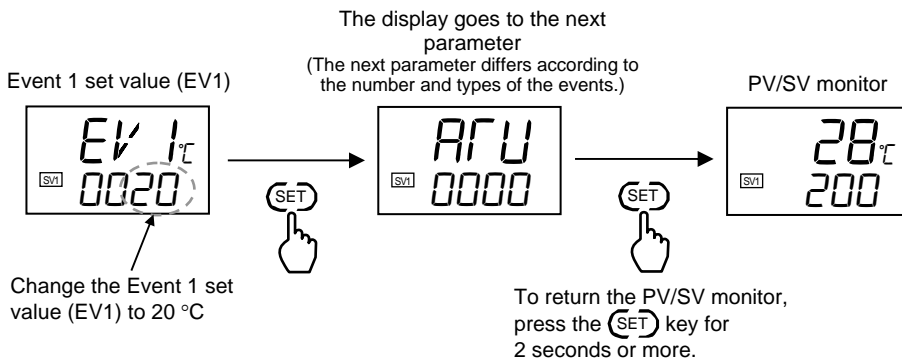

Setting range:
 Deviation action: -Input span to +Input span
 Input value or set value action: Same as input range
 [Factory set value: TC/RTD: 50 (50.0), V/I: 5.0]

Set value change and registration

- The blinking digit indicates which digit can be set. The blinking digit can be moved by pressing the **←R/S** key.
- However, the changed data is not stored by the operation of the **∧** and **∇** keys alone. In order for the new parameter value to be stored, the **(SET)** key must be pressed within 1 minute after the new value is displayed. The new value will then be saved and the display will move to the next parameter.

📖 For details on other parameters related to Event functions, refer to ■ **Check the parameter related to the event (P. 5-4).**

5.3 Operation Start

Check the following precautions before starting operation.

CAUTION

■ Power ON

There is no power switch on this instrument, so the instrument starts operation immediately following initial power ON. **[Factory set value: RUN (Control start)]**

■ Action at input error

If the input signal wiring is disconnected or short-circuited (RTD input only), the instrument determines that burnout has occurred.

• Burnout direction

Thermocouple input:

According to the setting contents of Burnout direction in the Engineering mode.

0: Upscale 1: Downscale

[Factory set value: Upscale]

RTD input: Upscale (at input break) or downscale (at short-circuited)

Voltage/Current input:

Downscale or indicate the value near 0

• Output at burnout

Control output: According to the setting contents of Control output at burnout in the Engineering mode.

0: Result of control computation 1: Low output limiter value (Output OFF)

[Factory set value: Result of control computation]

Event output: According to the setting contents of Event output action at input burnout in the Engineering mode.

0: Event output is not forcibly turned on when the Burnout function is activated.

1: ON at over-scale; no action at underscale.

2: ON at underscale; no action at over-scale.

3: ON at over-scale or underscale.

4: OFF at over-scale or underscale.

[Factory set value: Event output is not forcibly turned on when the Burnout function is activated.]

■ Check each parameter

The settings for the SV and all parameters should be appropriate for the controlled system.

There are parameters in Engineering mode which can not be changed when the controller is in RUN mode. Change the RUN/STOP mode from RUN to STOP when a change to parameters in Engineering mode is necessary.

■ Event hold action

• The event hold action is activated when the power is turned on or when transferred from STOP mode to RUN mode. (Event type with hold action)

• The event re-hold action is activated when not only the SV is changed, but also when power is turned on or when transferred from STOP mode to RUN mode. (Event type with re-hold action)

■ Action at power failure

A power failure of 20 ms* or less will not affect the control action. When a power failure of more than 20 ms* occurs the instrument assumes that the power has been turned off.

* 10ms for RB100 with 24V AC/DC power supply

■ Action at power fail recovery

The instrument will return to the same RUN/STOP state and the same operation mode which were used by the instrument before power failure.

• In case of AUTO mode

Output changes from the Output limiter low with control calculation results.

• In case of Manual (MAN) mode

Output status is defined as follows by the Bumpless mode setting in the Engineering mode.

In case of "0: Without bumpless"	In case of "1: With bumpless" (Factory set value)
Preset manual value is output.	PID control: Output limiter low is output Heat/Cool PID control: Output is 0 %

Change from STOP to RUN

To start control, change the RUN/STOP mode from STOP (stop control) to RUN (start control).

Press and hold the \leftarrow R/S key for 2 seconds or more at the PV/SV monitor screen and the instrument will switch from STOP to RUN.

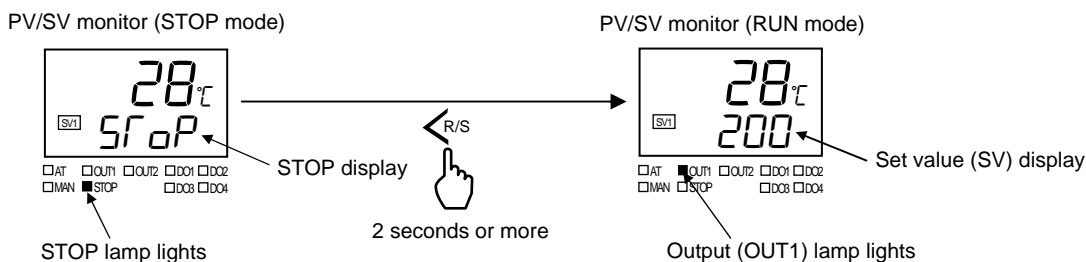

To change from RUN mode to STOP mode, press and hold the \leftarrow R/S key for 2 seconds or more.

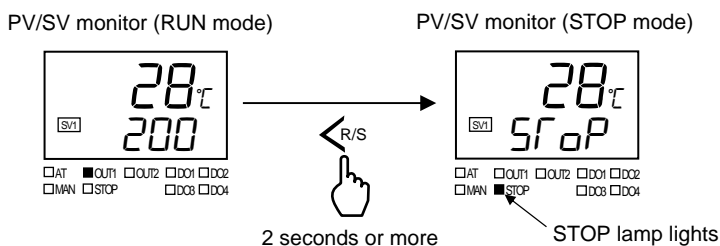

State of this instrument when set to STOP mode

STOP display	According to the setting contents of STOP display selection in the Engineering mode. (Factory set value: StoP on SV display + STOP lamp lights)
Control output	Output is -5.0 %
Event output	According to the setting contents of Output action at STOP mode in the Engineering mode.
Transmission output (AO)	[Factory set value: Both Event output and Transmission output (AO) is OFF]

- The RUN/STOP transfer can be made by digital input (DI) [optional] or communication [optional] other than the key operation.
- For details of the RUN/STOP transfer by digital input (DI), refer to the **6.1 RUN/STOP Transfer (P. 6-6)**.
- For details of the RUN/STOP transfer by communication, refer to the **Communication Instruction Manual (IMR02C16-E□)**.

■ **Tuning PID parameters**

Suitable PID values are automatically calculated by Autotuning (AT) function.

The Autotuning (AT) function automatically measures, computes and sets the optimum PID values.

 Before start autotuning, make sure that all required conditions (refer to P. 6-8) to start AT are satisfied.

● **Start the Autotuning (AT)**

1. Press and hold the (SET) key for 2 seconds or more at the PV/SV monitor screen to go to the Parameter setting mode, and press the (SET) key to display the AT screen.

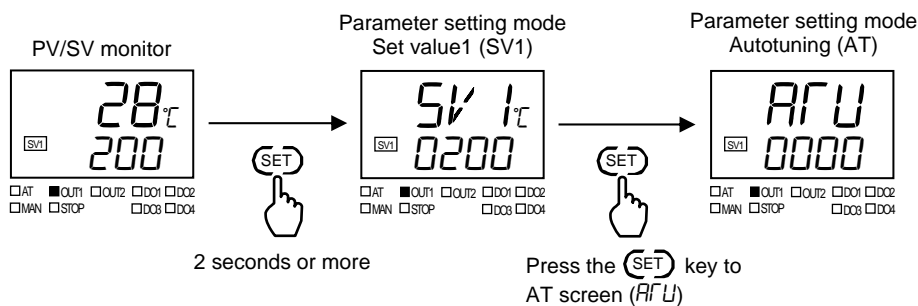

2. Press the ^ key to change the blinking digit from 0 to 1. Press the (SET) key and autotuning will start. The AT lamp on the front panel will flash.

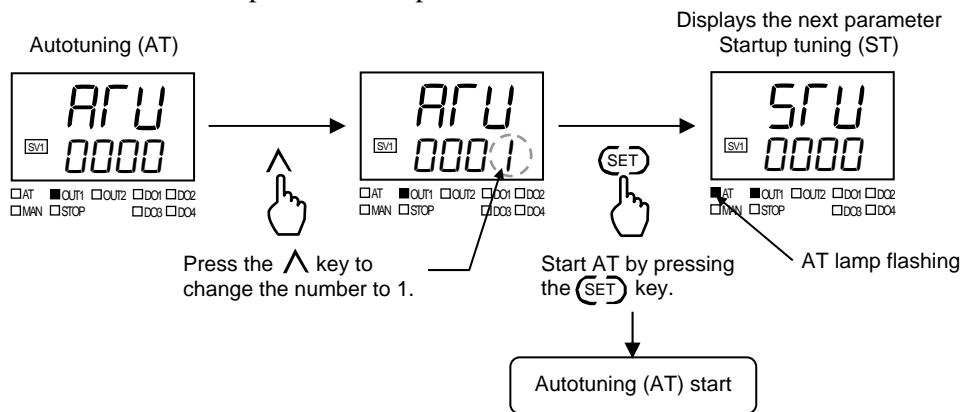

● **Autotuning (AT) finish**

When the Autotuning (AT) is finished, the control will automatically returns to PID control and the AT lamp turns off.

● **Autotuning (AT) cancellation**

When canceling the Autotuning function (AT), press the V key to be set to “0000” with the Autotuning (AT) screen.

● **Return to the PV/SV monitor**

To return the PV/SV monitor, press and hold the (SET) key for 2 seconds or more.

 After a new value is displayed on the display by using ^ and V keys, if no key operation is performed within 1 minute without pressing (SET) key, this instrument returns to the PV/SV monitor screen and the set value will not be changed.

● **To manually adjust the PID parameters**

If the Autotuning (AT) function does not match the controlled object requirements, the optimum PID values may not be calculated by Autotuning (AT). In that case, adjust the PID parameters manually.

● **Change the Proportional band (P)**

[Example: Change the Proportional band (P) to 20 °C]

1. Press and hold the (SET) key for 2 seconds or more at the PV/SV monitor screen to go to the Parameter setting mode, and press the (SET) key to display the Proportional band [heat-side] screen.

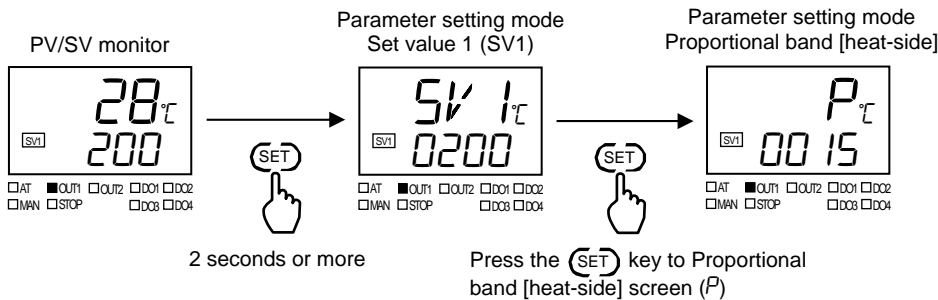

2. Press the <R/S, ^, and V keys to change from “0015” to “0020.” Press the (SET) key to store the new value.

Proportional band [heat-side]

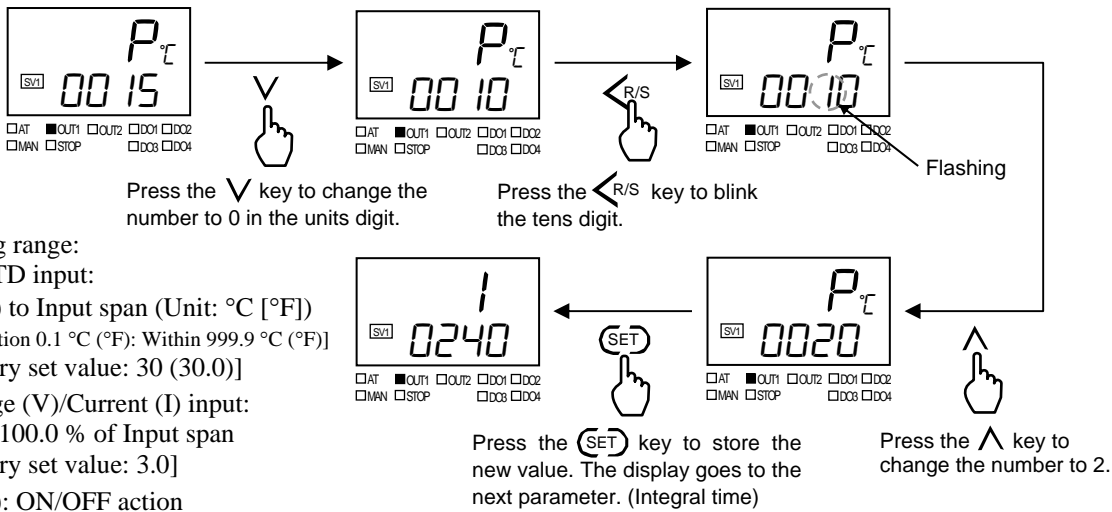

Setting range:
 TC/RTD input:
 1 (0.1) to Input span (Unit: °C [°F])
 [Resolution 0.1 °C (°F): Within 999.9 °C (°F)]
 [Factory set value: 30 (30.0)]
 Voltage (V)/Current (I) input:
 0.1 to 100.0 % of Input span
 [Factory set value: 3.0]
 0 (0.0): ON/OFF action

● **Change the Integral time (I) and Derivative time (D)**

The setting procedure applies when the Integral time and the Derivative time are also set.

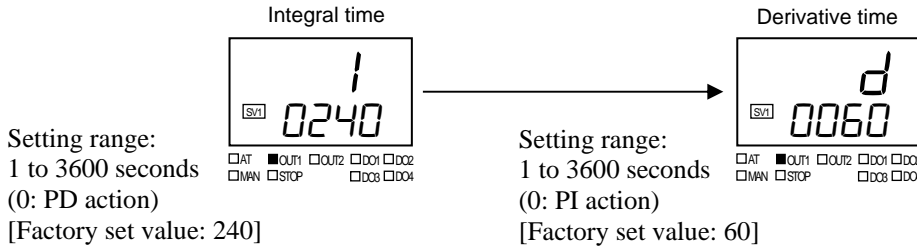

● **Return to the PV/SV monitor**

To return the PV/SV monitor, press and hold the (SET) key for 2 seconds or more.



After a new value is displayed on the display by using ^ and V keys, if no key operation is performed within 1 minute without pressing (SET) key, this instrument returns to the PV/SV monitor screen and the set value will not be changed.

● **Changing control response with Fine tuning**

After suitable PID values are calculated and stored by Autotuning or manual PID setting, the Fine tuning allows you to change the control response of the same PID constant control. The control response can be changed from fast to slow by simply changing the Fine tuning setting (6 levels: -3 to +3) in Parameter setting mode while the PID constant is unchanged.

 For details of the Fine tuning, refer to **6.4 Fine Tuning (P. 6-17)**.

● **Fine tuning setting**

[Example: To slow the response (when “-1” is set)]

1. Press and hold the (SET) key for 2 seconds or more at the PV/SV monitor screen to go to the Parameter setting mode, and press the (SET) key to display the Fine tuning setting screen.

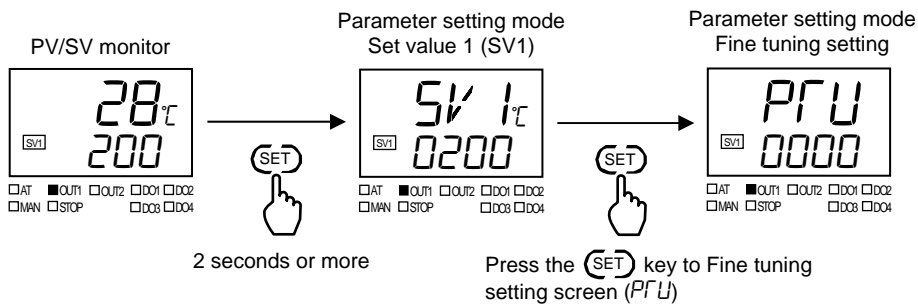

2. Next, press the √ key to change the number of the flashing digit. Press the (SET) key to store the new value.

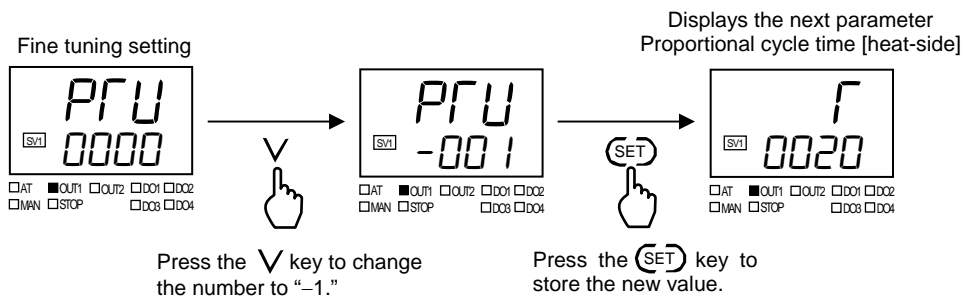



Fine tuning setting range:
-3 to +3

[Factory set value: 0 (Unused)]

When set to a positive value (+), the response becomes faster.

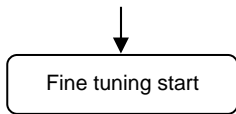
When set to a negative value (-), the response becomes slower.



 If the set value of Fine tuning is returned to “0: Unused,” Fine tuning correction will be turned off.

● **Return to the PV/SV monitor**

To return the PV/SV monitor, press and hold the (SET) key for 2 seconds or more.

 After a new value is displayed on the display by using ^ and v keys, if no key operation is performed within 1 minute without pressing (SET) key, this instrument returns to the PV/SV monitor screen and the set value will not be changed.

OPERATIONS OF THE BASIC FUNCTIONS

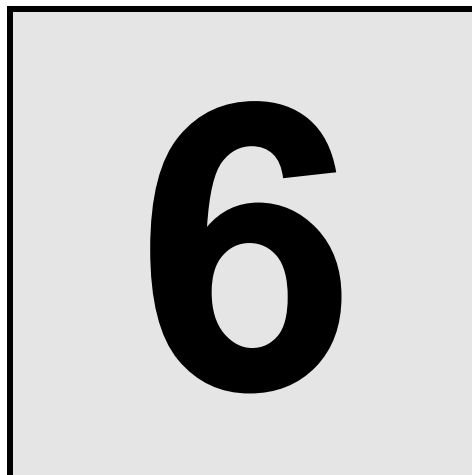

This chapter describes the basic functions and the procedures for using basic functions.

6.1 RUN/STOP Transfer.....	6-2
6.2 Autotuning (AT)	6-8
6.3 Startup Tuning (ST)	6-11
6.4 Fine Tuning.....	6-17
6.5 Auto/Manual Transfer	6-20
6.6 Protecting Setting Data (Data lock function)	6-24
6.7 Display/No display Setting of Mode Screens	6-32
6.8 Interlock Release	6-39

6.1 RUN/STOP Transfer

It is possible to transfer between control start (RUN) and control stop (STOP). RUN/STOP transfer can be performed by \leftarrow R/S key operation, by key operation using the RUN/STOP setting in Engineering mode, by digital input (DI) [optional] or communication [optional]. All methods of RUN/STOP operation are linked. For example, when the mode is changed from RUN to STOP via \leftarrow R/S key operation, the setting of RUN/STOP setting in Engineering mode will also change to “STOP.”



When the digital input RUN/STOP transfer function is used, it is impossible to transfer RUN/STOP through key operation if the contact is not closed. (When contact opens: STOP mode is maintained.)



For details of the RUN/STOP transfer by communication, refer to **Communication Quick Instruction Manual (IMR02C41-E□)** and **Communication Instruction Manual (IMR02C16-E□)**.

● State of this instrument when set to STOP mode

STOP display	<ul style="list-style-type: none"> • STOP lamp lights (Green) • Displays the STOP symbol “$Sf \square P$” on the SV or PV displays <p>The display content depends on the setting of STOP display selection. Setting range: 0: STOP on PV display + STOP lamp (green) lights 1: STOP on SV display + STOP lamp (green) lights [Factory set value] 2: STOP lamp (green) lights</p>
Control output	<p>When the time-proportional control output: Output OFF</p> <p>When the continuous control output: Output of -5 %</p>
Event output Transmission output (AO)	<p>The output content depends on the setting of Output action at STOP mode. Setting range: 0: Both Event output and Transmission output (AO) are off. [Factory set value] 1: Event output remains unchanged, and Transmission output (AO) is off. 2: Event output is off, and Transmission output (AO) remains unchanged. 3: Both Event output and Transmission output (AO) remain unchanged.</p>
Autotuning (AT)	AT canceled (The PID constants are not updated)



For the settings of STOP display selection, and Output action at STOP mode, refer to **8.5 Engineering Mode (P. 8-96, P. 8-97)**.

● State of this instrument when set to RUN mode

If the instrument is transferred to RUN mode from STOP mode, it performs the same operation (control RUN, event determination start-up) as the power-on.

■ RUN/STOP transfer by front key operation

Press and hold the $\triangleleft_{R/S}$ key for 2 seconds or more at the PV/SV monitor screen and the instrument will switch from STOP to RUN.

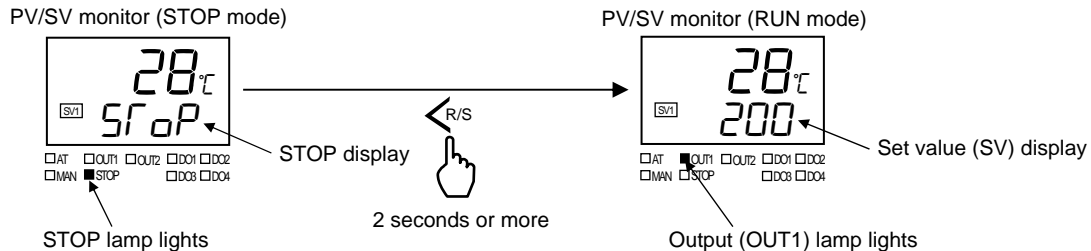

 To change from RUN mode to STOP mode, press and hold the $\triangleleft_{R/S}$ key for 2 seconds or more.

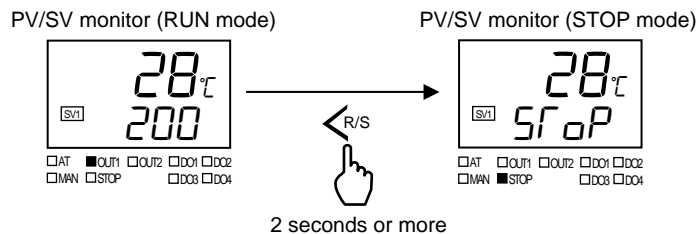

■ Performing RUN/STOP transfer in the “RUN/STOP setting” (Engineering mode)

● To change from RUN mode to STOP mode

1. Press the $\triangleleft_{R/S}$ key while pressing the SET key for 4 seconds or more at PV/SV monitor screen until Engineering mode is displayed. Function block 00 screen is displayed first.

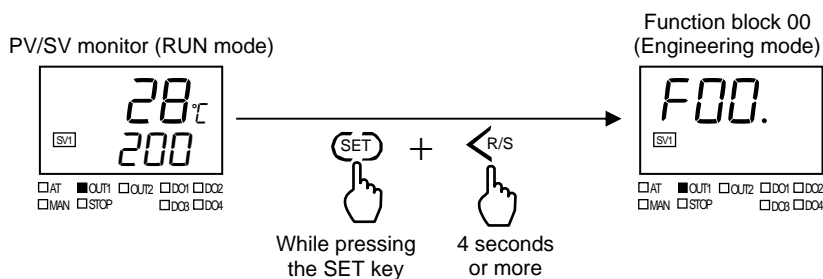

2. Press the SET key several times until RUN/STOP setting screen is displayed.

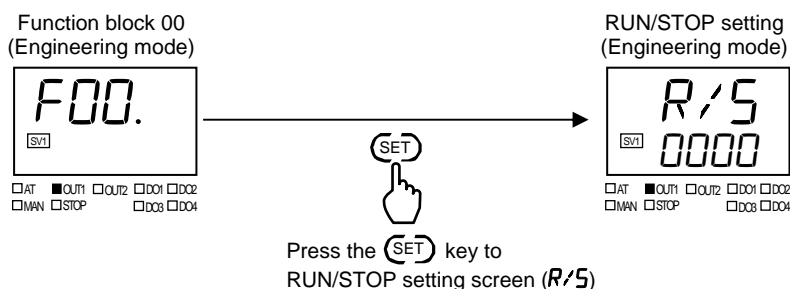

Continued on the next page.

3. Press the \wedge key to change the number to 1 (1: STOP).
Press the (SET) key to store the new value.

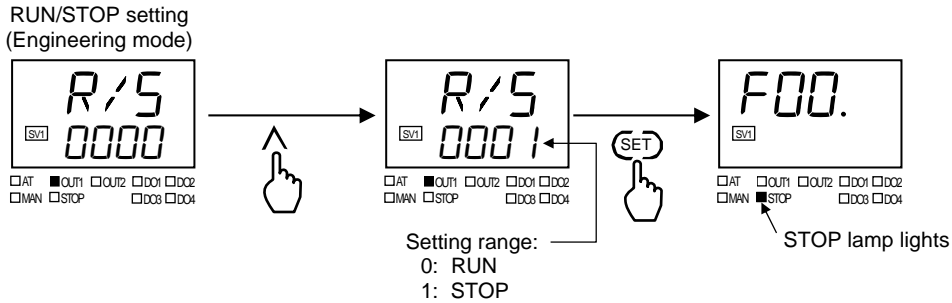

4. To return the PV/SV monitor, press the \leftarrow R/S key while pressing the (SET) key.

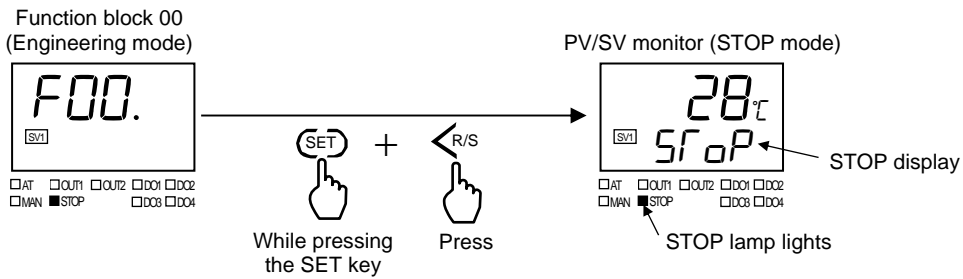

● To change from STOP mode to RUN mode

1. Press the \leftarrow R/S key while pressing the (SET) key for 4 seconds or more at PV/SV monitor screen until Engineering mode is displayed. Function block 00 screen is displayed first.

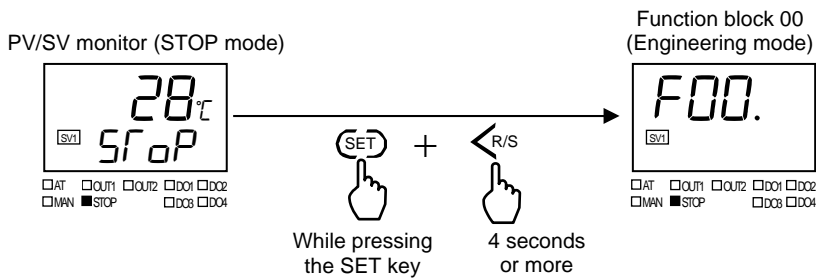

2. Press the (SET) key several times until RUN/STOP setting screen is displayed.

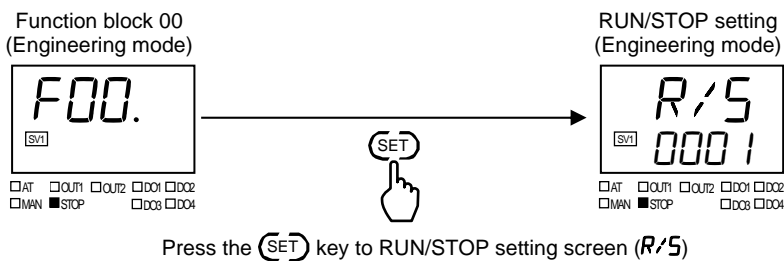

Continued on the next page.

3. Press the ∇ key to change the number to 0 (0:RUN).
Press the (SET) key to store the new value.

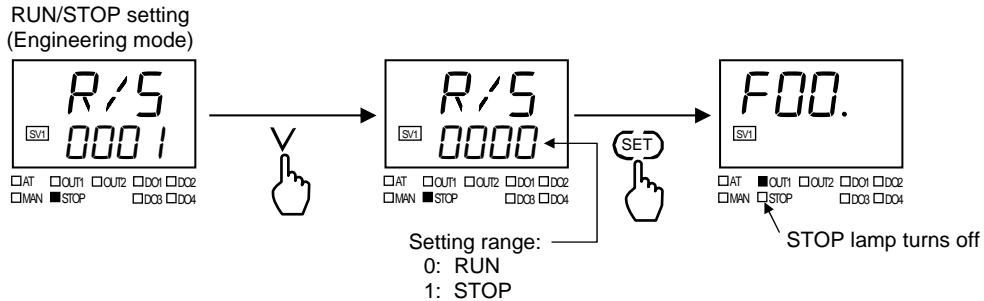

4. To return the PV/SV monitor, press the \leftarrow R/S key while pressing the (SET) key.

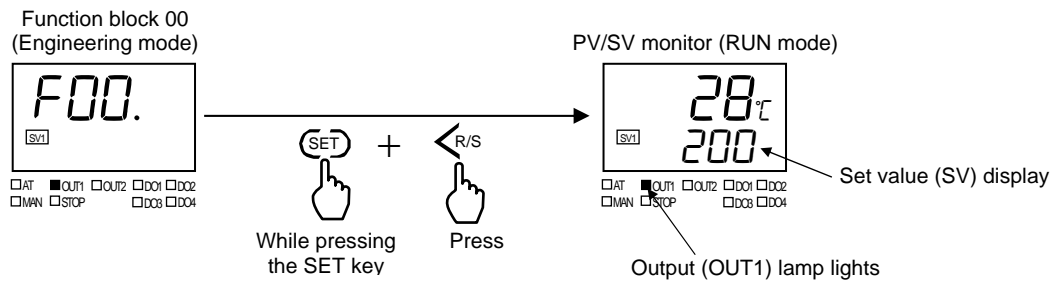

■ RUN/STOP transfer by digital input (DI) [optional]

RUN/STOP transfer by digital input (DI) is possible by assigning RUN/STOP transfer in DI assignment of Engineering mode. If RUN/STOP transfer is specified in the initial set codes when the order is placed, transfer will be automatic.

DI assignment/Initialize code

Set value	Code	DI1	DI2
2	2	SV1 to SV2 selection (SV selection function)	RUN/STOP transfer
5	5	RUN/STOP transfer	AUTO/MAN transfer
6	6	RUN/STOP transfer	Interlock release

For the DI assignment, refer to **8.5 Engineering Mode (P. 8-95)**.

Continued on the next page.

● **Terminal configuration**

When the initial set code of DI assignment is “2: SV1 to SV2 selection + RUN/STOP transfer”

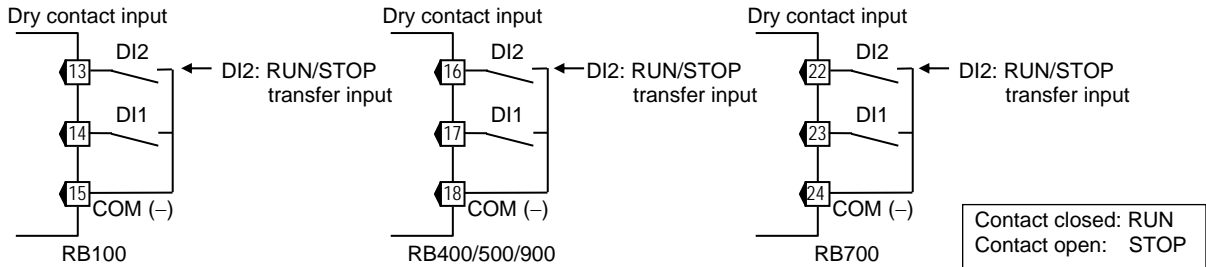

When the initial set code of DI assignment is “5: RUN/STOP transfer + AUTO/MAN transfer,”
 “6: RUN/STOP transfer + Interlock release”

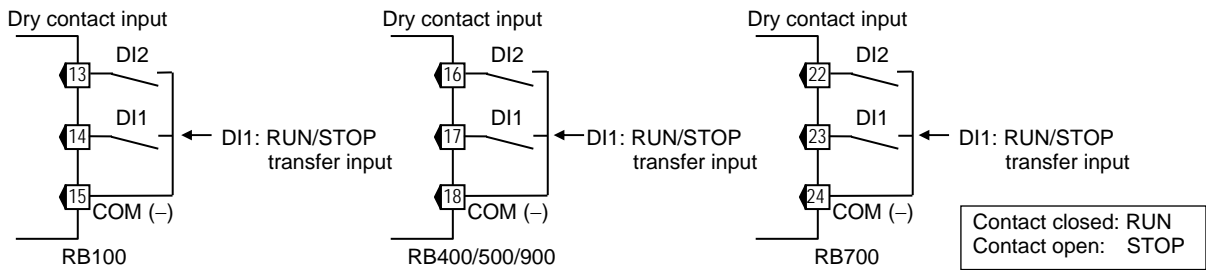

Contact input from external devices or equipment should be dry contact input. If it is not dry contact input, the input should meet the specifications below:
 Contact specifications: At OFF (contact open) 500 kΩ or more
 At ON (contact closed) 10 Ω or less

● **Transfer timing of RUN/STOP**

When the contact is closed, RUN. When the contact is open, STOP.

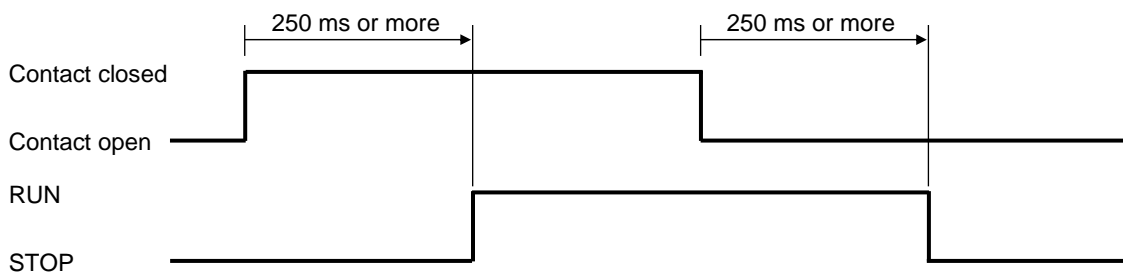

After the contact is transferred, it takes “250 ms + 1 sampling cycle*” until the action of this instrument is actually selected.

* Sampling cycle: 250 ms

● RUN/STOP transfer state

The table below shows the actual RUN/STOP modes, displays, and STOP lamp states under different combinations of settings by key operation, communication, digital input (DI), and STOP by the timer function.

RUN/STOP mode from key operation or communication	RUN/STOP mode by digital input (DI)	STOP by the Timer function	Actual RUN/STOP mode state	STOP lamp state	State of STOP (character)
RUN	Contact closed (RUN)	RUN	RUN	Turns off	STOP is not displayed
	Contact open (STOP)	—	STOP	Lighting	dSfP
STOP	Contact closed (RUN)	—		Lighting	LSfP
	Contact open (STOP)	—		Lighting	Sf dP
RUN	Contact closed (RUN)	STOP		Flashing	rSfP

* When digital input (DI) is used for transfer, the new state is not backed up to EEPROM.

● STOP character display

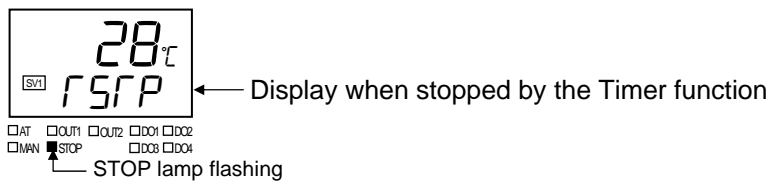
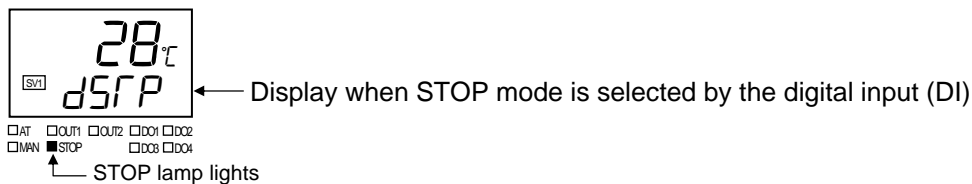
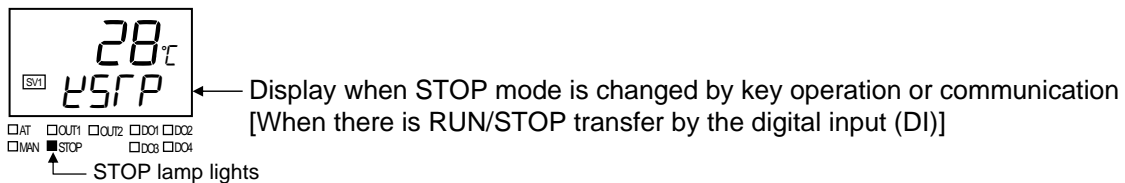
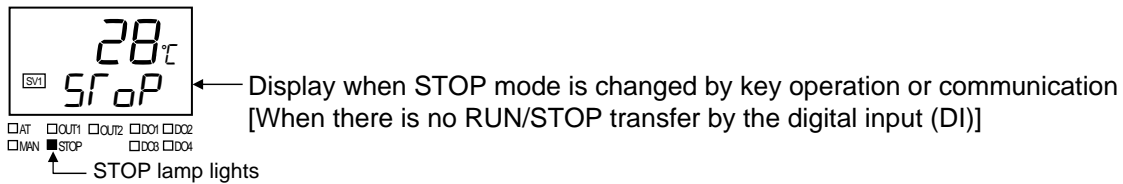

The display location (SV display or PV display) and display/no display setting of the STOP display can be changed in STOP display selection (F30) of the Engineering mode.

(P. 8-97)

6.2 Autotuning (AT)

The Autotuning (AT) function automatically measures, computes and sets the optimum PID values.

■ Caution for using the Autotuning (AT)

- When a temperature change (UP and/or Down) is 1 °C or less per minute during Autotuning (AT), Autotuning (AT) may not be finished normally. In that case, adjust the PID values manually. Manual setting of PID values may also be necessary if the set value is around the ambient temperature or is close to the maximum temperature achieved by the load.
- If the manipulated output value may be limited by the Output limiter setting, the optimum PID values may not be calculated by Autotuning (AT).

■ Requirements for Autotuning (AT) start

Start the Autotuning (AT) when all following conditions are satisfied:

To start Autotuning (AT), go to Parameter setting mode.

Operation state	PID control
	RUN
Parameter setting	Output limiter high ≥ 0.1 %, Output limiter low ≤ 99.9 % [Heat/Cool control type: Output limiter high (heat-side) ≥ 0.1 %, Output limiter high (cool-side) ≥ 0.1 %]
Input value state	The Measured value (PV) is not underscale or over-scale.

■ Requirements for Autotuning (AT) cancellation

If the Autotuning (AT) is canceled according to any of the following conditions, the controller immediately changes to PID control. The PID values will be the same as before Autotuning (AT) was activated.

Operation state	When the PID/AT transfer is changed to the PID control.
	When the RUN/STOP mode is changed to the STOP mode.
	When the Auto/Manual mode is changed to the Manual mode.
Parameter changing	Parameter changing
	When the PV bias or the PV digital filter is changed.
	When the Output limiter value is changed.
Input value state	When the Measured value (PV) goes to underscale or over-scale.
AT execution time	When the Autotuning (AT) does not end in 9 hours after Autotuning (AT) started.
Power failure	When the power failure of more than 20 ms occurs. (10 ms or more for RB100 with 24V AC/DC power supply.)
Instrument error	When the instrument is in the FAIL state.

■ Autotuning (AT) start/stop operation

The Autotuning function can start from any state after power on, during a rise in temperature or in stable control.

● Start AT

1. Press and hold the **(SET)** key for 2 seconds or more at the PV/SV monitor screen to go to the Parameter setting mode, and press the **(SET)** key to display the Autotuning (AT) screen.

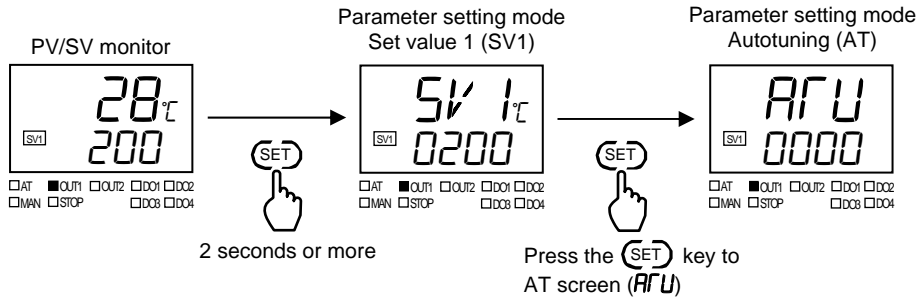

2. Press the **^** key to change the blinking digit from 0 to 1. Press the **(SET)** key and Autotuning will start. The AT lamp on the front panel will flash.

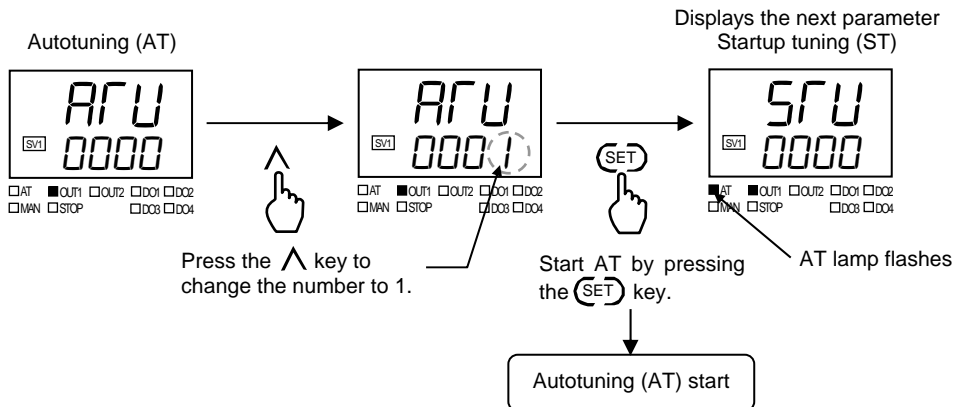

3. When the Autotuning (AT) is finished, the control will automatically returns to PID control and the AT lamp turns off.



If AT ends normally when LBA is set as the Event function, the LBA time is automatically set to twice the value of the Integral time.



After a new value is displayed on the display by using **^** and **v** keys, if no key operation is performed within 1 minute without pressing **(SET)** key, this instrument returns to the PV/SV monitor screen and the set value will not be changed.

● **Autotuning (AT) cancellation**

When canceling the Autotuning function (AT), press the **V** key to be set to “0000” with the Autotuning (AT) screen.

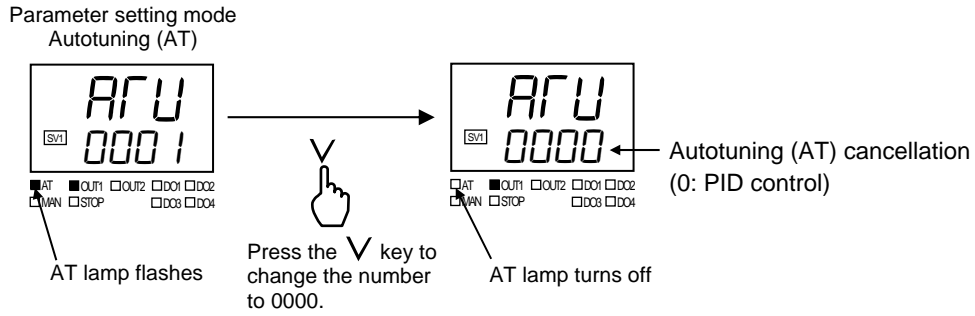

● **Return the PV/SV monitor**

To return the PV/SV monitor, press and hold the **(SET)** key for 2 seconds or more.

- **Hand icon** As the other parameters for Autotuning (AT) function, there are AT cycles, or AT differential gap time. For the each parameter, refer to **8.5 Engineering Mode (P. 8-130 to 8-131)**.

6.3 Startup Tuning (ST)

Startup tuning (ST) is a function which automatically computes and sets the PID values (Proportional band: heat-side only) from the response characteristics of the controlled system at power ON, transfer from STOP to RUN, and Set value (SV) change.

- As simple autotuning, the PID values can be found in a short time without disturbing controllability for controlled systems with slow response at power ON.
- For controlled systems which require different PID values for each temperature setting, the PID values can be found for each Set value (SV) change.

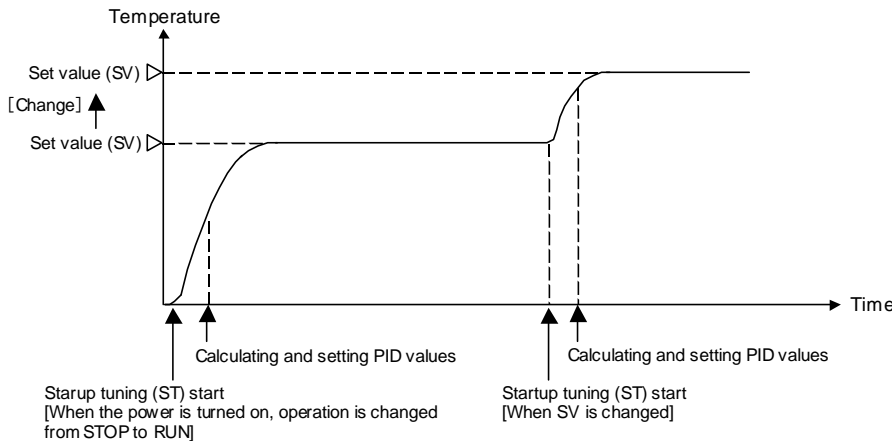

- The setting items related to Startup tuning (ST) are shown below. Set them according to the application used.

Setting item	Details		Setting mode
Start condition	0 (Factory set value)	When the power is turned on, operation is changed from STOP to RUN, or the Set value (SV) is changed.	Engineering mode
	1	When the power is turned on or operation is changed from STOP to RUN.	
	2	When the Set value (SV) is changed.	
Execution method	0 (Factory set value)	ST unused	Parameter setting mode
	1	Execute once	
	2	Execute always	



When the Startup tuning (ST) function is activated in Heat/Cool PID control, only heat-side PID values are calculated and changed (the Proportional band [cool-side] is not calculated).

■ Caution for using the Startup tuning (ST)

- For Startup tuning (ST) at power ON or transfer from STOP to RUN, always set the heater power to ON simultaneously with the start of tuning or before the start of tuning.
- Start Startup tuning (ST) in the state in which the temperature differential of the Measured value (PV) and Set value (SV) at the start of Startup tuning (ST) is twice the Proportional band, or greater.
- If in Heat/Cool PID control, start activating the Startup tuning (ST) function under the condition of “Set value (SV) > Measured value (PV).” Only the PID values on the heat-side are automatically calculated but no PID values on the cool-side are changed. Execute the Autotuning (AT) function to the PID valued on the cool-side.
- When the manipulated output value may be limited by the Output limiter setting, the optimum PID values may not be calculated by Startup tuning (ST).
- When setting the Setting change rate limiter, the optimum PID values are not obtained even when Startup tuning (ST) is executed at Set value (SV) change.

■ Requirements for Startup tuning (ST) start

Start the Startup tuning (ST) when all following conditions are satisfied:

Operation state	PID control
	RUN
Parameter setting	ST is set to ON. (Execute once, Execute always)
	Output limiter high $\geq 0.1\%$, Output limiter low $\leq 99.9\%$ [Heat/Cool control type: Output limiter high (heat-side) $\geq 0.1\%$]
Input value state	The Measured value (PV) is not underscale or over-scale.
	At ST at setting change, the Measured value (PV) shall be stabilized.
	Set value (SV) > Measured value (PV) [Heat/Cool PID control]
Output value state	At startup, output is changed and saturated at the Output limiter high or the Output limiter low [Heat/Cool control type: Output limiter high (heat-side)].

■ Requirements for Startup tuning (ST) cancellation

If the Startup tuning (ST) is canceled according to any of the following conditions, the controller immediately changes to PID control. The PID values will be the same as before Startup tuning (ST) was activated.

Operation state	When the Autotuning (AT) is activated.
	When the RUN/STOP mode is changed to the STOP mode.
	When the Auto/Manual mode is changed to the Manual mode.
Parameter changing	When Startup tuning (ST) is set to "0 (ST unused)."
	When the PV bias or the PV digital filter is changed.
	When the Output limiter value is changed.
Input value state	When the Measured value (PV) goes to underscale or over-scale.
Startup tuning (ST) execution time	When the Startup tuning (ST) does not end in hundred minutes after Startup tuning (ST) started
Power failure	When the power failure of more than 20 ms occurs. (10 ms or more for RB100 with 24V AC/DC power supply.)
Instrument error	When the instrument is in the FAIL state.

■ Startup tuning (ST) setting

The setting procedure when **executing Startup tuning (ST) only one time at power ON** is shown below as a setting example.

● Set the ST start condition

First, set “When the power is turn on” to ST start condition by Engineering mode.

1. Change the operation mode from RUN mode to STOP mode.

Press and hold the \leftarrow R/S key for 2 seconds or more at the PV/SV monitor screen, then instrument will go to RUN mode from STOP mode.

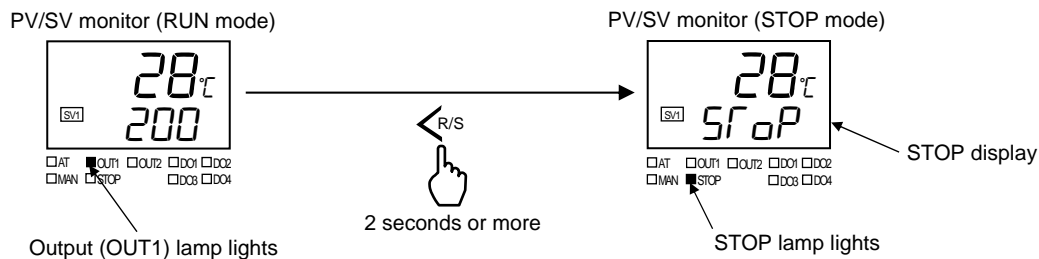

To change from RUN mode to STOP mode, refer to **6.1 RUN/STOP Transfer (P. 6-3)**.

2. Press the \leftarrow R/S key while pressing the (SET) key for 4 seconds or more at PV/SV monitor screen until Engineering mode is displayed. Function block 00 screen is displayed first.

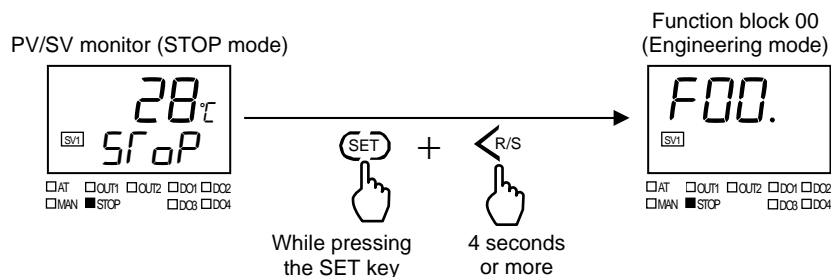

3. Configure settings to display Function block 21 and following of Engineering mode.

① Press the (SET) key several times until Mode selection (no display) screen will be displayed.

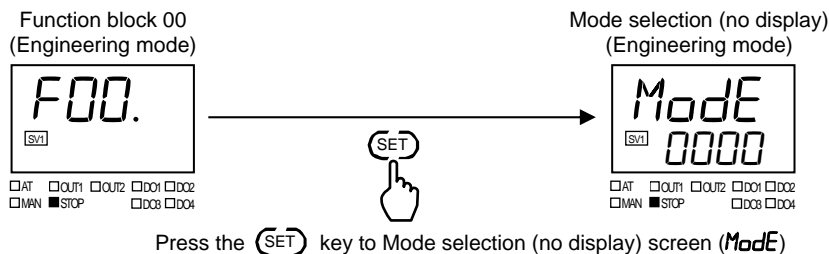

Continued on the next page.

- ② Set “128” (128: Display F21 and following) in the Mode selection (no display) screen and then press the (SET) key to store the set value. Press the (SET) key several times until the Function block 00 screen is displayed.

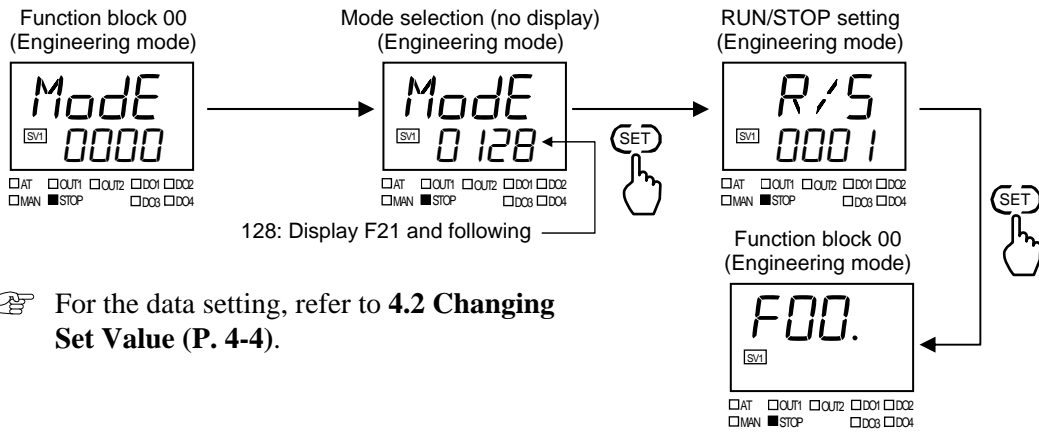

4. Press the (V) key several times until Function block 52 screen is displayed.

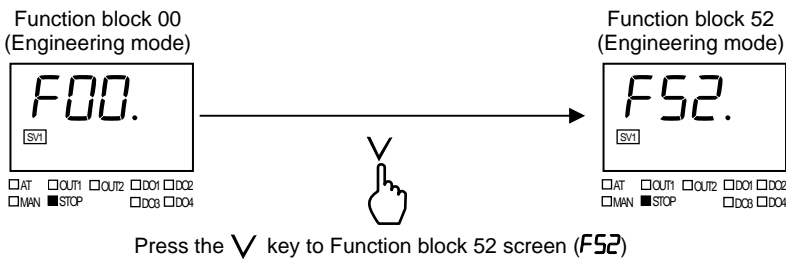

5. Press the (SET) key several times until ST start condition screen will be displayed.

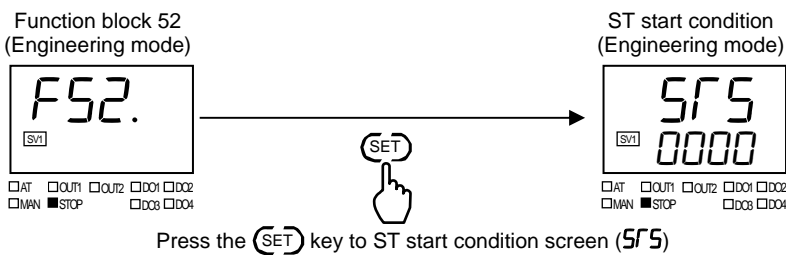

6. Press the (∧) key to change the number to 1 (1: Activate the ST function when the power is turned on). Press the (SET) key to store the new value.

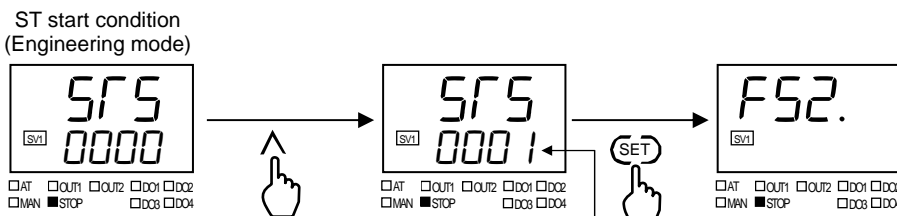

- 0: Activate the ST function when the power is turned on; when transferred from STOP to RUN; or when the set value (SV) is changed.
- 1: Activate the ST function when the power is turned on; or when transferred from STOP to RUN.
- 2: Activate the ST function when the set value (SV) is changed.

Continued on the next page.

7. Press the \wedge key several times until Function block 00 screen is displayed.
8. Press the SET key several times until Mode selection (no display) screen is displayed.
Change the value in the Mode selection (no display) screen to the original value and then press the SET key to store the set value.
9. To return the PV/SV monitor, press the \leftarrow key while pressing the SET key.



After a new value is displayed on the display by using \wedge and \vee keys, if no key operation is performed within 1 minute without pressing SET key, this instrument returns to the PV/SV monitor screen and the set value will not be changed.

● Set the execution method

Set that the Startup tuning (ST) will be executed only once.

1. Change the operation mode from STOP mode to RUN mode.

Press and hold the \leftarrow key for 2 seconds or more at the PV/SV monitor screen, then instrument will go to RUN mode from STOP mode.

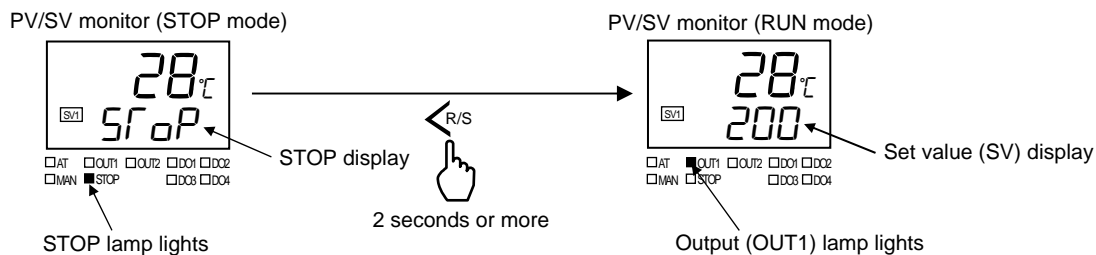

To change from STOP mode to RUN mode, refer to **6.1 RUN/STOP Transfer (P. 6-3)**.

2. Press and hold the SET key for 2 seconds or more at PV/SV monitor screen until Parameter setting mode is displayed.

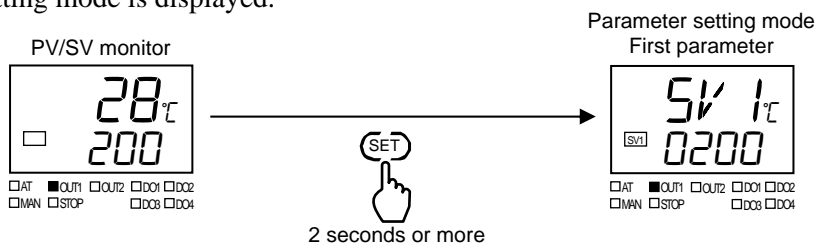

3. Press the SET key several times until Startup tuning (ST) screen will be displayed.

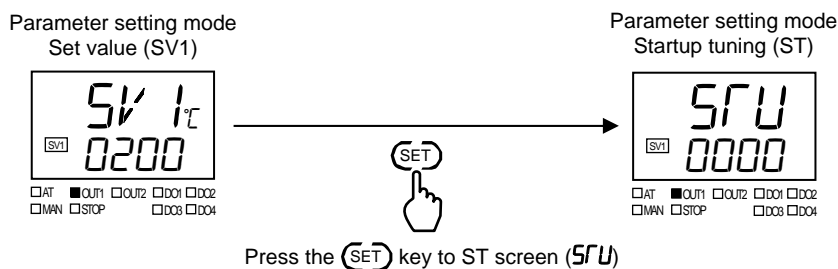

Continued on the next page.

- In the Startup tuning (ST) screen, press the \wedge key to set the value of the flashing digit to “1” (1: Execute once). Press the SET key to store the new value.

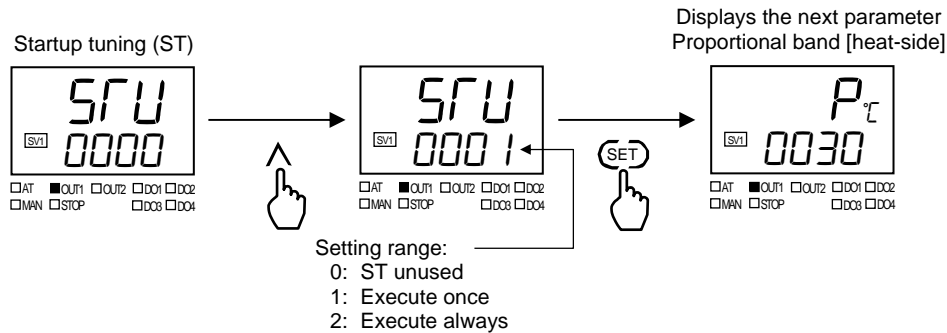

- Thus, the Startup tuning (ST) setting has been finished.
To return the PV/SV monitor, press and hold the SET key for 2 seconds or more.

After a new value is displayed on the display by using \wedge and \vee keys, if no key operation is performed within 1 minute without pressing SET key, this instrument returns to the PV/SV monitor screen and the set value will not be changed.

● **Start the ST**

Turn off the power once and turn it on again. The Startup tuning (ST) will automatically start (During ST execution: AT lamp lights). When the calculation and setting of PID values is completed, setting of the Startup tuning (ST) screen will automatically change to “0” (0: ST unused). (ST is completed: AT lamp turns off)

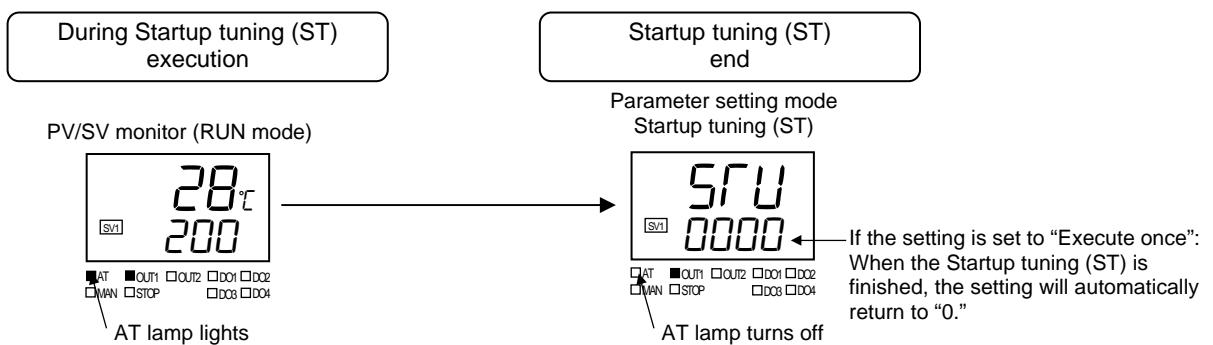

When Startup tuning (ST) was interrupted, the setting does not change to “0” (0: ST unused). Startup tuning (ST) starts when the restart conditions are satisfied.

If Startup tuning (ST) ends normally when LBA is set as the Event function, the LBA time is automatically set to twice the value of the Integral time.

6.4 Fine Tuning

The Fine tuning function allows you to change the response of the set PID constant control.

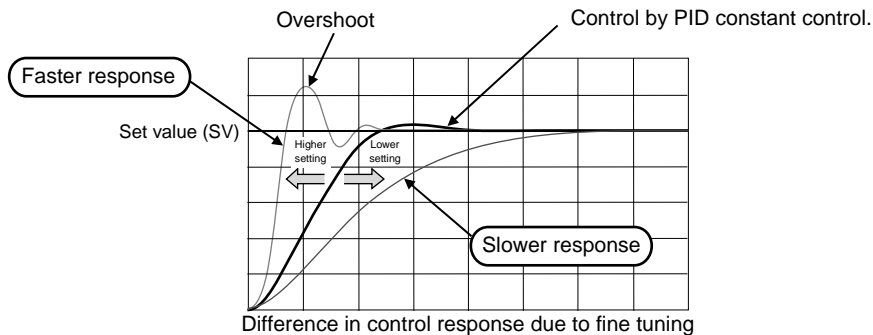

■ To make control response faster

When the control response is set to the fast side, the Measured value (PV) will reach the Set value (SV) more quickly, however, overshoot will be unavoidable.

1. Press and hold the **(SET)** key for 2 seconds or more at PV/SV monitor screen until Parameter setting mode is displayed.

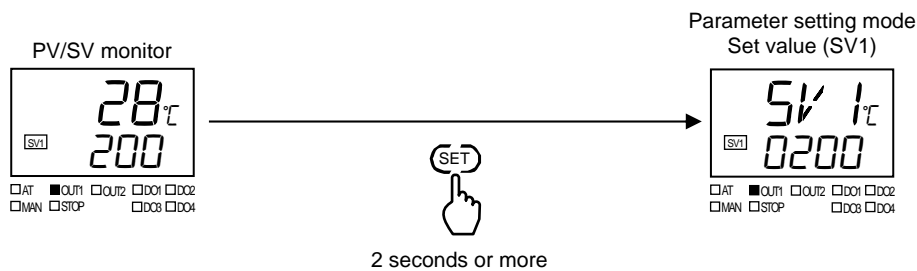

2. Press the **(SET)** key until Fine tuning setting screen is displayed.

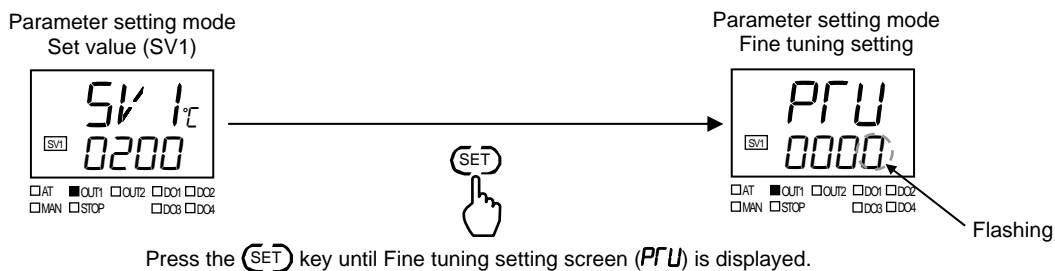

3. Press the **^** key to make the control response faster. A value from +1 to +3 will give a faster control response. The larger the value, the faster the control response.

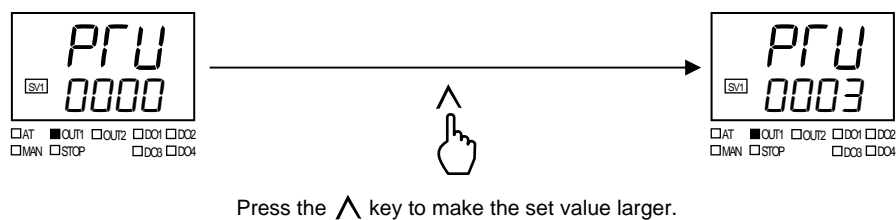

Continued on the next page.

Continued from the previous page.

- Press the **(SET)** key to store the new value. The display goes to the next parameter.
Fine tuning begins when the **(SET)** key is pressed.

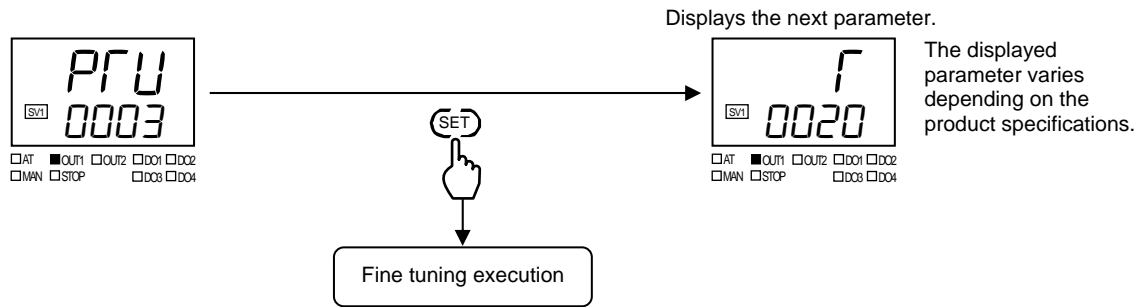

■ To make the control response slower

When the control response is set to slow side, overshoot is suppressed. However, it takes more time for the Measured value (PV) to reach the Set value (SV).

- Press and hold the **(SET)** key for 2 seconds or more at PV/SV monitor screen until Parameter setting mode is displayed.

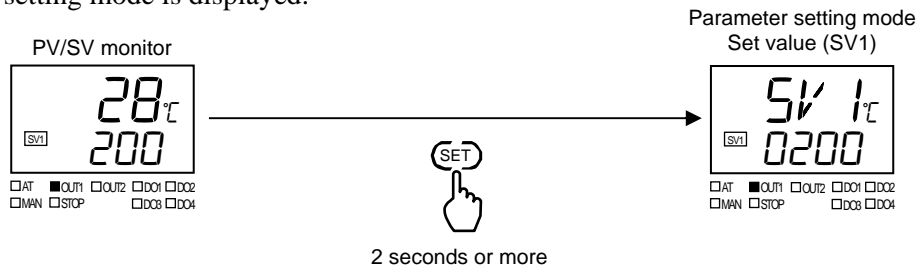

- Press the **(SET)** key until Fine tuning setting screen is displayed.

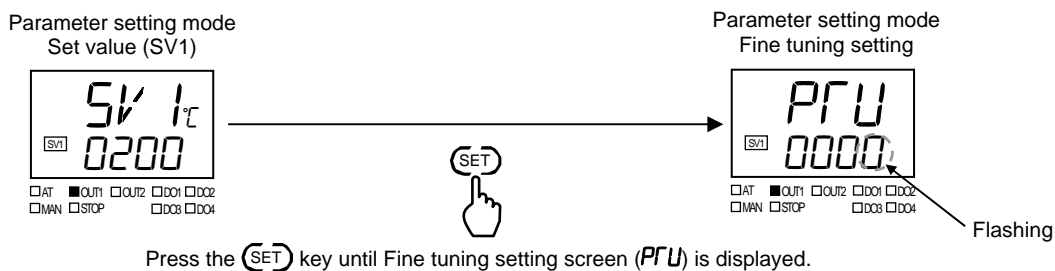

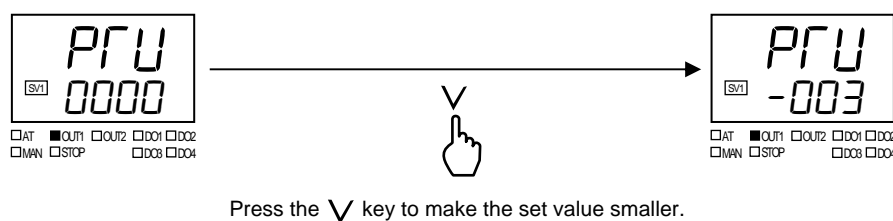

- Press the **∇** key to make the control response slower. A value from -1 to -3 will give a slower control response. The smaller the set value, the slower the control response.

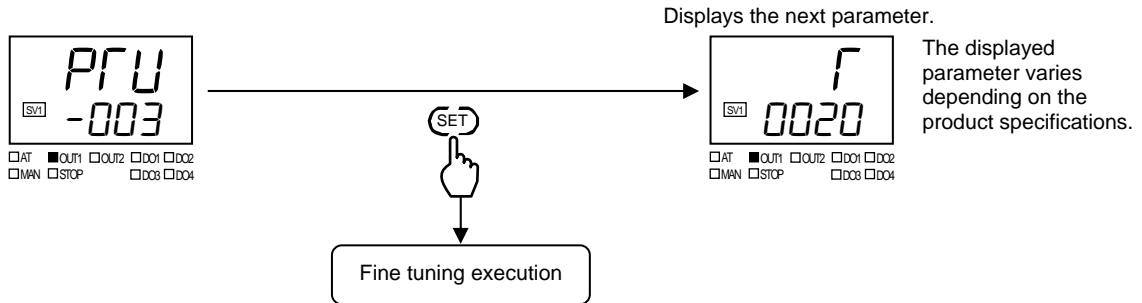

4. Press the **(SET)** key to store the new value. The display goes to the next parameter.
Fine tuning begins when the **(SET)** key is pressed.



-  If the set value of Fine tuning is returned to “0: Unused,” fine tuning correction will be turned off.
-  After a new value is displayed on the display by using **^** and **v** keys, if no key operation is performed within 1 minute without pressing **(SET)** key, this instrument returns to the Monitor display mode and the set value will not be changed.

6.5 Auto/Manual Transfer

The Auto/Manual transfer can be made by digital input (DI)* or communication* other than the key operation. * Optional

-  For details of Auto/Manual transfer by communication, refer to the **Communication Instruction Manual (IMR02C16-E□)**.

■ Bumpless function with Auto/Manual transfer

● When the instrument is switched from Manual (MAN) mode to Auto (AUTO) mode

When the instrument is switched from Manual (MAN) mode to Auto (AUTO) mode, the instrument determines the state of the Measured value (PV) and performs the following processing:

- If the Measured value (PV) is within the Proportional band [heat-side] or the Proportional band [cool-side], the Bumpless function will be activated.
- If the Measured value (PV) is outside of the Proportional band [heat-side] or the Proportional band [cool-side], the Bumpless function will not be activated.
- When Heat/Cool PID control is performed, the Bumpless function will work as described below depending on the preset Manual manipulated output value (MV):

When the Manual manipulated output value (MV) is a positive value:

The Bumpless function results in heat-side output.

When the Manual manipulated output value (MV) is a negative value:

The Bumpless function results in cool-side output.

● When the instrument is switched from Auto (AUTO) mode to Manual (MAN) mode

It can be set whether the Bumpless function is ON or OFF when the instrument is switched from Auto (AUTO) mode to Manual (MAN) mode. The following processing is performed depending on Bumpless function ON or OFF.

- If the Bumpless function is set to OFF, the preset Manual manipulated output value (MV) will be output.
- If the Bumpless function operates is set to ON, the Manipulated output value (MV) of Auto (AUTO) mode will be maintained as the output of Manual (MAN) mode.
- When Heat/Cool PID control is performed, the Bumpless function will work as described below (When the Bumpless function is valid (ON))

When heat-side output is output in Auto (AUTO) mode:

The Bumpless function results in the Manual manipulated output value (MV) to be a positive value.

When only cool-side output is output in AUTO mode:

The Bumpless function results in the Manual manipulated output value (MV) to be a negative value.

When the heat-side output and cool-side output are both 0 or less than 0 % in AUTO mode:

The Bumpless function results in the Manual manipulated output value (MV) to be 0 %.

■ Auto/Manual transfer by front key operation

This is performed in Auto/Manual transfer of Mode switching. Auto/Manual transfer can be done in the Mode switching. Every time the \wedge key or the \vee key is pressed, the Auto (AUTO) mode is changed to the Manual (MAN) mode alternately. Press the (SET) key to store the mode.

1. In PV/SV monitor, press the \leftarrow /R/S key while pressing the (SET) key.

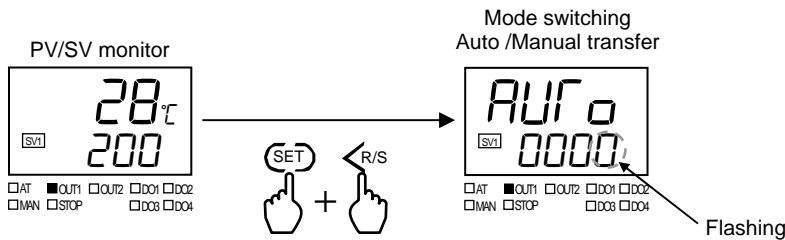

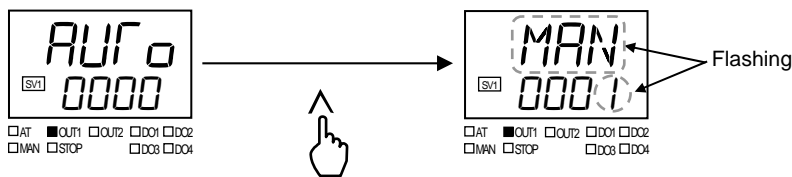

2. Press the \wedge key to change to Manual (MAN) mode. Then, the parameter symbol on the PV display will change to **MAN**, and the set value on the SV display to 1.

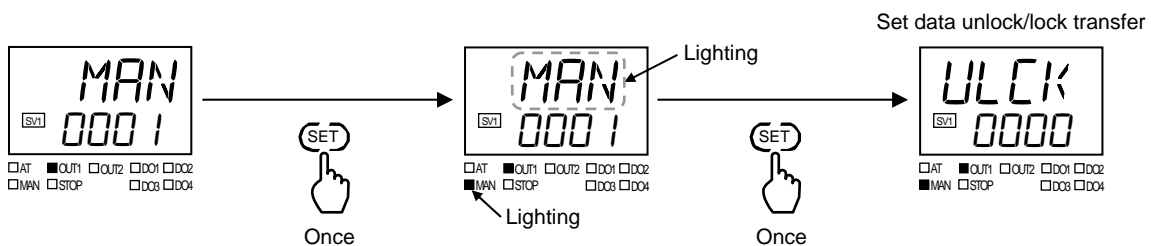

 Press \vee key to switch to Auto (AUTO) mode.

3. Press the (SET) key twice to store the set mode.
The display goes to the next parameter.



 After a new value is displayed on the display by using \wedge and \vee keys, if no key operation is performed within 1 minute without pressing (SET) key, this instrument returns to the Monitor display mode and the set value will not be changed.

■ **Auto/Manual transfer by digital input (DI)**

Auto/Manual transfer by the digital input (DI) is possible with the DI assignment of the Engineering mode.

👉 For the DI assignment, refer to **8.5 Engineering Mode (P. 8-95)**.

● **Terminal configuration**

Digital input (DI1, DI2)

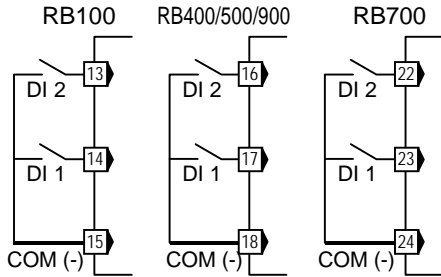

DI1 or DI2: Auto/Manual transfer input
 Contact closed: Auto (AUTO) mode
 Contact open: Manual (MAN) mode

Contact input from external devices or equipment should be dry contact input. If it is not dry contact input, the input should have meet the specifications below.

Contact specifications: At OFF: (contact open) 500 kΩ or more
 At ON: (contact closed) 10 Ω or less

● **Transfer timing of Auto/Manual**

When the contact is closed, the mode will be AUTO, and when the contact is open, the mode will be MAN.

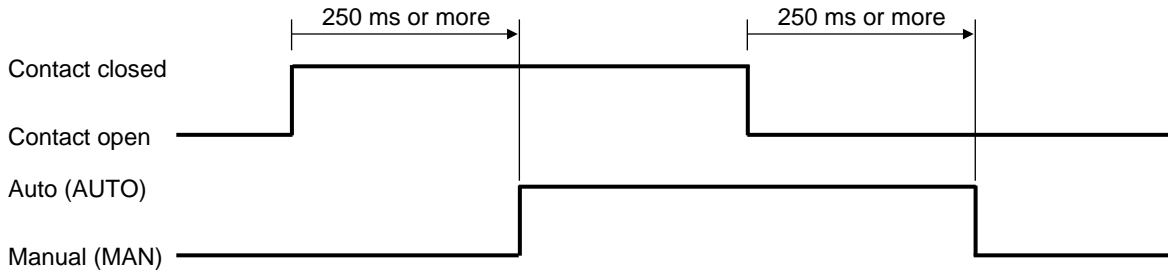

📖 **After the contact is transferred, it takes “250 ms + 1 sampling cycle*” until the action of this instrument is actually selected.**

* Sampling cycle: 250 ms

📖 When the Auto/Manual state is changed by digital input (DI), the Auto/Manual state in EEPROM will not be overwritten.

● **Auto/Manual transfer state**

The table below shows the actual Auto/Manual modes and displays under different combinations of settings by key operation, communication, and digital input (DI).

Auto/Manual select from key operation or communication	Auto/Manual select by digital input (DI) *	Actual Auto/Manual state	Indication lamp state
Auto (AUTO) mode	Contact closed [Auto (AUTO) mode]	Auto (AUTO) mode	MAN lamp turns off
	Contact open [Manual (MAN) mode]	Manual (MAN) mode	MAN lamp lights
Manual (MAN) mode	Contact closed [Auto (AUTO) mode]		
	Contact open [Manual (MAN) mode]		

* When digital input (DI) is used for transfer, the new state is not backed up to EEPROM.

■ Procedure for setting the Manipulated output value (MV) in Manual mode

When the controller is in Manual mode, the Manipulated output value (MV) can be manually set.

1. Make sure the Manual (MAN) mode lamp is lit.

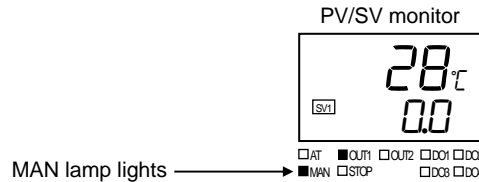

2. Press the **(SET)** key at PV/SV monitor until SV setting mode is displayed.

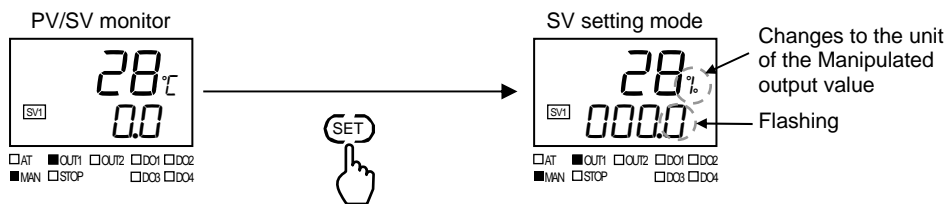

3. Set the Manipulated output value (MV) by **∧** or **∨** keys.

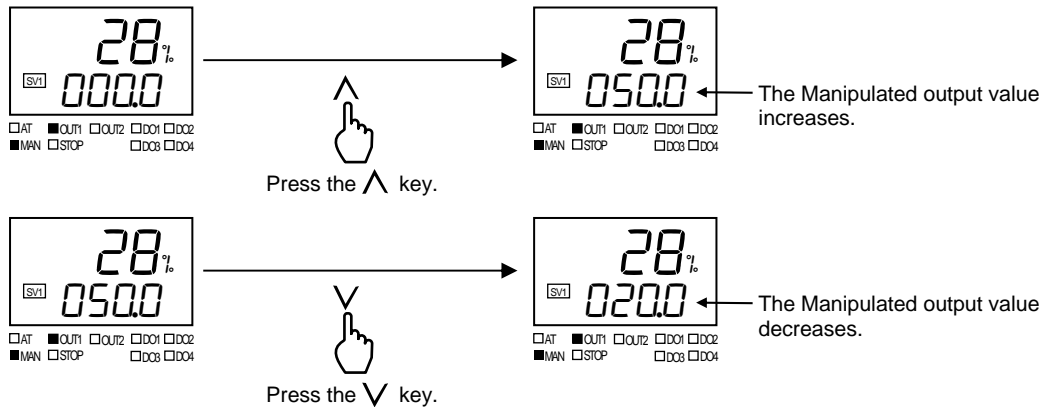

4. Press the **(SET)** key to store the new Manipulated output value (MV).

The display goes to the PV/SV monitor.

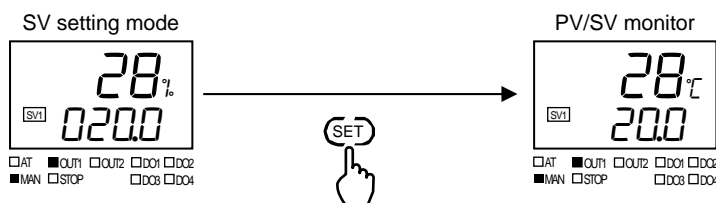

After a new value is displayed on the display by using **∧** and **∨** keys, if no key operation is performed within 1 minute without pressing **(SET)** key, this instrument returns to the Monitor display mode and the set value will not be changed.



The Manipulated output value (MV) of SV setting mode is linked to the Manual manipulated output value (MV) of Parameter setting mode and Engineering mode. The Manual manipulated output value (MV) can also be changed by changing the Manual manipulated output value (MV) of Parameter setting mode and Engineering mode.

The Manual manipulated output value (MV) of Parameter setting mode is not displayed by factory default. To display it, set “0: Display” in F10 block selection (no display) (P. 8-87) of Engineering mode.

6.6 Protecting Setting Data (Data lock function)

To protect setting data in the instrument, the setting data can be locked so that no changes can be made (Data lock function). Parameters that can be locked are described below.

- Parameters of Parameter setting mode
- Parameters of Function block 01 (F01) to Function block 10 (F10) of Engineering mode
- Parameters of Function block 21 (F21) to Function block 91 (F91) of Engineering mode
(Note that parameters of Function block 91 (F91) are for monitoring only)

■ Set lock level

- Parameter setting mode:
Parameters can be locked by a block of parameters, using a set lock level. A parameter in Parameter setting mode also belongs to a Function block of Engineering mode between Function block 01 (F01) and 10 (F10). By locking a block to which the parameter belongs, the parameter can be locked and all parameters in the same block and parameters in all blocks included in the same lock level are locked at the same time (P. 6-25).
- Function block 01 (F01) to Function block 10 (F10):
The data can be locked function block by Function block.
- Function block 21 (F21) to Function block 91 (F91):
The data of F21 to F91 can be locked altogether at the same time. The data cannot be locked for each Function block. When the data of F21 to F91 is locked, the screens of F21 to F91 are not displayed.

■ Setting procedure flowchart

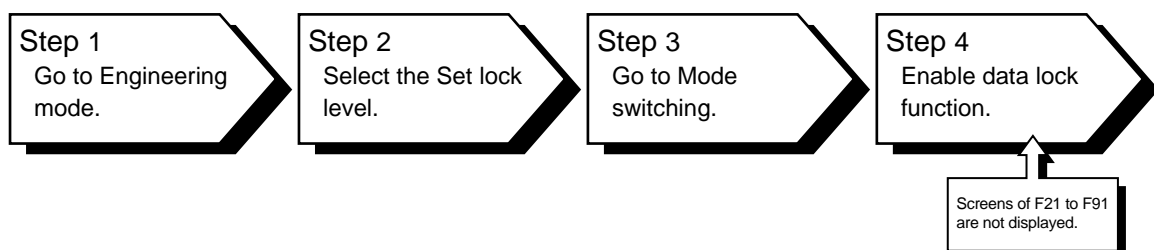

☞ For setting examples, refer to from P. 6-26 to P. 6-31.

■ Set lock level of Parameter setting mode

The same parameters exist in Engineering mode, grouped by group number (F01 to F10) as shown below. In the Set lock level (LocK) screen, you can lock the group number that contains the parameter(s) that you wish to lock, and this will lock the same parameters in Parameter setting mode. After Set lock level is stored, data lock will be effective by setting Set data unlock/lock transfer in Mode switching to “lock.”

Parameter setting mode		Set lock level (✓: Locked data)										
		Engineering mode (Set lock level [Lock])										
No.*		0	1	2	3	4	5	6	7	8	9	10
F01	Set value 1 (SV1) to Set value 4 (SV4) SV selection		✓									
F02	Timer 1 to Timer 4 Timer function Repeat execution time		✓	✓								
F03	Setting change rate limiter (up) Setting change rate limiter (down)		✓	✓	✓							
F04	Event 1 set value (EV1) Event 1 set value (EV1) [high] Event 1 set value (EV1') [low] Event 2 set value (EV2) Event 2 set value (EV2) [high] Event 2 set value (EV2') [low] Event 3 set value (EV3) Event 3 set value (EV3) [high] Event 3 set value (EV3') [low] Event 4 set value (EV4) Event 4 set value (EV4) [high] Event 4 set value (EV4') [low]		✓	✓	✓	✓						
F05	Autotuning (AT) Startup tuning (ST)		✓	✓	✓	✓	✓					
F06	Proportional band [heat-side] Integral time Derivative time Anti-reset windup (ARW) Proportional band [cool-side] Overlap/Deadband Fine tuning setting		✓	✓	✓	✓	✓	✓				
F07	Heater break alarm 1 (HBA1) set value Heater break alarm 2 (HBA2) set value Control loop break alarm (LBA) time LBA deadband (LBD)		✓	✓	✓	✓	✓	✓	✓			
F08	Proportional cycle time [heat-side] Minimum ON/OFF time of proportioning cycle [heat-side] Output limiter high [Heat-side output limiter (high)] Output limiter low [Cool-side output limiter (high)] Proportional cycle time [cool-side] Minimum ON/OFF time of proportioning cycle [cool-side]		✓	✓	✓	✓	✓	✓	✓	✓		
F09	PV bias PV digital filter		✓	✓	✓	✓	✓	✓	✓	✓	✓	
F10	Manual manipulated output value (MV)		✓	✓	✓	✓	✓	✓	✓	✓	✓	✓

* F01 to F10 indicate group numbers used in Set lock level in Engineering mode.

■ Locking all data which can be locked

Parameters that can be locked:

- Parameters of Parameter setting mode
- Parameters of F01 to F91 of Engineering mode

1. In PV/SV monitor, press the \leftarrow R/S key for 4 seconds or more while pressing the (SET) key. The display goes to the Engineering mode.

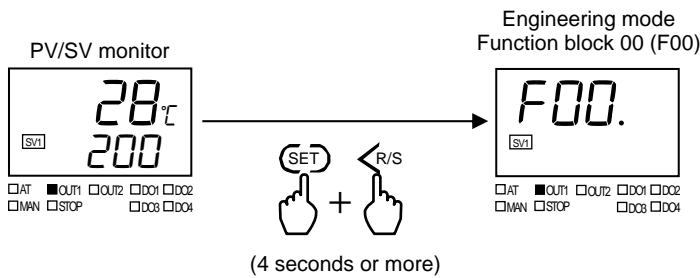

2. Press the (SET) key until Set lock level screen is displayed.

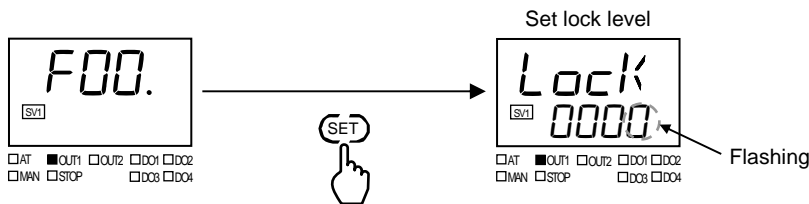

3. Press the \wedge key to change to 1.

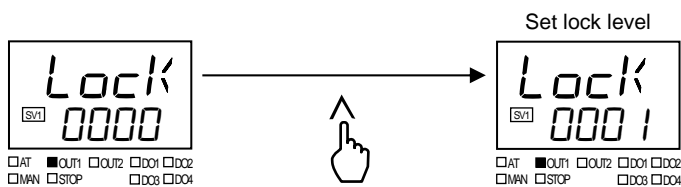

Set value and description

- 0: All parameter can be changed
- 1: Lock "Parameter Group" F01 through F10
- 2: Lock "Parameter Group" F02 through F10
- 3: Lock "Parameter Group" F03 through F10
- 4: Lock "Parameter Group" F04 through F10
- 5: Lock "Parameter Group" F05 through F10
- 6: Lock "Parameter Group" F06 through F10
- 7: Lock "Parameter Group" F07 through F10
- 8: Lock "Parameter Group" F08 through F10
- 9: Lock "Parameter Group" F09 and F10
- 10: Lock "Parameter Group" F10

4. Press the (SET) key to store the new value. The display goes to the next parameter.

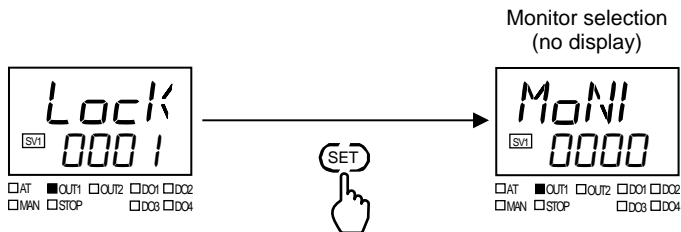

After a new value is displayed on the display by using \wedge and \vee keys, if no key operation is performed within 1 minute without pressing (SET) key, this instrument returns to the Monitor display mode and the set value will not be changed.

5. Press the $\leftarrow/R/S$ key while pressing the (SET) key. The display goes to the Engineering mode.

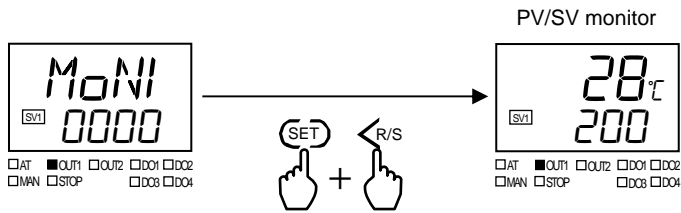

6. In PV/SV monitor, press the $\leftarrow/R/S$ key while pressing the (SET) key. The display goes to the Mode switching.

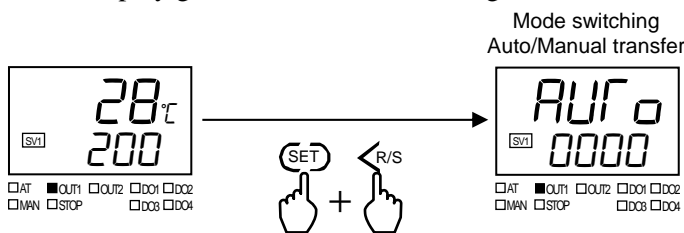

7. Press the (SET) key until Set data unlock/lock transfer screen is displayed.

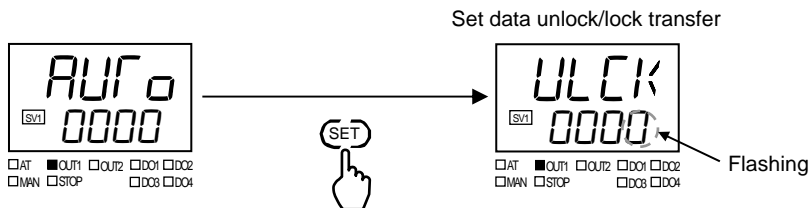

8. Press the \wedge key to change to 1. The parameter display will change to LCK and the set value will change to 1. Press the \vee key to change back to unlock ($ULCK$).

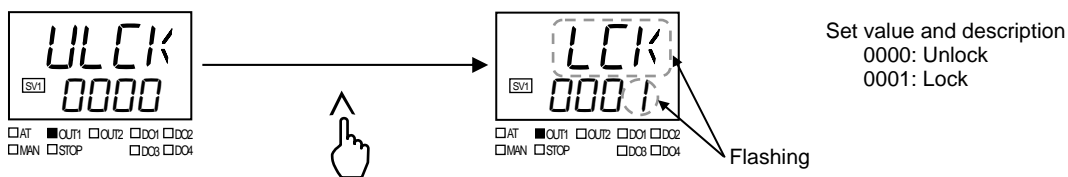

9. Press the (SET) key to store the new value. The parameter LCK will stop flashing. The parameters of Parameter setting mode and F10 to F91 are locked, and the setting data cannot be changed. ("F") will be displayed to indicate the locked state.)

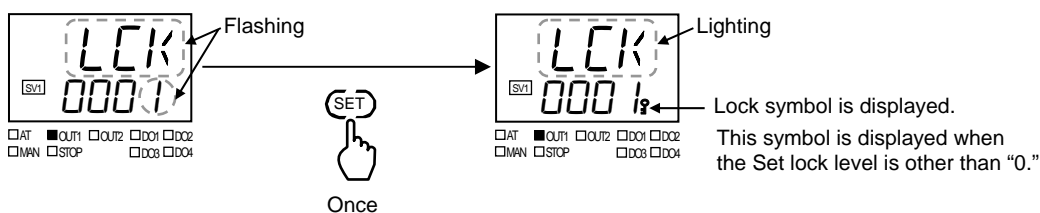

■ **Selecting the parameter to lock**

Setting example: Locking the Proportional band [heat-side] and following parameters in Parameter setting mode

To lock Proportional band [heat-side] and following parameters, choose a suitable Set lock level by which Function block F06 is locked. Set lock level “6: F06 to F10” so that all parameters in F06 to F10 will lock.

1. In PV/SV monitor, press the \leftarrow R/S key for 4 seconds or more while pressing the (SET) key. The display goes to the Engineering mode.

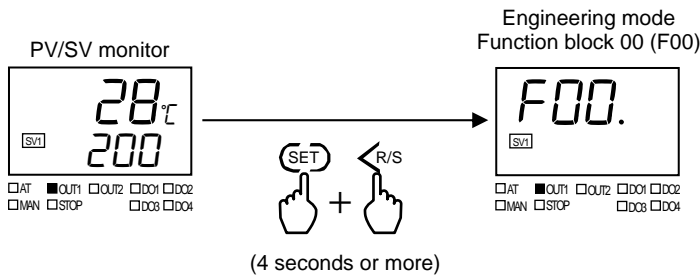

2. Press the (SET) key until Set lock level screen is displayed.

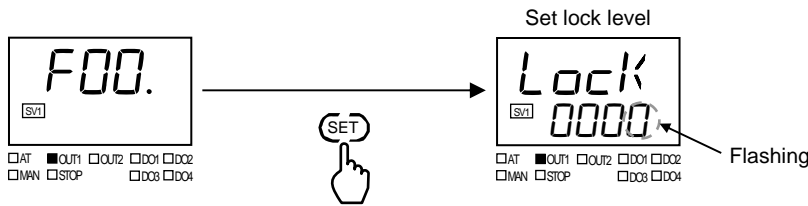

3. Press the ^ key to change to 6.

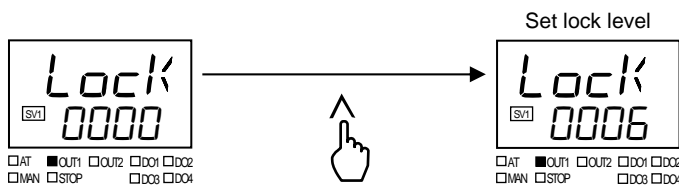

- Set value and description
- 0: All parameter can be changed
 - 1: Lock "Parameter Group" F01 through F10
 - 2: Lock "Parameter Group" F02 through F10
 - 3: Lock "Parameter Group" F03 through F10
 - 4: Lock "Parameter Group" F04 through F10
 - 5: Lock "Parameter Group" F05 through F10
 - 6: Lock "Parameter Group" F06 through F10
 - 7: Lock "Parameter Group" F07 through F10
 - 8: Lock "Parameter Group" F08 through F10
 - 9: Lock "Parameter Group" F09 and F10
 - 10: Lock "Parameter Group" F10

4. Press the (SET) key to store the new value. The display goes to the next parameter.

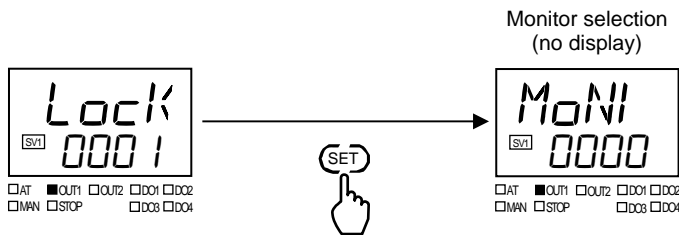

After a new value is displayed on the display by using ^ and v keys, if no key operation is performed within 1 minute without pressing (SET) key, this instrument returns to the Monitor display mode and the set value will not be changed.

5. Press the \leftarrow / R/S key while pressing the SET key. The display goes to the PV/SV monitor.

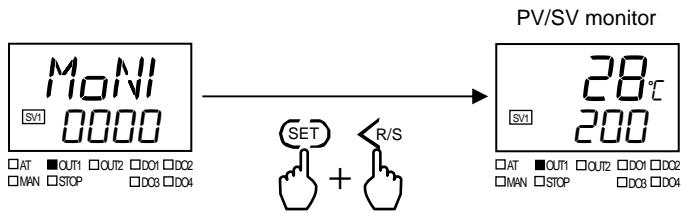

6. In PV/SV monitor, press the \leftarrow / R/S key while pressing the SET key.
The display goes to the Mode switching.

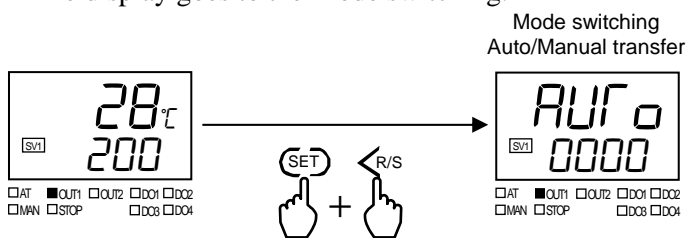

7. Press the SET key until Set data unlock/lock transfer screen is displayed.

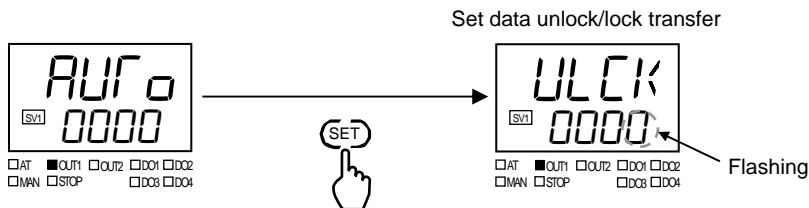

8. Press the \wedge key to change to 1. The parameter will change to LCK and the set value will change to 1. Press the \vee key to change back to unlock ($ULCK$).

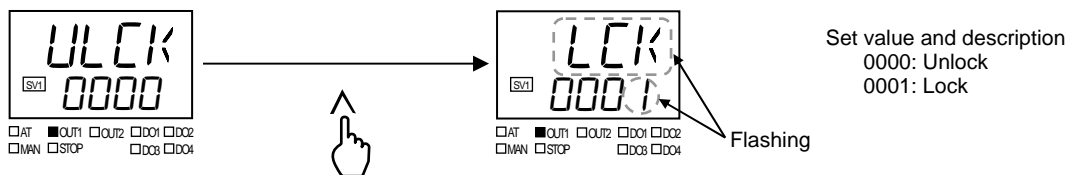

9. Press the SET key to store the new value. The parameter LCK will stop flashing. The Proportional band [heat-side] and following parameters in parameter mode and parameters in F06 to F91 are locked, and the setting data cannot be changed.
("🔒") will be displayed to indicate the locked state.)

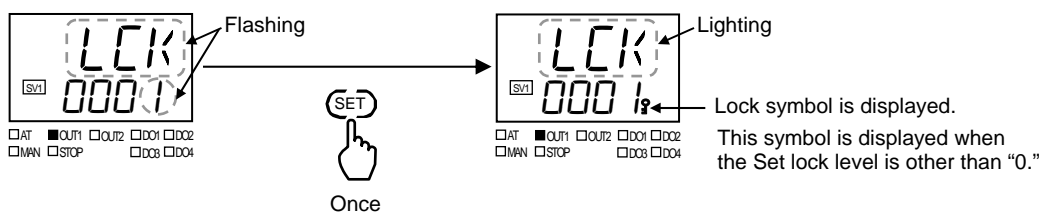

■ Locking F21 to F91 data

To lock F21 to F91, set any value from “1” to “10” in the Set lock level, and enable the Data lock function in the Set data unlock/lock screen.

When locked, the screens of F21 to F91 will not be displayed even if “128” is set in the Mode selection (no display) screen of F00 in either RUN or STOP mode.

1. In PV/SV monitor, press the \leftarrow R/S key for 4 seconds or more while pressing the (SET) key. The display goes to the Engineering mode.

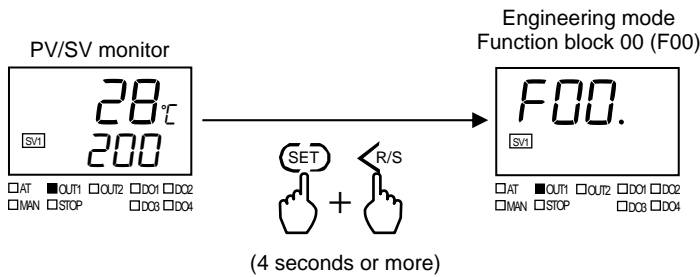

2. Press the (SET) key until Set lock level screen is displayed.

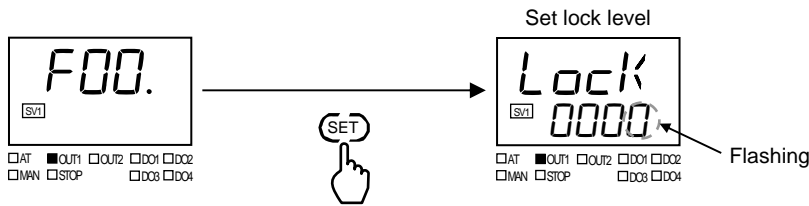

3. Press the \wedge key and set a value from “1” to “10.” (Here “1” is set as an example.)

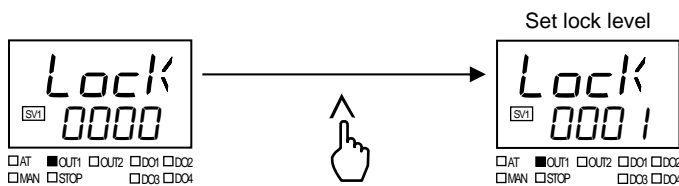

- Set value and description
- 0: All parameter can be changed
 - 1: Lock “Parameter Group” F01 through F10
 - 2: Lock “Parameter Group” F02 through F10
 - 3: Lock “Parameter Group” F03 through F10
 - 4: Lock “Parameter Group” F04 through F10
 - 5: Lock “Parameter Group” F05 through F10
 - 6: Lock “Parameter Group” F06 through F10
 - 7: Lock “Parameter Group” F07 through F10
 - 8: Lock “Parameter Group” F08 through F10
 - 9: Lock “Parameter Group” F09 and F10
 - 10: Lock “Parameter Group” F10

4. Press the (SET) key to store the new value. The display goes to the next parameter.

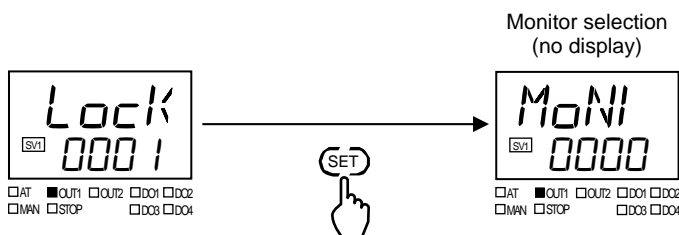

5. Press the \leftarrow / R/S key while pressing the (SET) key. The display goes to the PV/SV monitor.

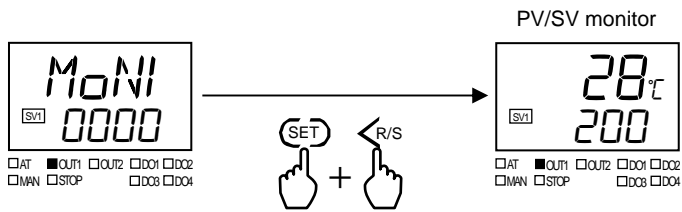

6. In PV/SV monitor, press the \leftarrow / R/S key while pressing the (SET) key. The display goes to the Mode switching.

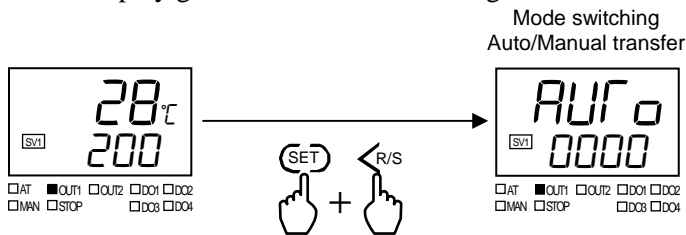

7. Press the (SET) key until Set data unlock/lock transfer screen is displayed.

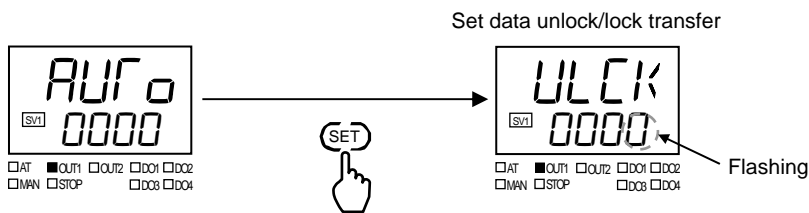

8. Press the \wedge key to change to 1. The parameter will change to LCK and the set value will change to 1 . Press the \vee key to change back to unlock ($ULCK$).

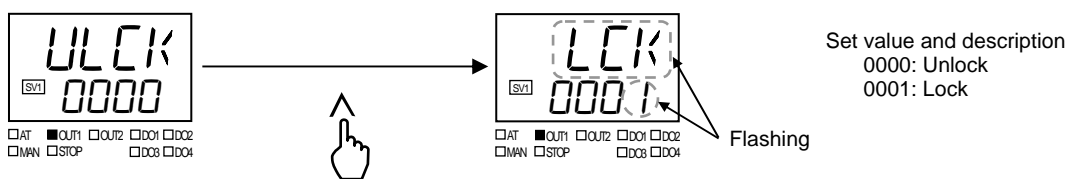

9. Press the (SET) key to store the new value. The parameter LCK will stop flashing. The parameters of F21 to F91 of Engineering mode are locked (no display), and the setting data cannot be changed. ("?" will be displayed to indicate the locked state.)

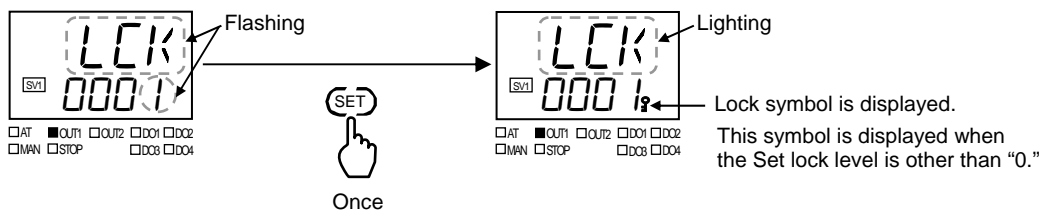

After a new value is displayed on the display by using \wedge and \vee keys, if no key operation is performed within 1 minute without pressing (SET) key, this instrument returns to the Monitor display mode and the set value will not be changed.

6.7 Display/No display Setting of Mode Screens

The instrument can be set not to display parameters that are not used (note that some parameters cannot be set to “no display”). Parameters that can be set to “no display” are shown below.

Monitor display mode:

PV/SV monitor
Current transformer 1 (CT1) input value monitor
Current transformer 2 (CT2) input value monitor
Manipulated output value (MV1) monitor [heat-side]
Manipulated output value (MV2) monitor [cool-side]
Remaining time monitor



Engineering mode (F00):

Cannot be set to no display.
Display/No display can be set in Monitor selection (no display) (ModM) [factory set value: 0 (Display all)].

SV setting mode: This mode cannot be set to no display.

Mode switching:

Auto (AUTO)/Manual (MAN) transfer
Set data unlock/lock transfer
Interlock release



Engineering mode (F00):

Display/No display can be set in Mode selection (no display) (ModE) [factory set value: 0 (Display all)].

Parameter setting mode:

Set value 1 (SV1) to Set value 4 (SV4) SV selection
Timer 1 to Timer 4 Timer function Repeat execution time
Setting change rate limiter (up) Setting change rate limiter (down)
Event 1 set value (EV1) to Event 4 set value (EV4) Event 1 set value (EV1) [high] to Event 4 set value (EV4) [high] Event 1 set value (EV1') [low] to Event 4 set value (EV4') [low]
Autotuning (AT) Startup tuning (ST)
Proportional band [heat-side] Integral time Derivative time Anti-reset windup (ARW) Proportional band [cool-side] Overlap/Deadband Fine tuning setting
Heater break alarm 1 (HBA1) set value Heater break alarm 2 (HBA2) set value Control loop break alarm (LBA) time LBA deadband (LBD)
Proportional cycle time [heat-side] Minimum ON/OFF time of proportioning cycle [heat-side] Output limiter high [Heat-side output limiter (high)] Output limiter low [Cool-side output limiter (high)] Proportional cycle time [cool-side] Minimum ON/OFF time of proportioning cycle [cool-side]
PV bias PV digital filter
Manual manipulated output value (MV)



Engineering mode (F01 to F10):

Display/No display can be set in F01 block selection (no display) (SF01) [factory set value: 1 (No display)].
Display/No display can be set in F02 block selection (no display) (SF02) [factory set value: 1 (No display)].
Display/No display can be set in F03 block selection (no display) (SF03) [factory set value: 1 (No display)].
Display/No display can be set in F04 block selection (no display) (SF04) [factory set value: 0 (Display)].
Display/No display can be set in F05 block selection (no display) (SF05) [factory set value: 0 (Display)].
Display/No display can be set in F06 block selection (no display) (SF06) [factory set value: 0 (Display)].
Display/No display can be set in F07 block selection (no display) (SF07) [factory set value: 0 (display all)].
Display/No display can be set in F08 block selection (no display) (SF08) [factory set value: 0 (Display)].
Display/No display can be set in F09 block selection (no display) (SF09) [factory set value: 0 (Display)].
Display/No display can be set in F10 block selection (no display) (SF10) [factory set value: 1 (No display)].

Engineering mode:

Function block 00 (F00) Function block 01 (F01) Function block 03 (F03) Function block 04 (F04) Function block 06 (F06) Function block 07 (F07) Function block 08 (F08) Function block 09 (F09) Function block 10 (F10)	⇒	Cannot be set to no display.
Function block 21 (F21) Function block 23 (F23) Function block 30 (F30) Function block 33 (F33) Function block 41 (F41) Function block 42 (F42) Function block 43 (F43) Function block 44 (F44) Function block 45 (F45) Function block 51 (F51) Function block 52 (F52) Function block 60 (F60) Function block 70 (F70) Function block 91 (F91)	⇒	Normally, these are set to no display. These can be displayed by setting “128” in Mode selection (no display) (<i>ModE</i>) of Function block 00 (F00) of Engineering mode. Note that display/no display selection by Function block (F□□) is not possible. <div style="text-align: center; margin: 10px 0;">  WARNING </div> Parameters in the Engineering mode (F21 to F70) should be set according to the application before setting any parameter related to operation. Once the parameters in the Engineering mode are set correctly, no further changes need to be made to parameters for the same application under normal conditions. If they are changed unnecessarily, it may result in malfunction or failure of the instrument. RKC will not bear any responsibility for malfunction or failure as a result of improper changes in the Engineering mode.



Some parameters may not be displayed depending on product specifications.

■ Hiding the parameters of the Monitor display mode

Setting example: The Current transformer 1 (CT1) input value monitor and Current transformer 2 (CT2) input value monitor are set to no display.

1. In PV/SV monitor, press the \leftarrow R/S key for 4 seconds or more while pressing the (SET) key. The display goes to the Engineering mode.

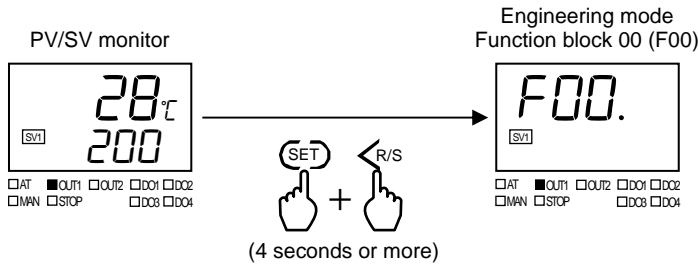

2. Press the (SET) key until Monitor selection (no display) screen is displayed.

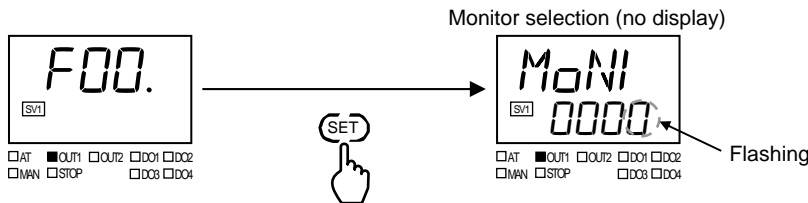

3. If there are multiple parameters to be set to no display, set the sum of the set values of the parameters. The set value of the Current transformer 1 (CT1) input value monitor is “1” and the set value of the Current transformer 2 (CT2) input value monitor is “2,” so “3” is entered as the total set value. Press the \wedge key to change to 3.

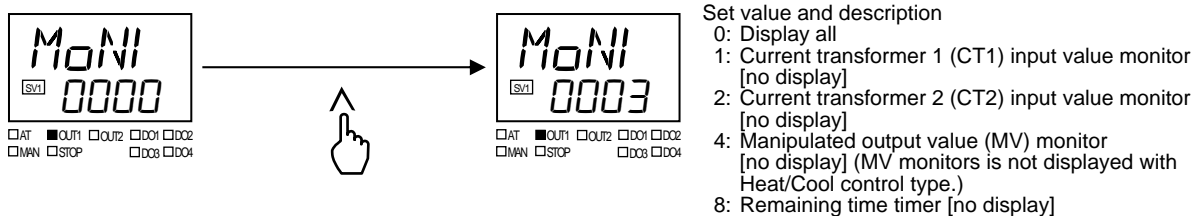

4. Press the (SET) key to store the new value. The display goes to the next parameter.

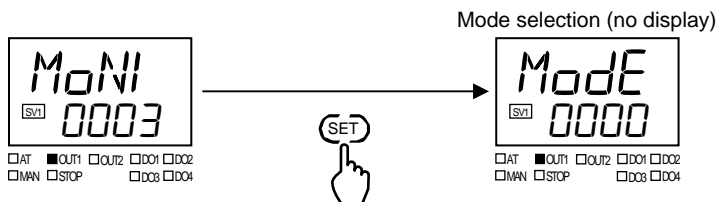

After a new value is displayed on the display by using \wedge and \vee keys, if no key operation is performed within 1 minute without pressing (SET) key, this instrument returns to the Monitor display mode and the set value will not be changed.

If specifications for the current transformer are not selected when ordering, the set value of the Current transformer 1 (CT1) input value monitor will be “1” and the Current transformer 2 (CT2) input value monitor will not be displayed initially.

■ Hiding the parameters of the Mode switching screen

Setting example: Set data unlock/lock transfer is set to no display.

1. In PV/SV monitor, press the \leftarrow R/S key for 4 seconds or more while pressing the (SET) key. The display goes to the Engineering mode.

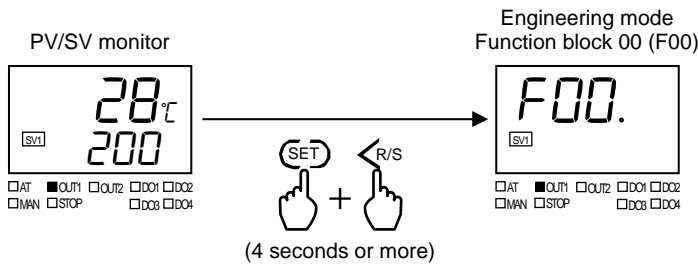

2. Press the (SET) key until Mode selection (no display) screen is displayed.

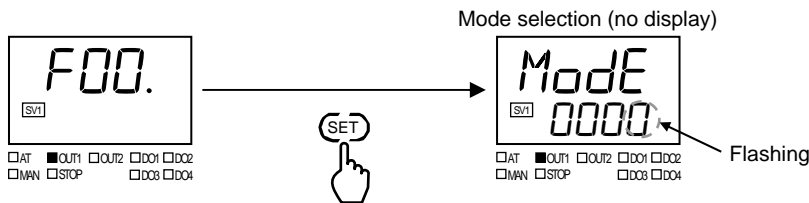

3. Press the \wedge key to change to 2.

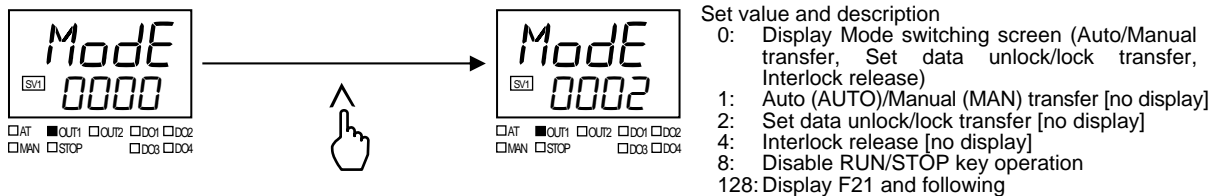

If there are multiple parameters to be set to no display, set the sum of the set values of the parameters.

4. Press the (SET) key to store the new value. The display goes to the next parameter.

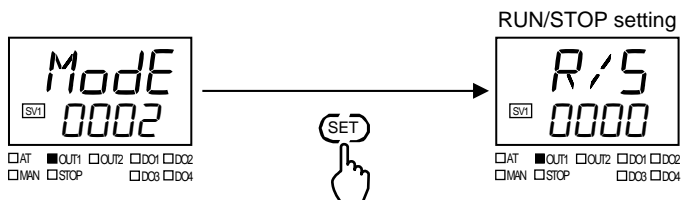

After a new value is displayed on the display by using \wedge and \vee keys, if no key operation is performed within 1 minute without pressing (SET) key, this instrument returns to the Monitor display mode and the set value will not be changed.



Screen displays of Function block 21 (F21) to Function block 91 (F91)



WARNING

Parameters in the Engineering mode (F21 to F70) should be set according to the application before setting any parameter related to operation. Once the parameters in the Engineering mode are set correctly, no further changes need to be made to parameters for the same application under normal conditions. If they are changed unnecessarily, it may result in malfunction or failure of the instrument. RKC will not bear any responsibility for malfunction or failure as a result of improper changes in the Engineering mode.

Display of F21 to F91 is set to “no display” as factory set value. To display F21 to F91, set mode selection (no display) screen to “128.”

To display F21 to F91 while any mode transfer screens are hidden, set mode selection (no display) screen parameter to the sum of the set value of the parameters.

Setting example: Display F21 to F91 while Set data unlock/lock transfer is hidden

Set “130,” the sum of the set value “2” of Set data unlock/lock transfer and “128.”

Mode selection (no display)

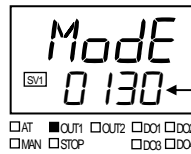

“130,” the sum of set value “2” of Set data unlock/lock transfer and set value “128” that displays F21 and following

■ Hiding the parameters of the Parameter setting mode

Setting example: Setting the PV bias screen and PV digital filter screen to no display

The PV bias and PV digital filter screens are set by the F09 block selection (no display) of Engineering mode.

1. In PV/SV monitor, press the \leftarrow R/S key for 4 seconds or more while pressing the (SET) key.
The display goes to the Engineering mode.

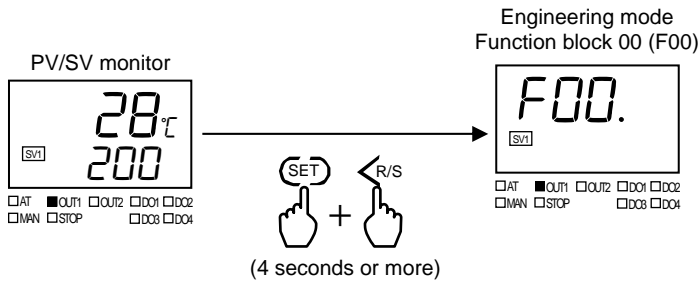

2. Press the \wedge key until Function block 09 (F09) screen is displayed.

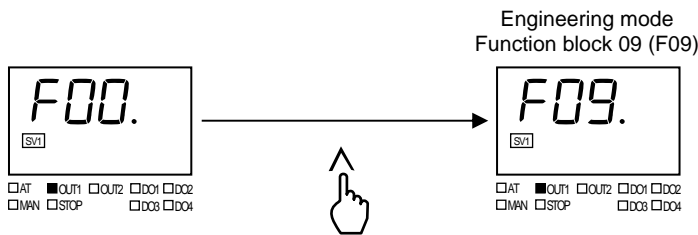

3. Press the (SET) key until F09 block selection (no display) screen is displayed.

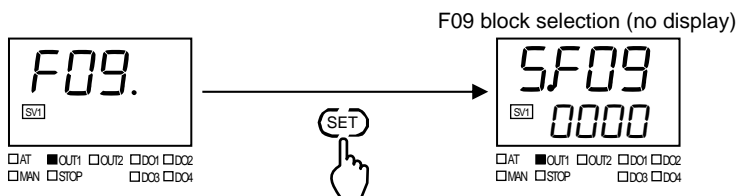

4. Press the \wedge key to change to 1.

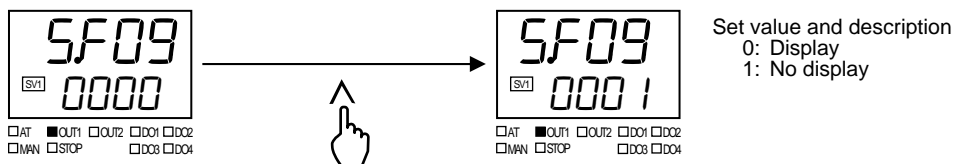

5. Press the (SET) key to store the new value. The display goes to the next parameter.

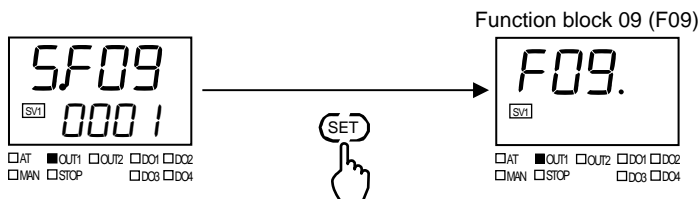

After a new value is displayed on the display by using \wedge and \vee keys, if no key operation is performed within 1 minute without pressing (SET) key, this instrument returns to the Monitor display mode and the set value will not be changed.

■ **Displaying Function block 21 (F21) to Function block 91 (F91) of the Engineering mode**

WARNING

Parameters in the Engineering mode (F21 to F70) should be set according to the application before setting any parameter related to operation. Once the parameters in the Engineering mode are set correctly, no further changes need to be made to parameters for the same application under normal conditions. If they are changed unnecessarily, it may result in malfunction or failure of the instrument. RKC will not bear any responsibility for malfunction or failure as a result of improper changes in the Engineering mode.

1. In PV/SV monitor, press the \leftarrow R/S key for 4 seconds or more while pressing the (SET) key. The display goes to the Engineering mode.

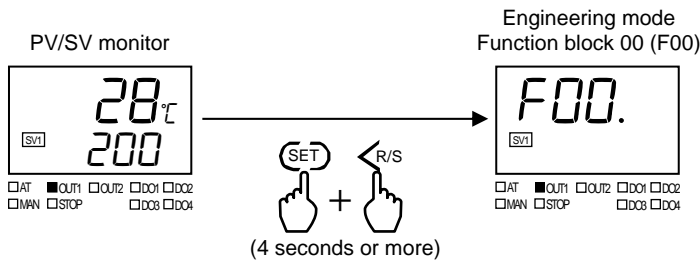

2. Press the (SET) key until Mode selection (no display) screen is displayed.

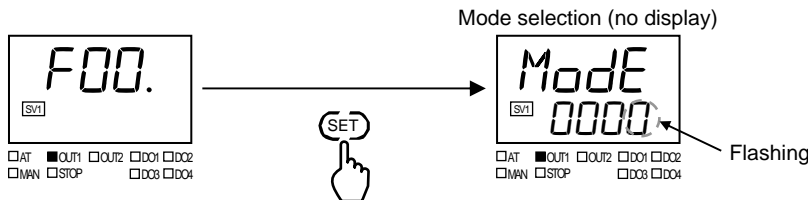

3. Press the \wedge key or \leftarrow R/S key to change to “128.”

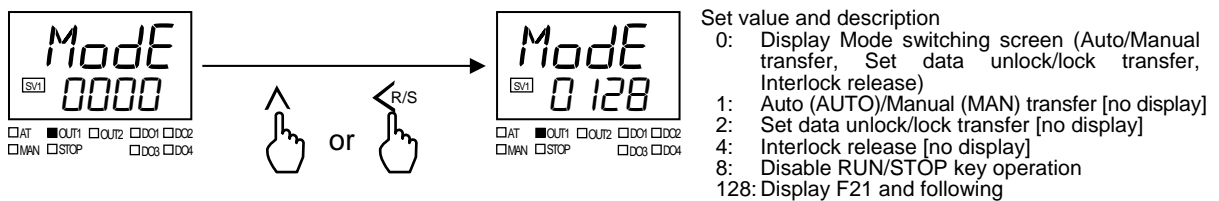

4. Press the (SET) key to store the new value. The display goes to the next parameter.

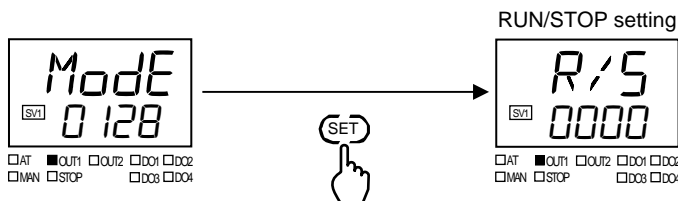

After a new value is displayed on the display by using \wedge and \vee keys, if no key operation is performed within 1 minute without pressing (SET) key, this instrument returns to the Monitor display mode and the set value will not be changed.

6.8 Interlock Release

The interlock action holds the event state even if the measured value is out of the event zone after it enters the event zone once. The interlock release can be made by digital input (DI) [optional], or communication [optional] other than the key operation.

 For the Interlock release by communication, refer to the **Communication Instruction Manual (IMR02C16-E□)**.

 To validate the Interlock function, it is necessary to set Event interlock 1 to 4 (E_IL 1 to 4) to “1: Used” in 8.5 Engineering Mode (P. 8-120).

- The following example shows how the interlock is released.

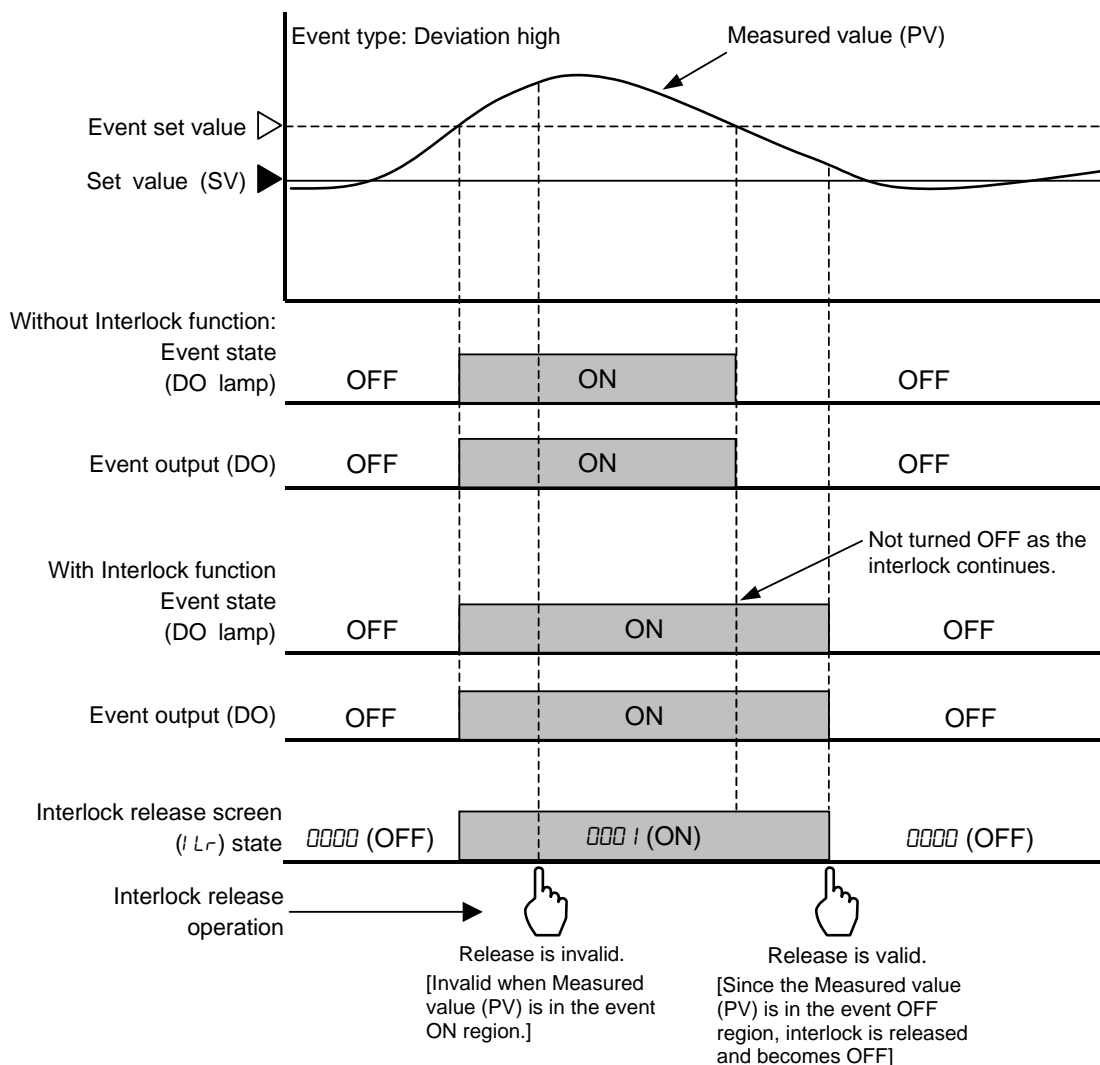

■ Interlock release by front key operation

1. In PV/SV monitor, press the \leftarrow R/S key while pressing the (SET) key.

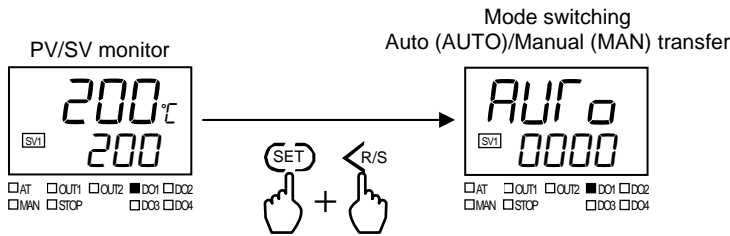

2. Press the (SET) key until Interlock release screen is displayed.

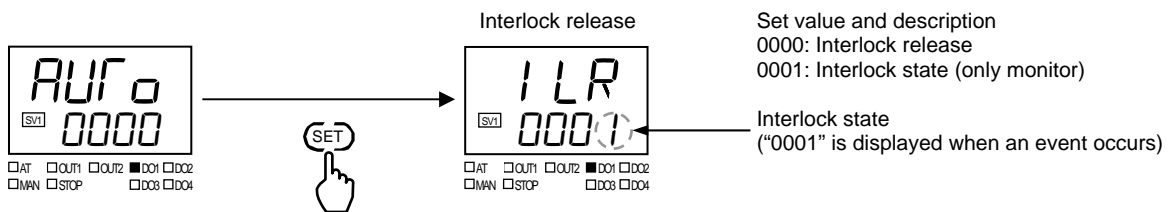

3. Press the V key to release the interlock.

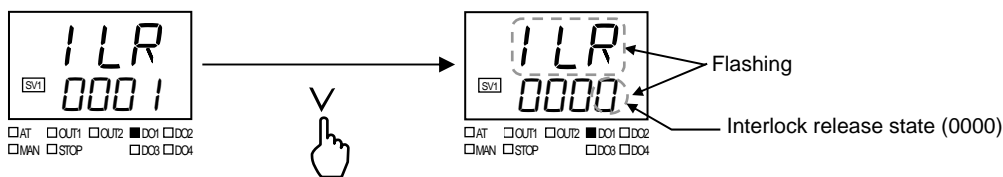

4. Press the (SET) key twice to release the interlock. The display goes to the next parameter.

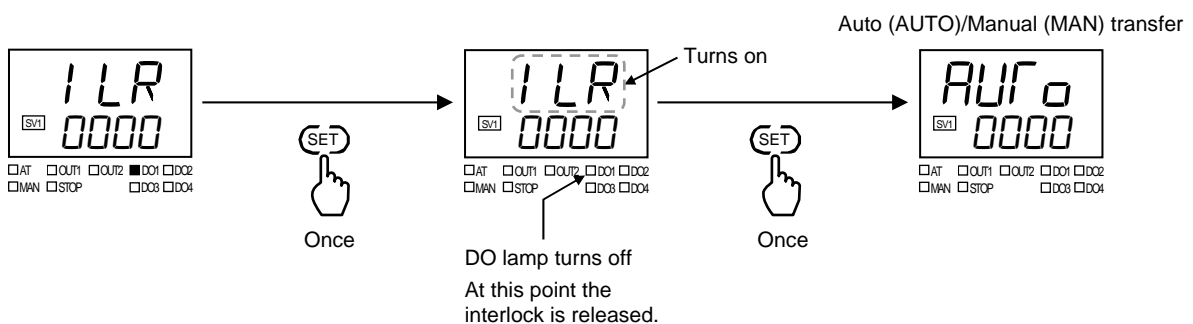

No event interlock can be released when in the event state. Release the event interlock after the cause of the event is cleared up.

■ Interlock release by digital input (DI)

Interlock release by the digital input (DI) is possible with the DI assignment of the Engineering mode.

 For the DI assignment, refer to **8.5 Engineering Mode (P. 8-95)**.

● Terminal configuration

Digital input (DI1, DI2)

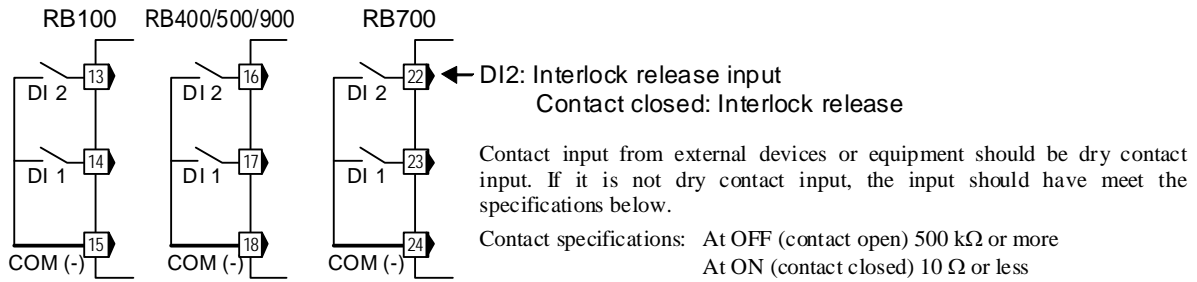

● Transfer timing of Interlock release

The interlock release operation is taken when DI contact is closed from the open condition (rising edge).

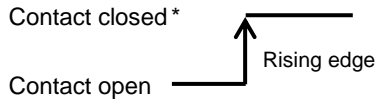

* To make contact activation valid, it is necessary to maintain the same contact state (contact closed) for more than 250 ms.

 **After the contact is closed, it takes “250 ms + 1 sampling cycle *” until the action of this instrument is actually selected.**

* Sampling cycle: 250 ms

 No event interlock can be released when in the event state. Release the event interlock after the cause of the event is cleared up.

 If switched by digital input (DI), the interlock release state is not stored in EEPROM.

MEMO

OPERATING ADDITIONAL FUNCTIONS

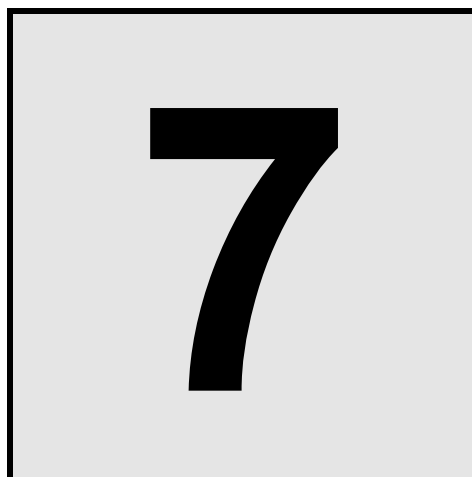

This chapter describes the setting procedure for additional functions.

7.1 SV Selection Function (Step SV function)	7-2
■ Setting procedure	7-2
■ SV selection by front key operation	7-3
■ SV selection by digital input (DI)	7-4
7.2 Timer Function.....	7-5
■ Control start (RUN) by Timer function (Timer function 1).....	7-5
■ Control stop (STOP) by Timer function (Timer function 2).....	7-7
■ Ramp/Soak control (Timer function 3, Timer function 4).....	7-9
7.3 Transmission Output Function.....	7-12
■ Setting procedure	7-12
■ Output calibration	7-13

7.1 SV Selection Function (Step SV function)

The SV selection function enables control by switching to any one of the stored set values of up to four points (SV1 to SV4). The Set value (SV) selecting can be made by digital input (DI) [optional] or communication [optional] other than the key operation.

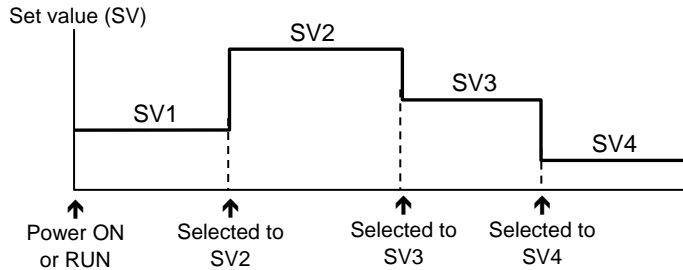

The application of the SV selection function

The SV selection function can be used in combination with the Timer function for ramp/soak control. For Timer function, refer to **7.2 Timer function (P. 7-5)**.

- For SV selection by digital input (DI), refer to **SV selection by digital input (DI) (P. 7-4)**.
- For SV selection by communication, refer to **Communication Instruction Manual (IMR02C16-E□)**.

Setting procedure

The parameter for the SV selection function is not displayed in the factory default setting. Before enabling the function, set "0: Display" in the F01 block selection (no display) (*S.F01*) parameter of Function block 01 (F01) of Engineering mode. For the setting procedure, refer to **Hiding the parameters of the Parameter setting mode (P. 6-37)**.

Before operation, set the Set values 1 (SV1) to 4 (SV4) that are used in SV selection and choose which SV (among SV1 and SV4) will be used to start control.

Press and hold the **(SET)** key for 2 seconds or more at the PV/SV monitor screen to go to the Parameter setting mode and set the control set value in the screen of SV1 to SV4.

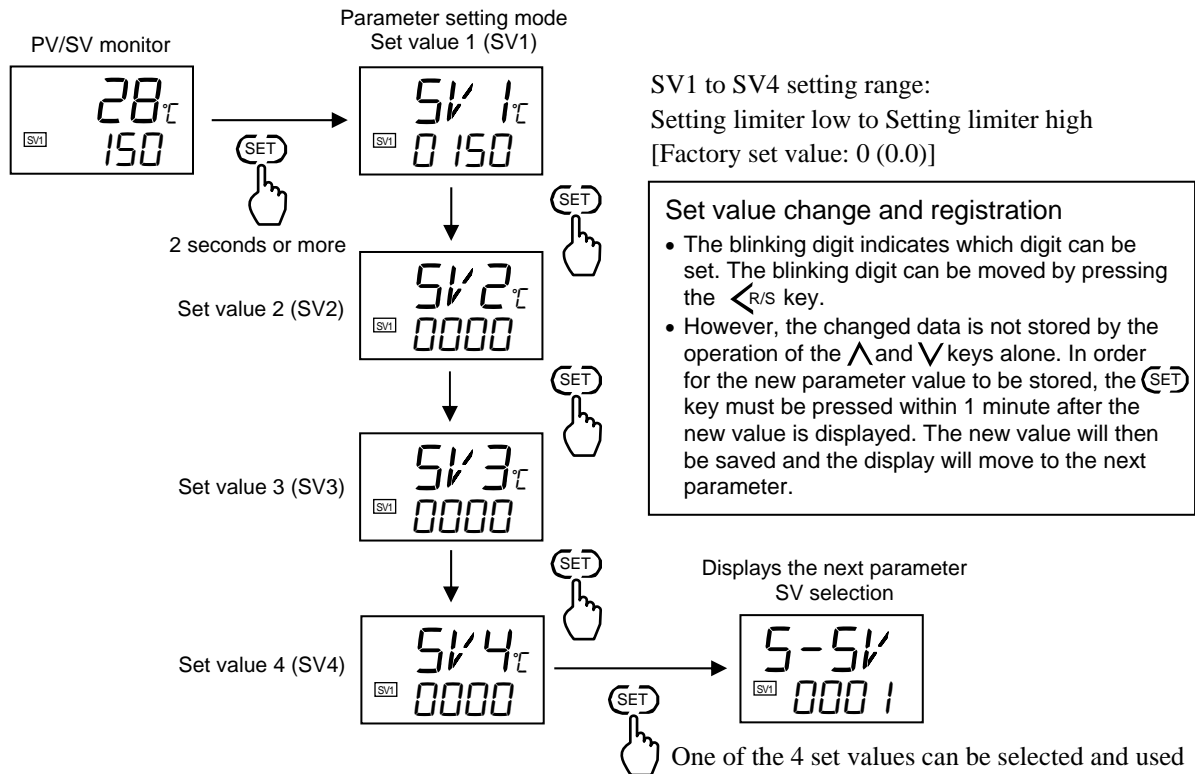

Return to the PV/SV monitor

To return the PV/SV monitor, press and hold the **(SET)** key for 2 seconds or more.

One of the 4 set values can be selected and used for control. [Factory set value: 1 (SV1)]
 For SV selection method, refer to **SV selection by front key operation (P. 7-3)** or **SV selection by digital input (DI) (P. 7-4)**.

■ SV selection by front key operation

To switch to SV1 to SV4 by front key operation, use the SV selection parameter of Parameter setting mode.

 If Timer function 3 or Timer function 4 is in use, it will not be possible to switch SV (among SV1 and SV4) by front key operation.

[Example: Switching from SV1 to SV2]

1. Press and hold the **(SET)** key for 2 seconds or more at the PV/SV monitor screen to go to the Parameter setting mode, and press the **(SET)** key to display to the SV selection screen.

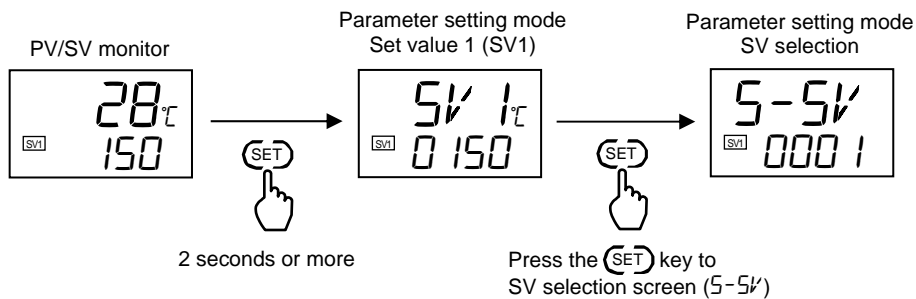

2. Change the value of the flashing digit to “2” with the **^** key. Press the **(SET)** key to store the new value.

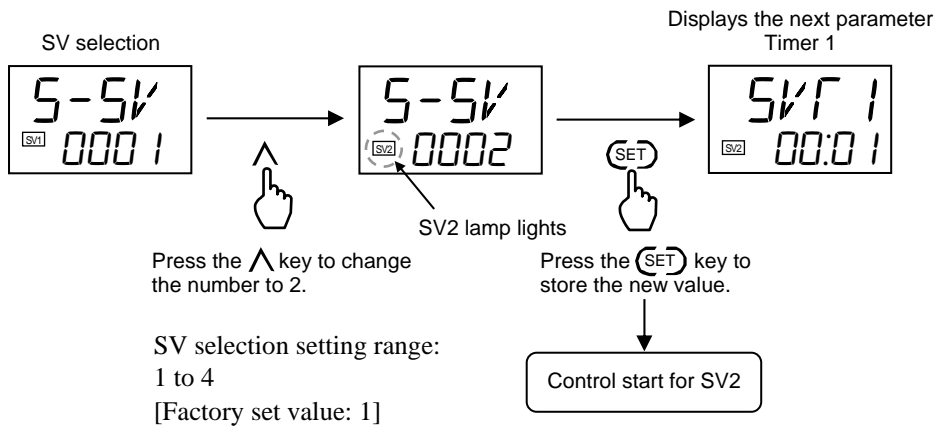

• Return to the PV/SV monitor

To return the PV/SV monitor, press and hold the **(SET)** key for 2 seconds or more.

 After a new value is displayed on the display by using **^** and **v** keys, if no key operation is performed within 1 minute without pressing **(SET)** key, this instrument returns to the PV/SV monitor screen and the set value will not be changed.

■ **SV selection by digital input (DI)**

To switch to SV1 to SV4 using digital input (DI) [optional], assign the SV selection function in the DI assignment parameter of Engineering mode before operation.

- 📖 If Timer function 3 or Timer function 4 is in use, it will not be possible to switch SV (among SV1 and SV4) by digital input (DI).
- 👉 For the DI assignment, refer to **8.5 Engineering Mode (P. 8-95)**.

● **Terminal Configuration**

Digital input (DI1 and DI2)

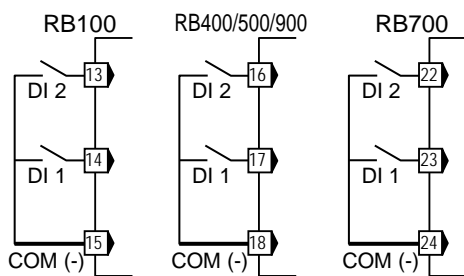

Select SV from SV1 to SV4 using the combination of DI1 and DI2.

	OFF (contact open)		ON (contact closed)	
	SV1	SV2	SV3	SV4
DI1	OFF	ON	OFF	ON
DI2	OFF	OFF	ON	ON

Contact input from external devices or equipment should be dry contact input.

Contact specification: At OFF (contact open) 500 kΩ or more
At ON (contact closed) 10 Ω or less

● **SV switchover timing**

2 seconds after the DI1 or DI2 contact changes, the SV change will take place.

[Example: Switching from SV1 to SV2, then to SV3]

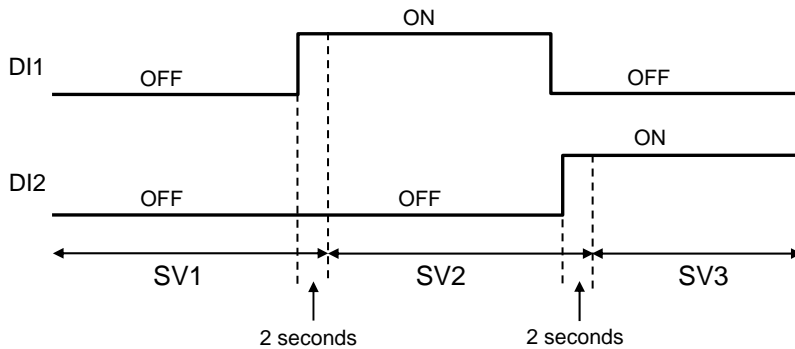

📖 **When two-point switchover between SV1 and SV2 is selected in the SV selection function of the DI assignment parameter, the timing of SV switchover is as shown below.**

SV switchover takes place “250 ms + 1 sampling cycle *” after the DI1 contact changes.

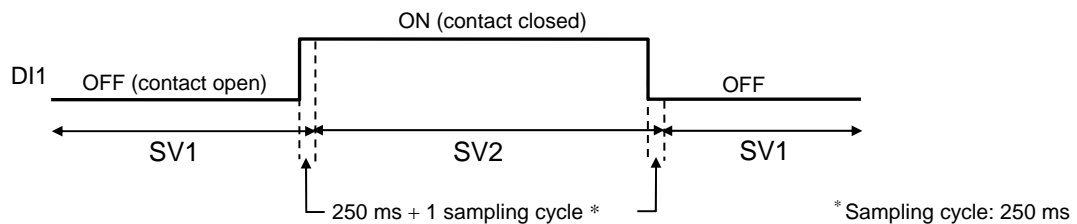

7.2 Timer Function

Parameters related to the Timer function are set to “not displayed” in the factory default setting. Before using the parameters, set “0: Display” in the F02 block selection (no display) [5. F02] parameter of Function block 02 (F02) and the F03 block selection (no display) [5. F03] parameter of Function block 03 (F03) in Engineering mode.

For the setting procedure, refer to ■ **Hiding the parameters of the Parameter setting mode (P. 6-37)**.

■ Control start (RUN) by Timer function (Timer function 1)

Timer function 1 can be used to start control using the Set value (SV) selected by the SV selection parameter after the timer time elapses.

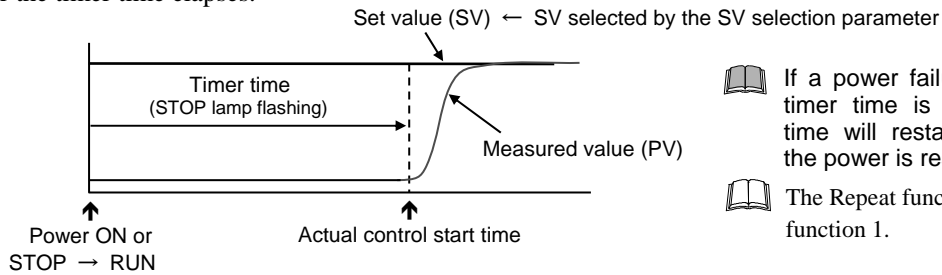

If a power failure occurs while the timer time is elapsing, the Timer time will restart from 00:00 when the power is restored.

The Repeat function is not used in Timer function 1.

● Timer setting

Before operation, set the Set value (SV) selection used in the Timer function, the Timer function selection, and the Timer time.

[Example: Timer 1 starts control using Set value 1 (SV1) 10 minutes after transfer to RUN]

- In the PV/SV monitor state, press and hold the **(SET)** key for 2 seconds or more to switch to Parameter setting mode, and then select the setting for the control set value of SV1 and select SV1 in the SV selection parameter.

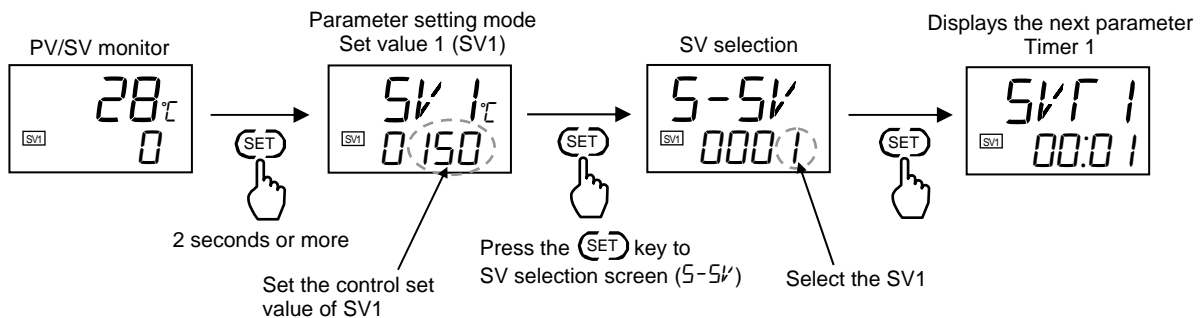

- Set the Timer time to “10:00” in the Timer 1 parameter. Press the **(SET)** key to move to the Timer function selection parameter, and set “1 (Timer function 1).”

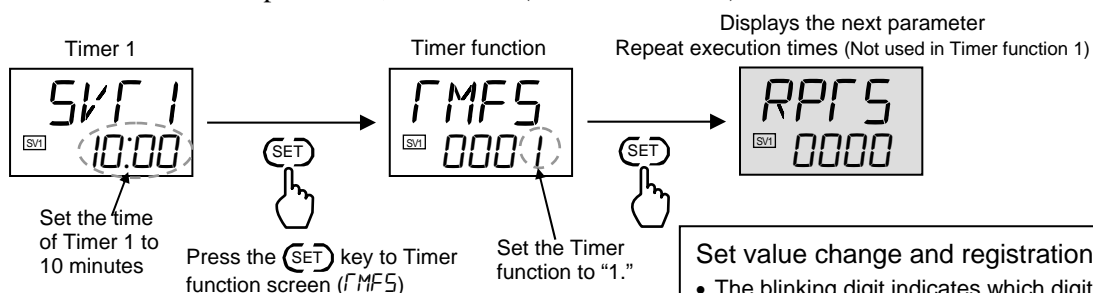

Timer time setting range:

00 minute 01 seconds to 99 minutes 59 seconds or
00 hour 01 minutes to 99 hours 59 minutes

[Factory set value: 00 minute 01 seconds]

The Timer time unit is selected by the Timer time unit parameter of Engineering mode. (min.: sec. or hour: min.)

[Factory set value of time unit of timer: 0 (min.: sec.)]

● Return to the PV/SV monitor

To return the PV/SV monitor, press and hold the **(SET)** key for 2 seconds or more.

Set value change and registration

- The blinking digit indicates which digit can be set. The blinking digit can be moved by pressing the **(R/S)** key.
- However, the changed data is not stored by the operation of the **(^)** and **(v)** keys alone. In order for the new parameter value to be stored, the **(SET)** key must be pressed within 1 minute after the new value is displayed. The new value will then be saved and the display will move to the next parameter.

● **Timer start**

When the settings for the Timer function 1 are finished, start the timer.

In the STOP state, press and hold the \leftarrow R/S key for 2 seconds or more to start the timer. When the set timer time elapses, the state changes to RUN and control starts.

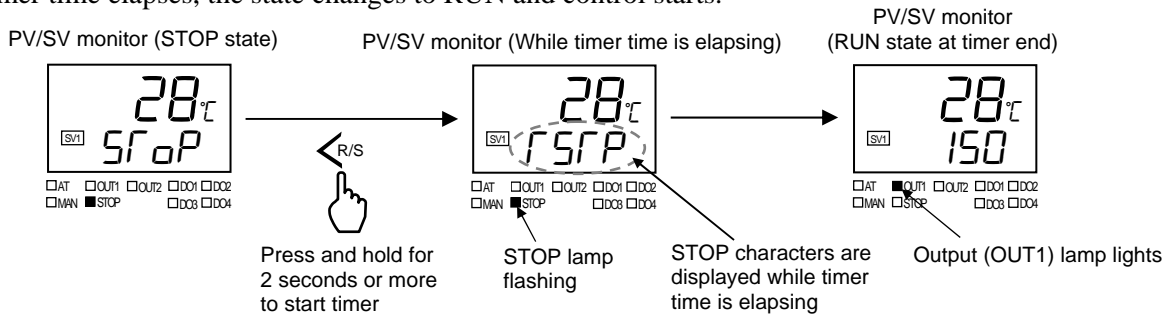

In addition to starting the timer by front key operation, digital input (DI) [optional] or communication [optional] can also be used to start the timer at transfer from STOP to RUN.

● **Remaining time monitor**

While timer time is elapsing, the Remaining timer time can be monitored.

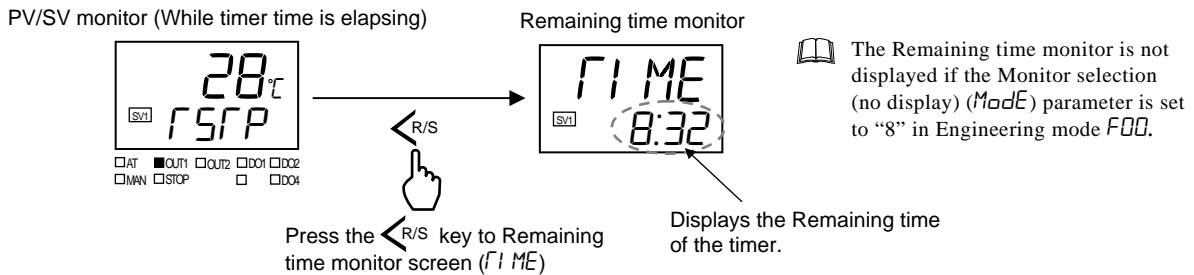

● **Ramping the Set value (SV)**

The Setting change rate limiter (up) parameter can be enabled to ramp the Set value (SV) up a fixed ramp from the start point of control.

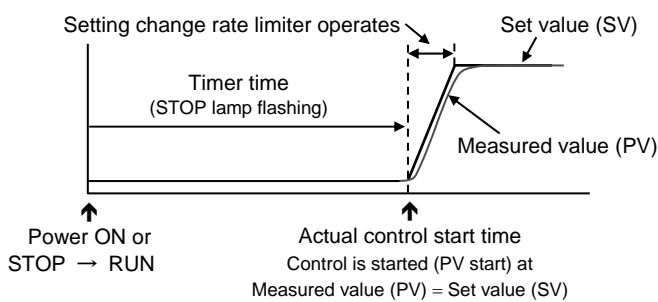

Setting change rate limiter (up/down) setting range:

1 (0.1) to Input span (Unit: °C [°F])/unit time (0: Unused)

[Factory set value: 0 (0.0)]

The unit time is selected in the Setting change rate limiter unit time parameter of Engineering mode. (minutes or hours)

[Factory set value of unit time: 0 (minute)]

In the PV/SV monitor state, press and hold the SET key for 2 seconds or more to switch to Parameter setting mode and set the change rate in the Setting change rate limiter (up) parameter.

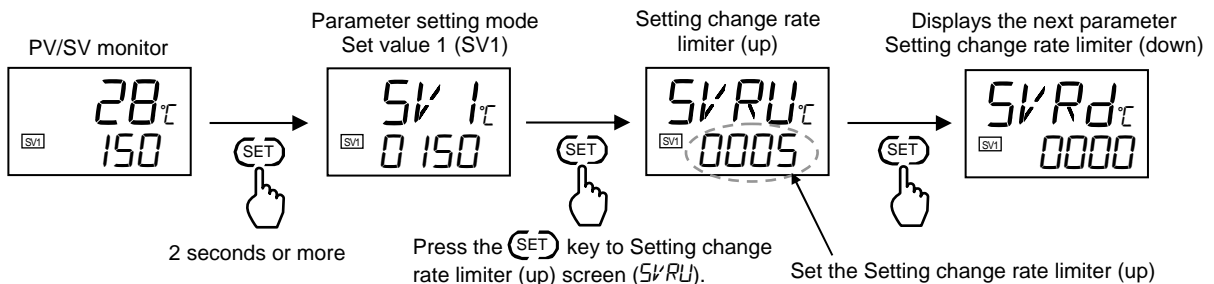

■ Control stop (STOP) by Timer function (Timer function2)

Using the Set value (SV) selected in the SV selection parameter, Timer function 2 stops control when the timer time elapses.

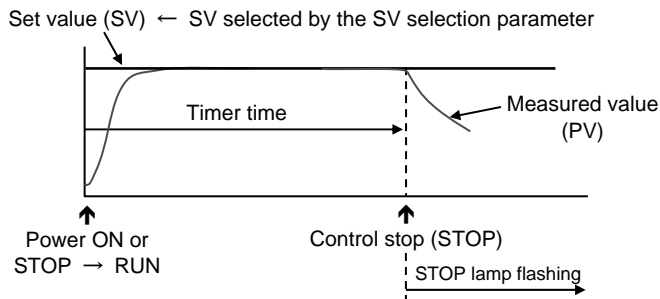

If a power failure occurs while the timer time is elapsing, the Timer time will restart from 00:00 when the power is restored.

The repeat function is not used in Timer function 2.

● Timer setting

Before operation, set the Set value (SV) selection used in the Timer function, the Timer function selection, and the Timer time.

[Example: Stopping control using Set value 1 (SV1) when 60 minutes elapses on Timer 1 after switching to RUN]

- In the PV/SV monitor state, press and hold the **(SET)** key for 2 seconds or more to switch to Parameter setting mode, and then select the setting for the control set value of SV1 and select SV1 in the SV selection parameter.

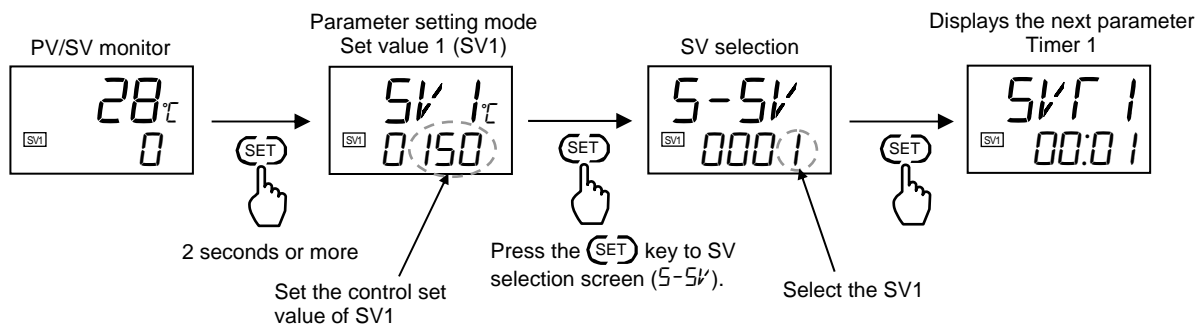

- Set the Timer time to "60:00" in the Timer 1 parameter. Press the **(SET)** key to move to the Timer function selection parameter, and set "2 (Timer function 2)."

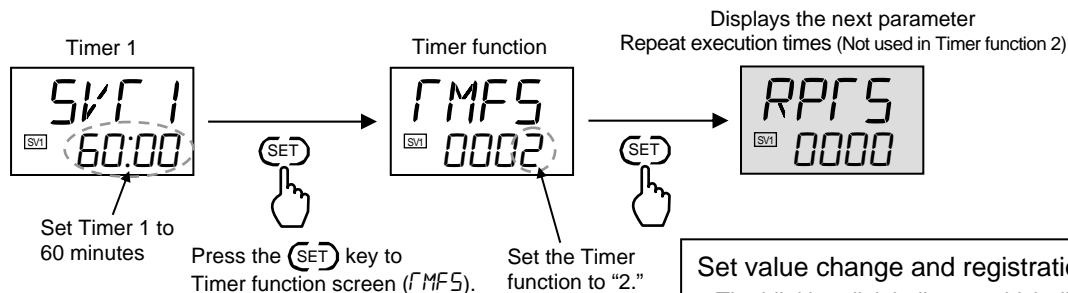

Timer time setting range:

00 minute 01 seconds to 99 minutes 59 seconds or
00 hour 01 minutes to 99 hours 59 minutes

[Factory set value: 00 minute 01 seconds]

The Timer time unit is selected by the Timer time unit parameter of Engineering mode. (min.: sec. or hour: min.)

[Factory set value of time unit of timer: 0 (min.: sec.)]

● Return to the PV/SV monitor

To return the PV/SV monitor, press and hold the **(SET)** key for 2 seconds or more.

Set value change and registration

- The blinking digit indicates which digit can be set. The blinking digit can be moved by pressing the **←/→** key.
- However, the changed data is not stored by the operation of the **▲** and **▼** keys alone. In order for the new parameter value to be stored, the **(SET)** key must be pressed within 1 minute after the new value is displayed. The new value will then be saved and the display will move to the next parameter.

● **Timer start**

When the settings for the Timer function 2 are finished, start the timer.

In the STOP state, press and hold the <R/S> key for 2 seconds or more to switch to RUN (control RUN). The timer starts, and when the set timer time elapses, the state changes to STOP and control is stopped.

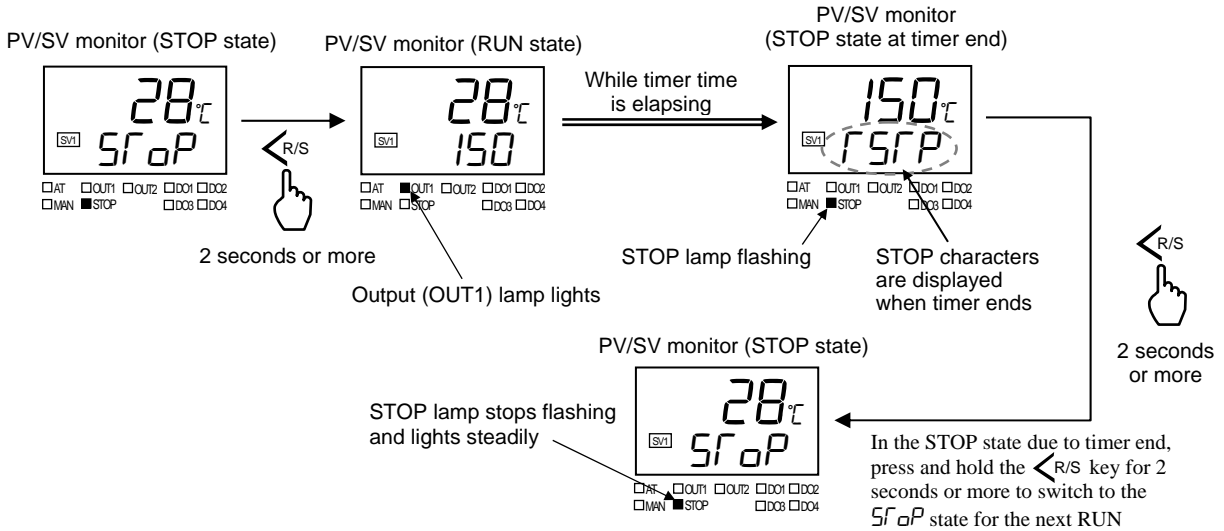

In addition to starting the timer by front key operation, digital input (DI) [optional] or communication [optional] can also be used to start the timer at transfer from STOP to RUN.

● **Remaining time monitor**

While timer time is elapsing, the remaining timer time can be monitored.

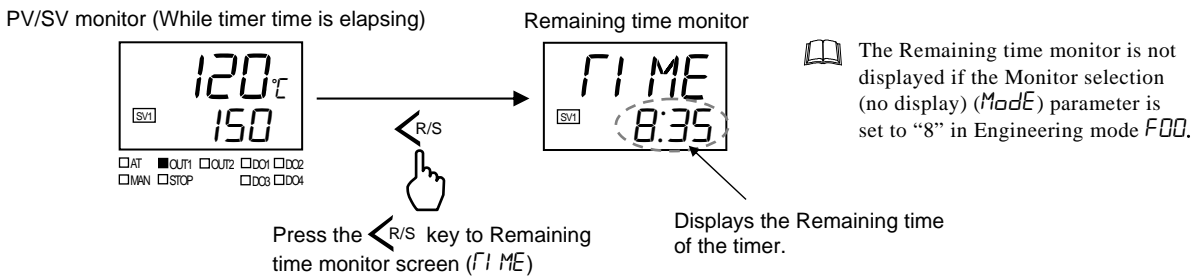

● **Timer operation when Setting change rate limiter (up) is enabled**

When the Setting change rate limiter (up) parameter is enabled, timer operation starts when Setting change rate limiter operation ends.

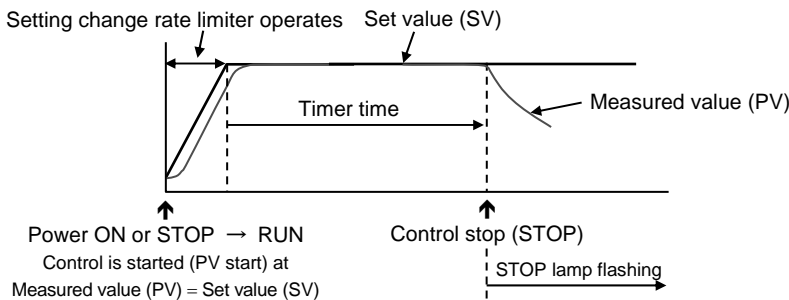

For the procedure for enabling Setting change rate limiter (up), refer to ● **Ramping the set value (SV) in ■ Control start (RUN) by Timer function (Timer function 1) (P. 7-6).**

■ Ramp/Soak control (Timer function 3, Timer function 4)

Timer function 3 and Timer function 4 can be used to link Set values 1 to 4 (SV1 to SV4) for ramp/soak control. In addition, the repeat function can be used to execute repeated ramp/soak control.

📖 If a power failure occurs while the timer time is elapsing, restart will take place from SV1 (Timer time 00:00) when the power is restored.

● Action of Timer function 3 and Timer function 4

When the power is turned on or STOP is switched to RUN, control always starts from Set value 1 (SV1) and ends at Set value 4 (SV4).

📖 SV selection is invalid in Timer function 3 and Timer function 4.

Timer function 3: After the timer time of Set value 4 (SV4) elapses, control continues using SV4.

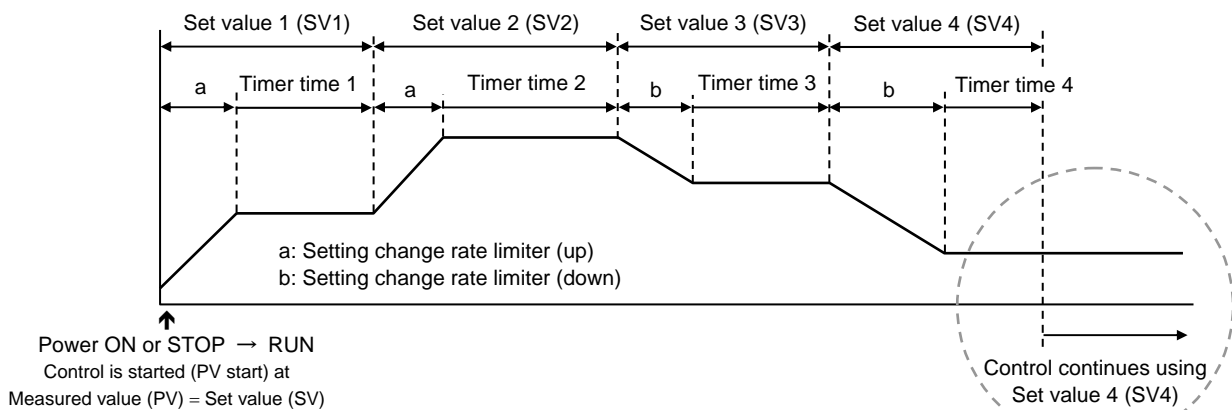

Timer function 4: After the timer time of Set value 4 (SV4) elapses, control stops.

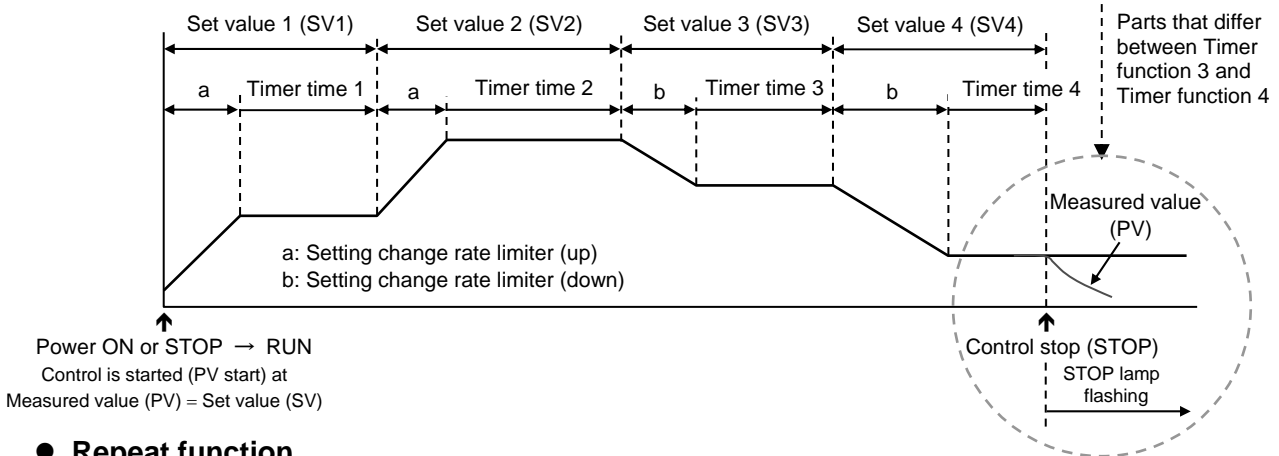

● Repeat function

The Repeat function can only be used with Timer function 3 and Timer function 4.

[Example: When the Repeat execution times is set to two]

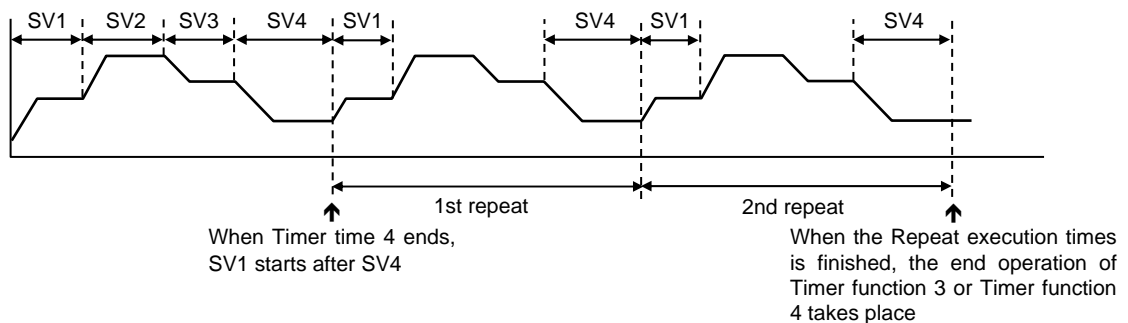

● **Timer setting**

The parameters below must be set for Timer function 3 and Timer function 4 in Parameter setting mode before operation.

- Set value 1 (SV1) to Set value 4 (SV4)
- Timer time 1 (Timer 1) to Timer time 4 (Timer 4)
- Timer function
- Repeat execution times (only set if the Repeat function will be used)
- Setting change rate limiter (up/down) (not necessary if the set values will be changed by steps)

Example:

	SV1	SV2	SV3	SV4
Set value	100 °C	200 °C	150 °C	50 °C
Timer time	40 min.	90 min.	60 min.	30 min.
Timer function	4 (Timer function 4)			
Repeat execution times	2			
Setting change rate limiter (up)	10 °C/min.			
Setting change rate limiter (down)	5 °C/min.			

Timer time setting range:

00 minute 01 seconds to 99 minutes 59 seconds or
00 hour 01 minutes to 99 hours 59 minutes

Repeat execution times setting range:
0 to 9999 (9999: Infinite times)

Setting change rate limiter (up/down) setting range:
1 (0.1) to Input span (Unit: °C [°F])/unit time



The time units of the Timer time and Setting change rate limiters can be changed in Timer time unit (FMU) and Setting change rate limiter unit time (SVRF) in Function block 70 (F70) of Engineering mode.

In the PV/SV monitor state, press and hold the (SET) key for 2 seconds or more to switch to Parameter setting mode and set each parameter in the setting examples.

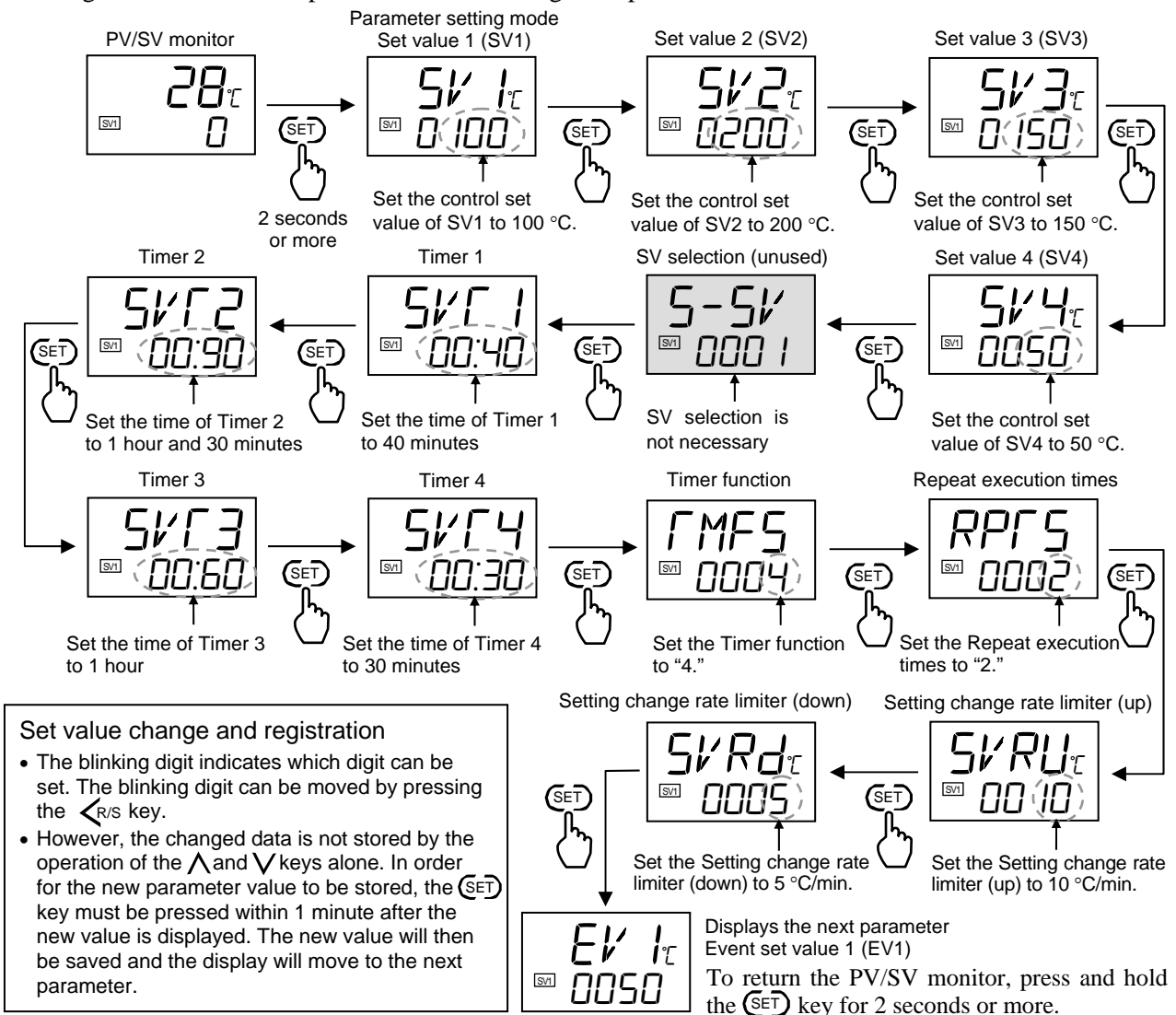

● **Timer start**

When the settings of Timer function 3 and Timer function 4 are completed, start the timer.

Timer function 3:

In the STOP state, press and hold the \leftarrow R/S key for 2 seconds or more to switch to RUN (start control). During the set Timer time, control takes place from Set value 1 (SV1) to Set value 4 (SV4), and after the timer time of SV4 ends, control continues using SV4.

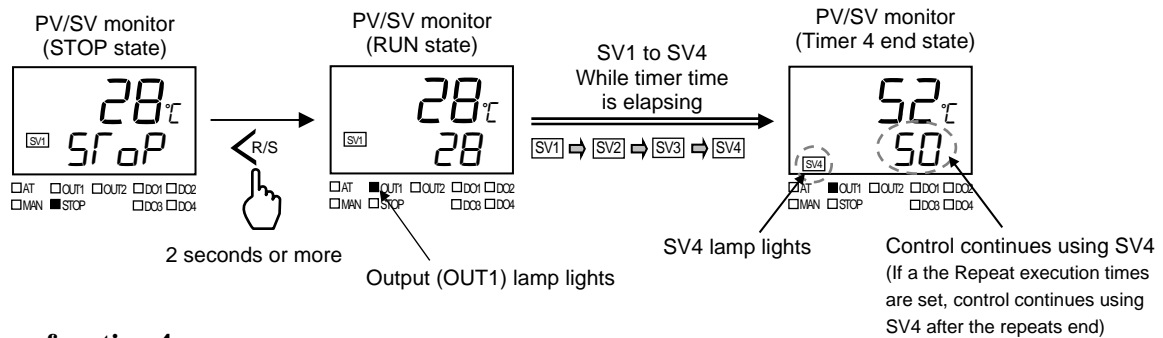

Timer function 4:

In the STOP state, press and hold the \leftarrow R/S key for 2 seconds or more to switch to RUN (control RUN). During the set timer time, control takes place from Set value 1 (SV1) to Set value 4 (SV4), and after the timer time of SV4 ends, control stops.

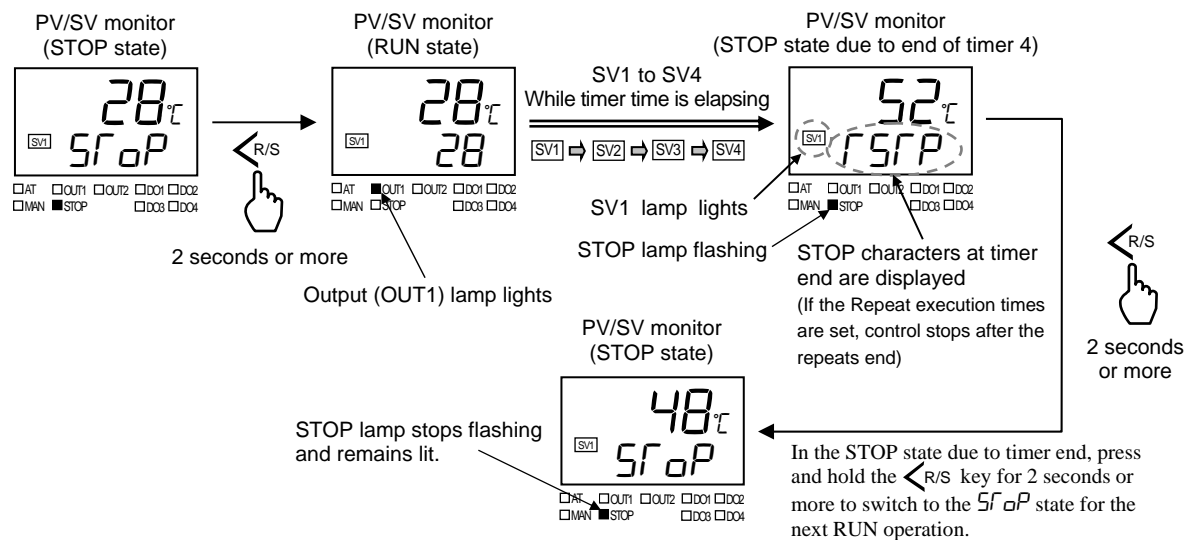

In addition to starting the timer by front key operation, digital input (DI) [optional] or communication [optional] can also be used to start the timer at transfer from STOP to RUN.



After the timer starts, switching to STOP stops the timer. When you switch to RUN again, restart takes place from SV1.

● **Remaining time monitor**

While timer time is elapsing, the remaining timer time can be monitored.

PV/SV monitor (While timer time is elapsing)

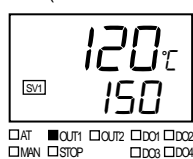

Remaining time monitor

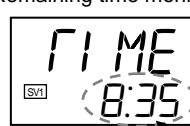

The Remaining time monitor is not displayed if the Monitor selection (no display) (*ModE*) parameter is set to "8" in Engineering mode *F00*.

Press the \leftarrow R/S key to Remaining time monitor screen (71 ME).

Displays the remaining time of the timer.

7.3 Transmission Output Function

The Transmission output function (optional) is outputting the state of Measured value (PV), Set value (SV), or Manipulated output value (MV1) as a voltage or current signal. It is possible to record the state of Measured value (PV) or Set value (SV) when connected to a recorder.

Terminal configuration

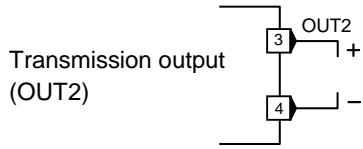

Output signal type (Specify when ordering)

Voltage output	0 to 5 V DC, 0 to 10 V DC, 1 to 5 V DC
Current output	0 to 20 mA DC, 4 to 20 mA DC



The Transmission output function can only be used if the control action is specified as PID action (direct or reverse) when the order is placed.

Setting procedure

If the Transmission output function will be used, set the following parameters in Engineering mode:

- Transmission output type
 - Transmission output scale high
 - Transmission output scale low
 - AO full scale adjustment value *
 - AO zero adjustment value *
- Settings are configured in the STOP (control STOP) state.*

* Do not change the factory set adjustment value for the AO full scale adjustment value and or the AO zero adjustment value as the accuracy will be changed.

The Transmission output function parameters are set to "not displayed" in the factory default setting. Before configuring the parameters, display the parameters by setting the Mode selection (no display) [ModE] parameter to "128" in Function block 00 (F00) of Engineering mode. For the setting procedure, refer to **5.1 Initial Setting (P. 5-3)**.

[Example: Scaling the Measured value (PV) to 50 to 250 °C before output (Output signal: 4 to 20 mA DC)]

In PV/SV monitor (the STOP state), press and hold the **SET** key and **←R/S** key for 4 seconds or more to switch to Engineering mode and set each parameter in the **F33** parameter group.

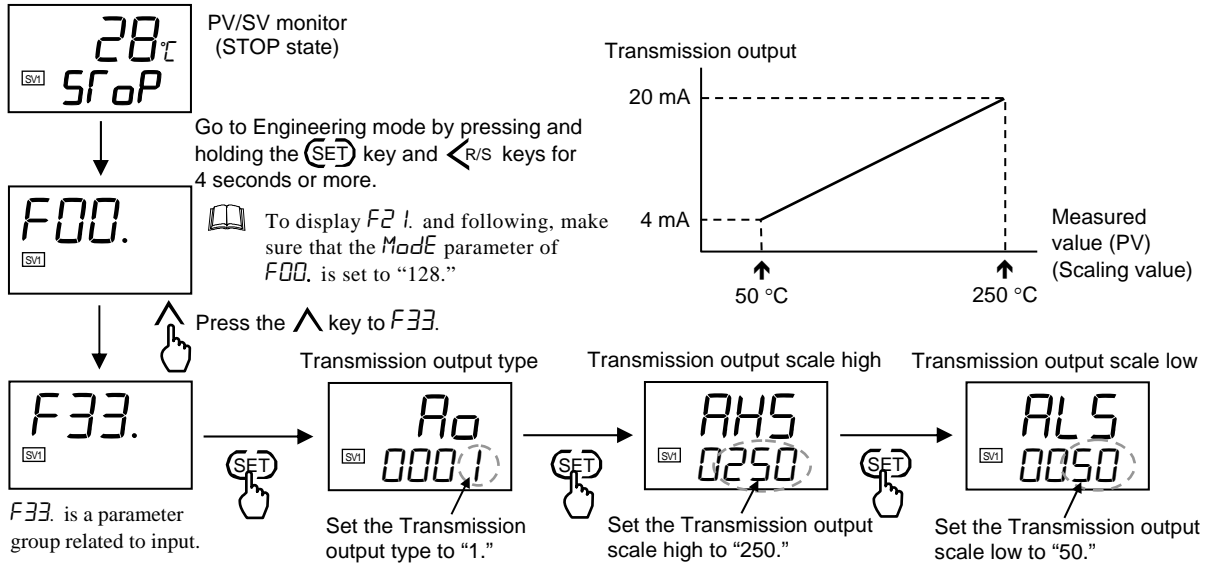

Transmission output type: Transmission output scale high/low setting range:

- 0: Manipulated output value (MV1)
 - 1: Measured value (PV)
 - 2: Set value (SV)
- [Factory set value:
1: Measured value (PV)]

	Transmission output scale high	Transmission output scale low
When Measured value (PV) or Set value (SV) is selected	Transmission output scale low to Input scale high	Input scale low to Transmission output scale high
When Manipulated output value (MV1) is selected	Transmission output scale low to +105.0 %	-5.0 % to Transmission output scale high
Factory set value	High-limit value of input span	Low-limit value of input span

Set value change and registration

- The blinking digit indicates which digit can be set. The blinking digit can be moved by pressing the **←R/S** key.
- However, the changed data is not stored by the operation of the **^** and **∨** keys alone. In order for the new parameter value to be stored, the **SET** key must be pressed within 1 minute after the new value is displayed. The new value will then be saved and the display will move to the next parameter.

■ Output calibration

The AO full scale adjustment value and AO zero adjustment value of Transmission output can be adjusted within the range -10.0 to $+10.0$ %.

 **Do not change the factory set adjustment value for the AO full scale adjustment value and or the AO zero adjustment value as the accuracy will be changed.**
(Transmission output accuracy: ± 0.3 % of span)

 The AO full scale adjustment value and AO zero adjustment value can be set in Engineering mode even in the RUN state.

[Example: When full scale is adjustment to the $+10.0$ %]

In the PV/SV monitor state, press and hold the **(SET)** key and **<R/S** key for 4 seconds or more to go to Engineering mode and set the AO full scale adjustment value in the *F33*. parameter group.

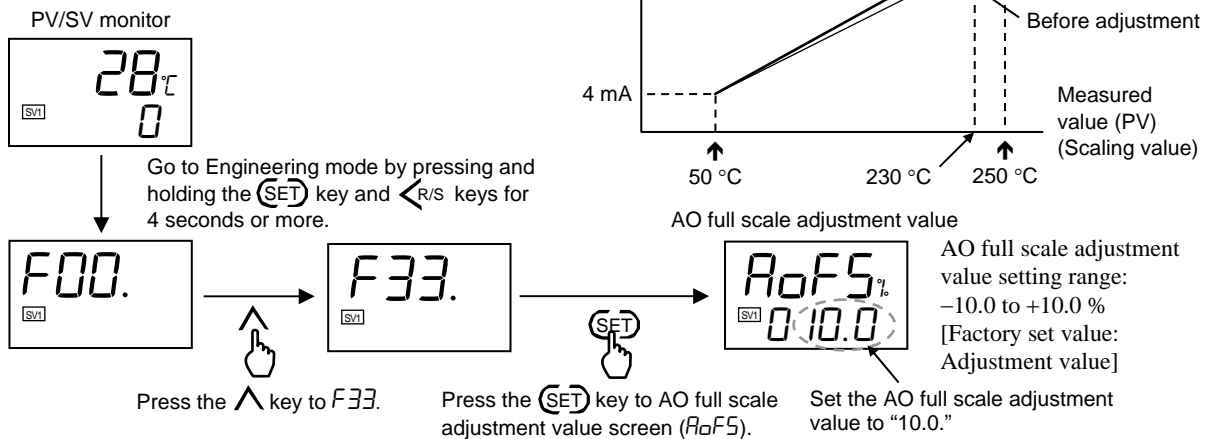

 To display *F2 l.* and following, make sure that the *ModE* parameter of *F00*. is set to "128."

[Example: When zero point is adjustment to the $+5.0$ %]

In the PV/SV monitor state, press and hold the **(SET)** key and the **<R/S** key for 4 seconds or more to go to Engineering mode and set the AO zero adjustment value in the *F33*. parameter group.

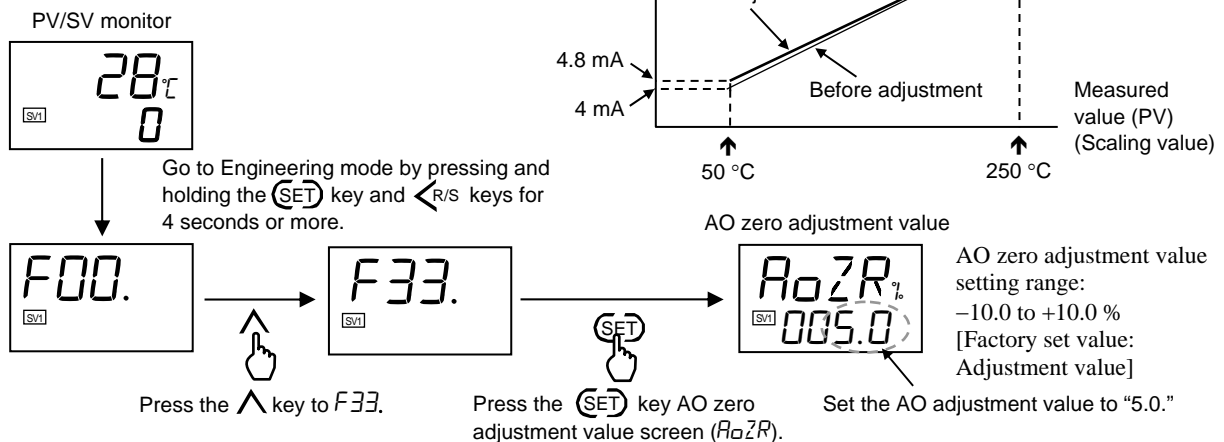

 To display *F2 l.* and following, make sure that the *ModE* parameter of *F00*. is set to "128."

• Return to the PV/SV monitor

To return the PV/SV monitor, press and hold the **(SET)** key for 2 seconds or more.

MEMO

PARAMETER DESCRIPTION

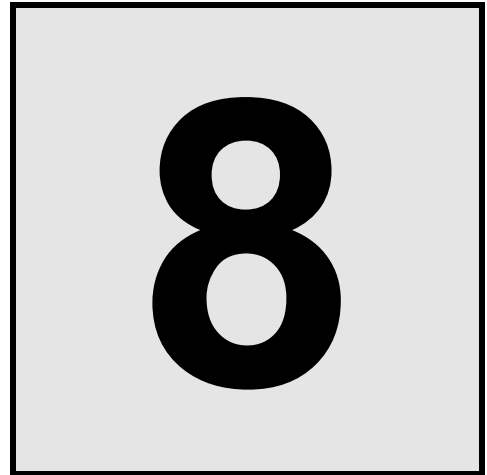

This chapter describes of each parameters and data range.

8.1 Monitor Display Mode	8-2
8.2 SV Setting Mode.....	8-6
8.3 Mode Switching	8-9
8.4 Parameter Setting Mode.....	8-12
8.5 Engineering Mode.....	8-43

8.1 Monitor Display Mode

In Monitor display mode, the following monitors are possible.

- Measured value (PV)/Set value (SV) monitor
- Current transformer 1 (CT1) input value monitor
- Current transformer 2 (CT2) input value monitor
- Manipulated output value (MV1) monitor [heat-side]
- Manipulated output value (MV2) monitor [cool-side]
- Remaining time timer

The following parameters can also be set to no display:

- Current transformer 1 (CT1) input value monitor
- Current transformer 2 (CT2) input value monitor
- Manipulated output value (MV1) monitor [heat-side]
- Manipulated output value (MV2) monitor [cool-side]
- Remaining time monitor

Set display/no display at the Monitor selection in the Function block F00 in the Engineering mode (P. 8-58).

8.1.1 Display sequence

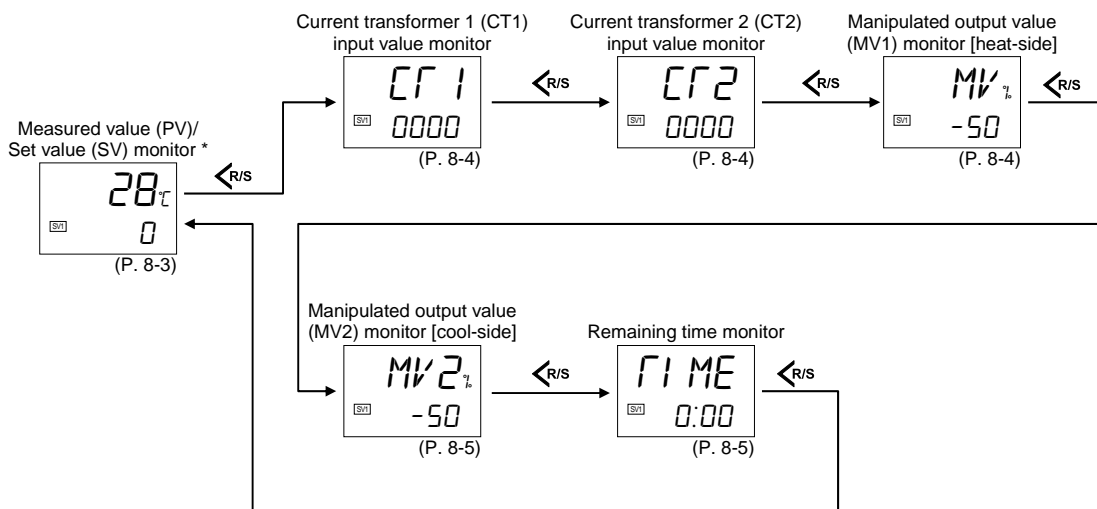

* PV/SV monitor



Parameters will not be displayed if the relevant function is not activated or no relevant specification is selected when ordering.

8.1.2 Monitor item

Measured value (PV)/Set value (SV) monitor

PV display

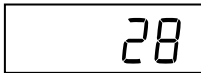

SV display

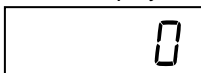

Measured value (PV) display (hereafter called PV display):

The Measured value (PV) is displayed.

Set value (SV) display (hereafter called SV display):

The target value for control is displayed. The value to be displayed varies depending on the state of operation mode.

- Set value (SV)* is displayed when the operation mode is Auto (AUTO) mode.

* With the setting change rate limiter when the set value is changed, the displayed set value changes according to the ramp-up/down rate.

- Manipulated output value (MV) is displayed when the operation mode is Manual (MAN) mode.

Display or Data range	Factory set value
Measured value (PV): Input scale low to Input scale high	—
Set value (SV): Setting limiter low to Setting limiter high	—
Manipulated output value (MV1 or MV2): PID control: Output limiter low to Output limiter high (-5.0 to +105.0 %) Heat/Cool PID control: -Cool-side output limiter (high) to +Heat-side output limiter (high) (-105.0 to +105.0 %)	—

 In the STOP mode, displays the “5rOP” character on the PV or SV display. Display position of “5rOP” can be set in the Engineering mode (P. 8-97).

 When Heat/Cool PID control is performed, it is necessary to select Output 2 (OUT2) when ordering.

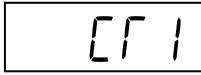

Current transformer 1 (CT1) input value monitor Current transformer 2 (CT2) input value monitor



The current value captured by the current transformer (CT) is displayed on the SV display.



Display range	Factory set value
When CT type is CTL-6-P-N: 0.0 to 30.0 A	—
When CT type is CTL-12-S56-10L-N: 0.0 to 100.0 A	—

-  When the current transformer (CT) input is provided, the Current transformer 1 (CT1) input value monitor is displayed.
-  Current transformer 2 (CT2) displays when 2 points are specified for the current transformer input.
-  To hide Current transformer 1 (CT1) input value monitor and Current transformer 2 (CT2) input value, set “No display” to Monitor selection (P. 8-58) in the Engineering mode.

Related parameters

Engineering mode:

- Monitor selection (no display) (P. 8-58)

Manipulated output value (MV1) monitor [heat-side]

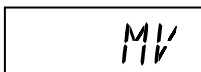

The Manipulated output value (MV1) is displayed on the SV display.
When the control method is Heat/Cool PID action, the Manipulated output value (MV1) of heat-side is displayed.

Display range	Factory set value
Within output limiter range	—

-  To hide Manipulated output value (MV1) monitor [heat-side], set “No display” to Monitor selection (no display) in the Engineering mode (P. 8-58).

Related parameters

Engineering mode:

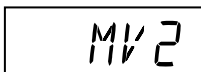

- Monitor selection (no display) (P. 8-58)

Manipulated output value (MV2) monitor [cool-side]



The Manipulated output value (MV2) of cool-side is displayed on the SV display.

Display range	Factory set value
Within output limiter range	—

-  When the control method is Heat/Cool PID action, the Manipulated output value (MV2) monitor is displayed.
-  To hide Manipulated output value (MV2) monitor [cool-side], set “No display” to Monitor selection (no display) in the Engineering mode (P. 8-58).

Related parameters

Engineering mode:

- Monitor selection (no display) (P. 8-58)

Remaining time monitor

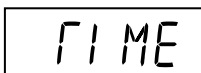

Displays the elapsed time of timer operation.

Timer function 1:

Shows the time remaining in RUN (control RUN) during the timer time operation.

Timer function 2:

Shows the time remaining in STOP (control STOP) during the timer time operation.

Timer function 3 and Timer function 4:

Shows each time remaining in the order of Set values from SV1, SV2, SV3, and SV4 during the timer time operation.

Display range	Factory set value
0 minutes 00 seconds to 99 minutes 59 seconds or 0 hours 00 minutes to 99 hours 59 minutes	—

-  The factory preset is “Min.: Sec.”.

Related parameters

Engineering mode:

- Monitor selection (no display) (P. 8-58)

8.2 SV Setting Mode

The SV setting mode is used to sets the Set value (SV) or Manipulated output value (MV).

- When the operation mode is the Auto (AUTO) mode, the Set value (SV) can be set.
- When the operation mode is the Manual (MAN) mode, the Manipulated output value (MV) can be set.

8.2.1 Display sequence

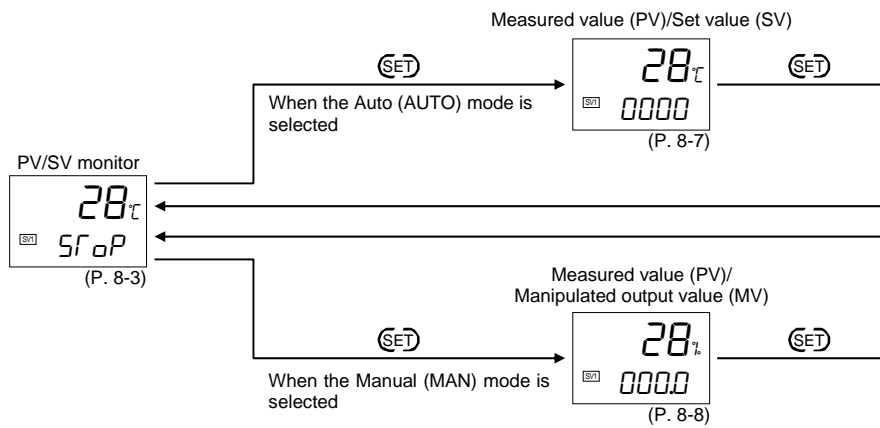

The Set value (SV) can also be set in Parameter setting mode (P. 8-13).

8.2.2 Setting item

Measured value (PV)/Set value (SV)

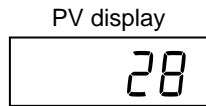

PV display:

The Measured value (PV) is displayed.

SV display:

The Set value (SV1 to SV4) for control can be set.

Only the Set value of the SV indicated in the STEP set value lamp can be set.

STEP set value lamp

Set value of SV1 can be set
as SV1 is indicated in the STEP
set value lamp.

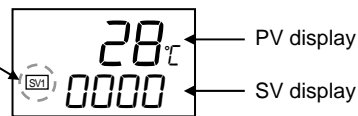

Display or data range	Factory set value
Setting limiter low to Setting limiter high	0 (0.0)



The Set values showed on the PV/SV display link to the Set values (SV1 to SV4) in the Parameter setting mode and Engineering mode.

Set values in the Parameter setting mode and the Engineering mode are automatically changed to the same values in accordance with the change of Set values set on the PV/SV display.



For details on changing the Set value (SV), refer to **5.2 Operation Setting (P. 5-6)**.

Related parameters

Parameter setting mode:

- Set value 1 (SV1) to Set value (SV4) (P. 8-13)

Engineering mode:

- Set value 1 (SV1) to Set value (SV4) (P. 8-60)

Measured value (PV)/Manipulated output value (MV)

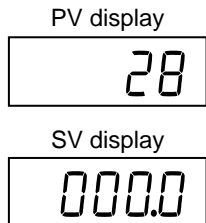

PV display:
The Measured value (PV) is displayed.

SV display:
When the operation mode is the Manual (MAN) mode, the Manipulated output value (MV) can be set.

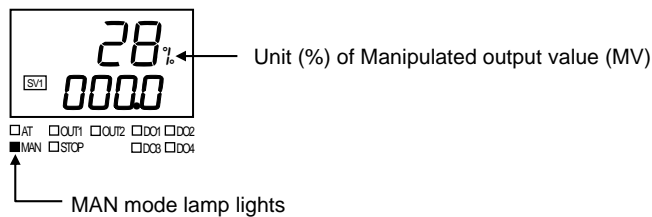

Display or Data range	Factory set value
PID control: Output limiter low to Output limiter high	0.0
Heat/Cool PID control: -Cool-side output limiter (high) to +Heat-side output limiter (high)	0.0

The Manipulated output value (MV) on the PV/SV display link to the Manipulated output values (MV) in the Parameter setting mode and Engineering mode. Manipulated output value (MV) in the Parameter setting mode and the Engineering mode are automatically changed to the same values in accordance with the change of Manipulated output value (MV) set on the PV/SV display. Manipulated output values (MV) is not displayed as the default value of the block selection at F10 (P. 8-87) when set to “1: No display” in the Engineering mode. To show the parameter, set the value to “0: Display.”

For details on changing the Manipulated output value (MV), refer to **6.5 Auto/Manual Transfer (P. 6-20)**.

Related parameters

Parameter setting mode:

- Manual manipulated output value (MV) (P. 8-42)

Engineering mode:

- Manual manipulated output value (MV) (P. 8-86)

8.3 Mode Switching

In Mode switching, the following operations are possible.

- Auto (AUTO)/Manual (MAN) transfer
- Set data unlock/lock transfer
- Interlock release

To hide the parameters, set “No display” to Mode selection (no display) (P.8-58) at the Function block F00 in the Engineering mode.

8.3.1 Display sequence

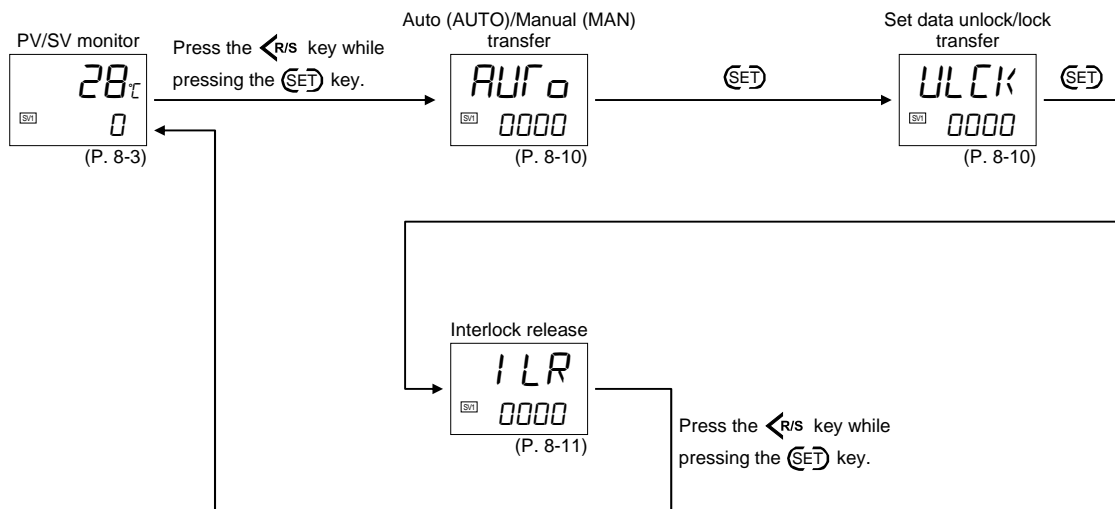

8.3.2 Setting item

Auto (AUTO)/Manual (MAN) transfer

〔Factory default setting:〕
The screen is displayed.

AUTO

Use to transfer the Auto (AUTO) mode or Manual (MAN) mode.

Auto (AUTO) mode: Automatic control is performed.

Manual (MAN) mode: The Manipulated output value (MV1 or MV2) can be manually changed.

MAN

Data range	Factory set value
0000: Auto (AUTO) mode	0000
0001: Manual (MAN) mode	

 To hide the Auto (AUTO)/Manual (MAN) transfer, set “No display” to Mode selection (no display) (P. 8-58) in the Engineering mode.

 For details of the Auto (AUTO)/Manual (MAN) transfer, refer to **6.5 Auto/Manual Transfer (P. 6-20)**.

Related parameters

Engineering mode:

- Mode selection (no display) (P. 8-58)

Set data unlock/lock transfer

〔Factory default setting:〕
The screen is displayed.

ULCK

Lock or unlock the setting data.

LCK

Data range	Factory set value
0000: Unlock	0000
0001: Lock	

 To lock parameters, select the parameters at Set lock level (P. 8-57) in the Engineering mode.

 To hide the parameter of Set data unlock/lock transfer, set “No display” to the Mode selection (no display) (P. 8-58) if the Engineering mode.

 For details of the Set data unlock/lock transfer, refer to **6.6 Protecting Setting Data (P. 6-24)**.

Related parameters

Engineering mode:

- Set lock level (P. 8-57)
- Mode selection (no display) (P. 8-58)





Interlock release

Factory default setting:
The screen is displayed.

ILR

Release the interlock state of event.

Data range	Factory set value
0000: Interlock release	0000
0001: Interlock state (only monitor)	

-  In order to validate the event interlock function, it is necessary to set to “1: Used” in item Event 1 to 4 interlock.
-  No event interlock can be released when in the alarm state. Release the Event interlock after the cause of the event is cleared up.
-  To hide Interlock release, set “No display” to the Mode selection (no display) (P. 8-58) in the Engineering mode.
-  For interlock release operation, refer to **6.8 Interlock Release (P. 6-39)**.

Related parameters

Engineering mode:

- Mode selection (no display) (P. 8-58)
- Event 1 interlock (P. 8-120)
- Event 2 interlock (P. 8-120)
- Event 3 interlock (P. 8-120)
- Event 4 interlock (P. 8-120)

8.4 Parameter Setting Mode

Set values (SV), Event set values, timer parameters and control parameters can be set in this mode.

8.4.1 Display sequence

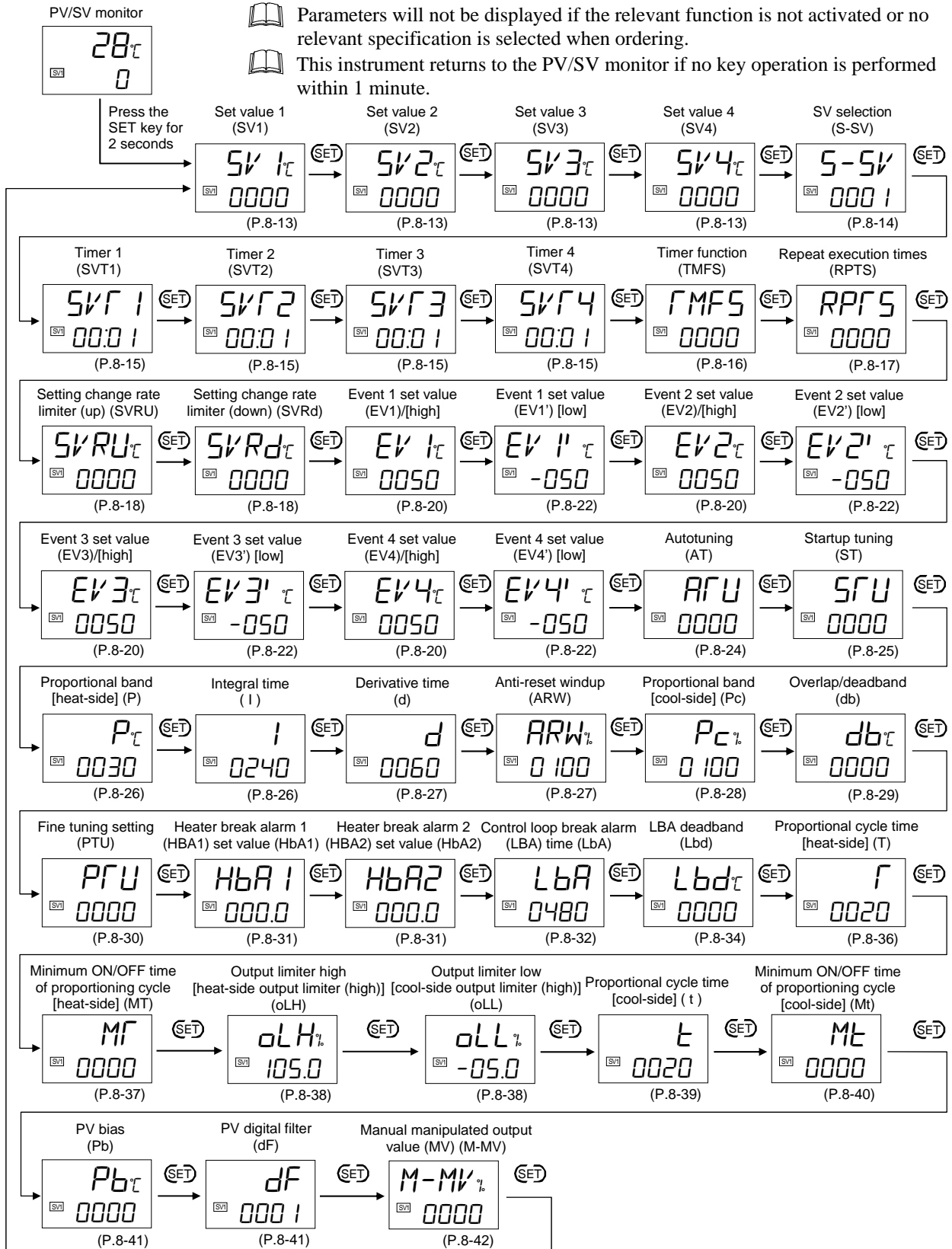

8.4.2 Parameter setting item

Set value 1 (SV1)

Set value 2 (SV2)

Set value 3 (SV3)

Set value 4 (SV4)

〔Factory default setting:
The screen is not displayed.〕

SV1

SV2

SV3

SV4

Set value (SV) for control can be set.

Up to four Set values (SV) can be stored. The (SV) selection function (SV step function) can be used to change individual values. The Timer function can also be used to make (SV) changes.

Data range	Factory set value
Setting limiter low to Setting limiter high	0 (0.0)



Set value (SV) is not displayed as the default when the block selection at F01 [5. F01] (P. 8-62) is set to “1: No display” in the Engineering mode.

To show the parameter, set the value to “0: Display.”

Set value (SV) set at SV selection shows up in the SV setting mode.



For the operating procedure of the SV selection function, refer to **7.1 SV Selection Function (SV Step Function) (P. 7-2)**.



For the operating procedure of the Timer function, refer to **7.2 Timer Function (P. 7-5)**.

Related parameters

Parameter setting mode:

- SV selection (P. 8-14)
- Timer 1, Timer 2, Timer 3, Timer 4 (P. 8-15)
- Timer function (P. 8-16)
- Repeat execution times (P. 8-17)
- Setting change rate limiter (up), Setting change rate limiter (down) (P. 8-18)

Engineering mode:

- Set value 1 (SV1), Set value 2 (SV2), Set value 3 (SV3), Set value 4 (SV4) (P. 8-60)
- Setting limiter high, Setting limiter low (P. 8-93)

SV selection

(Factory default setting:
The screen is not displayed.)

5-SV

Select Set value (SV) for control from SV 1 to SV 4.

Data range	Factory set value
1 to 4	1



This function is not available when SV selection is operated by Timer function 3, Timer function 4 or digital input (DI).



SV selection is not displayed as the default when the block selection at F01 [5. F0 1] (P. 8-62) is set to “1: No display” in the Engineering mode. To show the parameter (SV), set the value to “0: Display.”

Related parameters

Parameter setting mode:

- Set value 1 (SV1), Set value 2 (SV2), Set value 3 (SV3), Set value 4 (SV4) (P. 8-13)

Engineering mode:

- SV selection (P. 8-61)

Timer 1
 Timer 2
 Timer 3
 Timer 4

(Factory default setting:
 The screen is not displayed.)

SVF1



SVF2

SVF3

SVF4

Set Timer time in the Timer function to change Set value (SV).

Data range	Factory set value
00 minute 01 seconds to 99 minutes 59 seconds or 00 hour 01 minutes to 99 hours 59 minutes [Factory set value of time unit of timer: 0 (min.: sec.)]	00:01

-  Timer time is not displayed as the default when the block selection at F02 [5. F02] (P. 8-65) is set to “1: No display” in the Engineering mode.
 To show the parameter, set the value to “0: Display.”
-  Set Timer time unit (FMU) at Function block 70 [F70] (P. 8-136) in the Engineering mode.
-  For the operating procedure of the Timer function, refer to **7.2 Timer Function (P. 7-5)**.

Related parameters

Parameter setting mode:

- Timer function (P. 8-16)
- Repeat execution times (P. 8-17)

Engineering mode:

- Timer 1, Timer 2, Timer 3, Timer 4 (P. 8-63)
- Timer time unit (P. 8-136)

Timer function

(Factory default setting:
The screen is not displayed.)

FMFS

Up to four types of Timer functions are available.

Data range	Factory set value
0 (Unused), 1 (Timer function 1) to 4 (Timer function 4)	0



- Timer function 1: Use the Set value (SV) set at SV selection to start control when time has expired.
- Timer function 2: Use the Set value (SV) set at SV selection to stop control when time has expired.
- Timer function 3: Link Set values from SV1 to SV4 to operate ramp/soak control and continue to control the SV4 after the timer time has expired.
- Timer function 4: Link Set values from SV1 to SV4 to operate ramp/soak control and stop controlling the SV4 after the timer time.



Timer function is not displayed as the default when the block selection at F02 [5. F02] (P. 8-65) is set to “1: No display” in the Engineering mode. To show the parameter, set the value to “0: Display.”



For the operating procedure of the Timer function, refer to **7.2 Timer Function (P. 7-5)**.

Related parameters

Parameter setting mode:

- Timer 1, Timer 2, Timer 3, Timer 4 (P. 8-15)
- Repeat execution times (P. 8-17)

Engineering mode:

- Timer function (P. 8-64)



Repeat execution times

〔Factory default setting:
The screen is not displayed.〕

RPTS

Set Repeat execution times to repeat the ramp/soak control using Timer function 3 or 4.

Data range	Factory set value
0 to 9999 (9999: Infinite times)	0

-  Timer function 3 or 4 should be selected to ramp/soak control.
-  Repeat execution times is not displayed as the default in the block selection at F02 [5. F02] (P. 8-65) is set to “1: No display” in the Engineering mode. To show the parameter, set the value to “0: Display.”
-  For the process of ramp/soak control with Repeat execution times, refer to **■ Ramp/Soak control (Timer function 3, Timer function 4) (P. 7-9).**

Related parameters

Parameter setting mode:

- Timer 1, Timer 2, Timer 3, Timer 4 (P. 8-15)
- Timer function (P. 8-16)

Engineering mode:

- Repeat execution times (P. 8-64)

Setting change rate limiter (up) Setting change rate limiter (down)

〔Factory default setting:
The screen is not displayed.〕

SVRU

SVRd

Set the values for Setting change rate limiter up and down.

Data range	Factory set value
1 (0.1) to Input span (Unit °C [°F])/unit time 0: Unused [Factory set value of unit time: 0 (minute)]	0 (0.0)

 Setting change rate limiter is not displayed as the default when the block selection at F03 [5.F03] (P. 8-67) is set to “1: No display” in the Engineering mode. To show the parameter, set the value to “0: Display.”

 Set the unit time at Setting change rate limiter unit time (SVRF) at F70 (P. 8-136) in the Engineering mode.

Related parameters

Engineering mode:

- Setting change rate limiter (up), Setting change rate limiter (down) (P. 8-66)
- Setting change rate limiter unit time (P. 8-136)

Continued on the next page.

Continued from the previous page.

■ Description of function

This function is to allow the Set value (SV) to be automatically changed at specific rates when a new Set value (SV). $SVRU$ is used when the SV is changed to a higher SV. $SVRD$ is used when the SV is changed to a lower SV.

[Application examples of Setting change rate limiter]

• Increasing the SV to a higher value

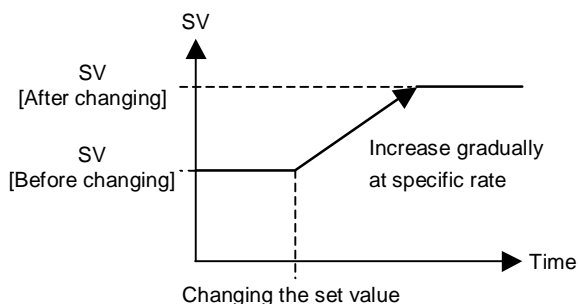

• Decreasing the SV to a lower value

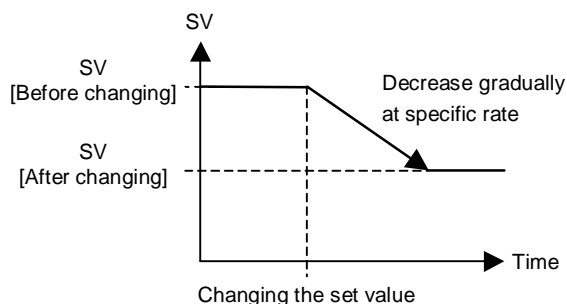

When the Setting change rate limiter is used, the SV will also ramp up or ramp down by the function at power-on and operation mode change from STOP to RUN.



If the Autotuning (AT) function is activated while the SV is ramping up or ramping down by the Setting change rate limiter, AT will start after the SV finishes ramp-up or ramp-down by the limiter, and the controller is in PID control mode until AT starts.



When the value of Setting change rate limiter is changed during normal operation, the ramp-up or ramp-down rate will be changed unless the SV already has finished ramp-up or ramp-down by the function.



If control is stopped during the Setting change rate limiter, the value at that point is considered the Set value (SV). Setting change rate limiter is canceled.



If the Setting change rate limiter is set to any value other than "0 (Unused)," the event re-hold action to be taken by a Set value (SV) change becomes invalid.



Setting change rate limiter is available during the Manual mode (MAN).

**Event 1 set value (EV1), Event 1 set value (EV1) [high]
 Event 2 set value (EV2), Event 2 set value (EV2) [high]
 Event 3 set value (EV3), Event 3 set value (EV3) [high]
 Event 4 set value (EV4), Event 4 set value (EV4) [high]**

Factory default setting:
 The screen is displayed.

EV1





Set Event set value. When high/low individual setting is selected for the event type, the value is the Event set value [high].

EV2

EV3

EV4

Data range	Factory set value
Event 1 set value (EV1) to Event 4 set value (EV4): Deviation action: -Input span to +Input span Input value or set value action: Same as input range	TC/RTD inputs: 50 (50.0) Voltage (V)/Current (I) inputs: 5.0
Event 1 set value (EV1) [high] to Event 4 set value (EV4) [high]: -Input span to +Input span	

-  Event set value or Event set value [high] is not displayed when the block selection at F04 [5.F04] (P. 8-70) is set to “1: No display” in the Engineering mode.
-  Event set value or Event set value [high] is not displayed when the Event 1 type (E51) to Event 4 type (E54) at the Function blocks from F41 to F44 (P. 8-101) are set to “0: No event” in the Engineering mode.
-  This parameter will not be displayed if Event 1 type (E51) to Event 4 type (E54) (P. 8-101) has been set to “11: Control loop break alarm (LBA), 13: FAIL, 12: Monitor during RUN, 22: Heater break alarm (HBA) or 23: Output of the communication monitoring result” in Function block 41 (F41) to 44 (F44) of Engineering mode.
-  Event 3 and 4 are displayed when 4 points of digital outputs (DO) are specified. When relay contact output is specified to OUT2 on RB100 PID control, parameter of Event 3 will display.
-  For the setting of the Event set value, refer to ■ **Set the Event set value (EV) (P. 5-7).**

Continued on the next page.

Continued from the previous page.

Related parameters

Parameter setting mode:

- Event 1 set value (EV1') [low] to Event 4 set value (EV4') [low] (P. 8-22)

Engineering mode:

- Event 1 set value (EV1) to Event 4 set value (EV4) (P. 8-68)
- Event 1 set value (EV1) [high] to Event 4 set value (EV4) [high] (P. 8-68)
- Event 1 type to Event 4 type (P. 8-101)
- Event 1 hold action to Event 4 hold action (P. 8-110)
- Event 1 differential gap to Event 1 differential gap (P. 8-113)
- Event 1 output action at input burnout to Event 4 output action at input burnout (P. 8-115)
- Energized/De-energized of Event 1 output to Energized/De-energized of Event 4 output (P. 8-116)
- Event 1 timer to Event 4 timer (P. 8-118)
- Event 1 interlock to Event 4 interlock (P. 8-120)

Event 1 set value (EV1') [low]

Event 2 set value (EV2') [low]

Event 3 set value (EV3') [low]

Event 4 set value (EV4') [low]

Factory default setting:
The screen is displayed.

EV 1'

EV 2'

EV 3'

EV 4'

When high/low individual setting is selected for the Event type, the value is the Event set value [low]. Use with Event set value [high].

Data range	Factory set value
-Input span to +Input span	TC/RTD inputs: -50 (-50.0) Voltage (V)/Current (I) inputs: -5.0

 Event set value or Event set value [high] are not displayed when the block selection at F04 [5.F04] (P. 8-70) is set to "1: No display" in the Engineering mode.

 Event set value or Event set value [high] are not displayed when the Event 1 type (E5 1) to Event 4 type (E5 4) at the Function blocks from F41 to F44 (P. 8-101) are set to "0: No event" in the Engineering mode.

 This parameter will not be displayed if Event 1 type (E5 1) to Event 4 type (E5 4) (P. 8-101) has been set to "11: Control loop break alarm (LBA), 13: FAIL, 12: Monitor during RUN, 22: Heater break alarm (HBA) or 23: Output of the communication monitoring result" in Function block 41 (F41) to 44 (F44) of Engineering mode.

 Event 3 and 4 display when 4 points of digital outputs (DO) are specified. When relay output is specified to OUT2 on RB100 PID control, parameter of Event 3 displays.

 For the setting of the Event set value, refer to **Set the Event set value (EV) (P. 5-7)**.

Continued on the next page.

Continued from the previous page.

Related parameters

Parameter setting mode:

- Event 1 set value (EV1) [high] to Event 4 set value (EV4) [high] (P. 8-20)

Engineering mode:

- Event 1 set value (EV1') [low] to Event 4 set value (EV4') [low] (P. 8-69)
- Event 1 type to Event 4 type (P. 8-101)
- Event 1 hold action to Event 4 hold action (P. 8-110)
- Event 1 differential gap to Event 4 differential gap (P. 8-113)
- Event 1 output action at input burnout to Event 4 output action at input burnout (P. 8-115)
- Energized/De-energized of Event 1 output to Energized/De-energized of Event 4 output (P. 8-116)
- Event 1 timer to Event 4 timer (P. 8-118)
- Event 1 interlock to Event 4 interlock (P. 8-120)

Autotuning (AT)

Factory default setting:
The screen is displayed.

ATU

To set Autotuning (AT), set the value to “1.” This allows automated calculating of proportional, integral and derivation.

Data range	Factory set value
0: PID control	0
1: Autotuning (AT)	

 Autotuning (AT) is not displayed when the block selection at F05 [5.F05] (P. 8-72) is set to “1: No display” in the Engineering mode.

 For starting method and conditions for Autotuning (AT), refer to **6.2 Autotuning (AT) (P. 6-8)**.

Related parameters

Engineering mode:

- Autotuning (AT) (P. 8-71)
- AT cycles (P. 8-130)
- AT differential gap time (P. 8-131)

Startup tuning (ST)

〔Factory default setting: The screen is displayed.〕

STU

Use to set the number of execution times of Startup tuning (ST).

Data range	Factory set value
0: ST unused 1: Execute once 2: Execute always	0

📖 Startup tuning (ST) is not displayed when the block selection at F05 [5.F05] (P. 8-72) is set to “1: No display” in the Engineering mode.

📖 When in Heat/Cool PID control, it is possible to execute the Startup tuning (ST) function only in the temperature rise direction. The PID values on the heat side are automatically calculated.

📖 If the optimum PID constants cannot be obtained by the Startup tuning (ST), please execute the Autotuning (AT).

👉 For details of the Startup tuning (ST), refer to **6.3 Startup Tuning (ST) (P. 6-11)**.

Related parameters

Engineering mode:

- Startup tuning (ST) (P. 8-71)
- ST start condition (P. 8-132)

■ Description of function

The Startup tuning (ST) function is used to automatically calculate PID constants from the temperature rise characteristic (gradient: arrival time to SV) when power is turned on or the Set value (SV) is changed. Startup tuning (ST) eliminates the lag time in applications when conventional autotuning requires a long time.

Timing of activating the Startup tuning (ST) can be selected from among the following three types.

- Activate the Startup tuning (ST) function when the power is turned on; when transferred from STOP to RUN; or when the Set value (SV) is changed.
- Activate the Startup tuning (ST) function when the power is turned on; or when transferred from STOP to RUN.
- Activate the Startup tuning (ST) function when the Set value (SV) is changed.

Activate the Startup tuning (ST) function when the power is turned on; or when transferred from STOP to RUN.

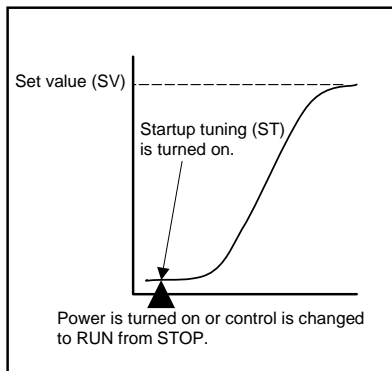

Activate the Startup tuning (ST) function when the Set value (SV) is changed.

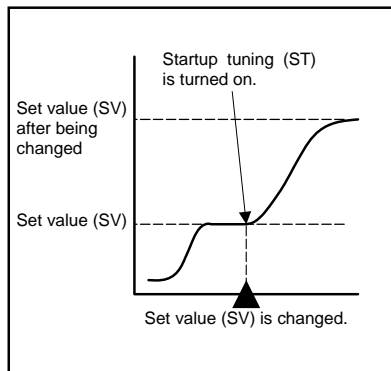

Activate the Startup tuning (ST) function when the power is turned on; when transferred from STOP to RUN; or when the Set value (SV) is changed.

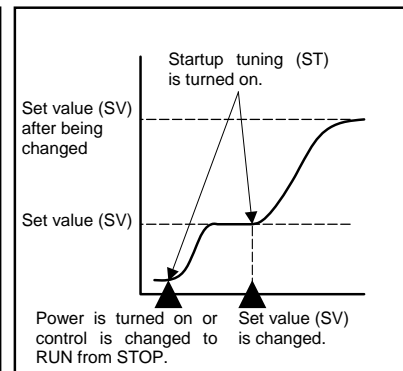

Proportional band [heat-side]

〔Factory default setting:
The screen is displayed.〕



This is a Proportional band in P, PI, PD or PID control. When in Heat/Cool PID control, it becomes the Proportional band on the heat side.

Data range	Factory set value
TC/RTD inputs: 1 (0.1) to Input span (Unit: °C [°F]) [Resolution of 0.1 °C (°F): Within 999.9 °C (°F)] 0 (0.0): ON/OFF action (Heat/Cool PID control: Heat-side and cool-side are both ON/OFF action)	30 (30.0)
Voltage (V)/Current (I) inputs: 0.1 to 100.0 % of Input span 0.0: ON/OFF action	3.0

Proportional band [heat-side] is not displayed when the block selection at F06 [5.F06] (P. 8-76) is set to “1: No display” in the Engineering mode.

Related parameters

Parameter setting mode:

- Anti-reset windup (ARW) (P. 8-27)

Engineering mode:

- Proportional band [heat-side] (P. 8-73)
- Direct/Reverse action (P. 8-124)
- ON/OFF action differential gap (upper),
ON/OFF action differential gap (lower) (P. 8-126)
- Control output at burnout (P. 8-127)

Integral time

〔Factory default setting:
The screen is displayed.〕

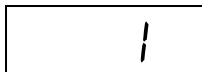

Integral action is to eliminate offset between SV and PV by proportional action. For Heat/Cool PID control, the integral time is same on both heat-side and cool-side.

Data range	Factory set value
PID control or Heat/Cool PID control: 1 to 3600 seconds (0: PD action)	240

Integral time is not displayed when the block selection at F06 [5.F06] (P. 8-76) is set to “1: No display” in the Engineering mode.

Related parameter

Engineering mode:

- Integral time (P. 8-73)

Derivative time

〔Factory default setting:
The screen is displayed.〕

d

Derivative action is to prevent rippling and make control stable by monitoring output change. For Heat/Cool PID control, the Derivative time is same on both heat-side and cool-side.

Data range	Factory set value
1 to 3600 seconds (0: PI action)	60

 Derivative time is not displayed when the block selection at F06 [5.F06] (P. 8-76) is set to “1: No display” in the Engineering mode.

Related parameters

Engineering mode:

- Derivative time (P. 8-74)
- Derivative action (P. 8-128)

Anti-reset windup (ARW)

〔Factory default setting:
The screen is displayed.〕

ARW

In order to prevent an overshoot caused by the integral effect, sets the value to restrict the effective range of integral action.

Data range	Factory set value
1 to 100 % of Proportional band [heat-side] (0: Integral action is always OFF)	100

 Anti-reset windup (ARW) is not displayed when the block selection at F06 [5.F06] (P. 8-76) is set to “1: No display” in the Engineering mode.

Related parameters

Parameter setting mode:

- Proportional band [heat-side] (P. 8-26)

Engineering mode:

- Anti-reset windup (P. 8-74)



Proportional band [cool-side]

〔Factory default setting:
The screen is displayed.〕

P_c

This is a Proportional band for the cool side in Heat/Cool PID control.

Data range	Factory set value
1 to 1000 % of Proportional band [heat-side]	100

-  Proportional band [cool-side] is not displayed when the block selection at F06 [S.F06] (P. 8-76) is set to “1: No display” in the Engineering mode.
-  This parameter is displayed when in Heat/Cool PID control.
-  ON/OFF action of cool-side only is not possible.

Related parameters

Parameter setting mode:

- Proportional band [heat-side] (P. 8-26)
- Overlap/Deadband (P. 8-29)

Engineering mode:

- Proportional band [cool-side] (P. 8-74)
- Cool action (P. 8-125)



Overlap/Deadband

Factory default setting:
The screen is displayed.

db

This is the overlapped range of proportional bands (on the heat and cool sides) or the deadband range when Heat/Cool PID control is performed.

Data range	Factory set value
TC/RTD inputs: -10 (-10.0) to +10 (+10.0) °C [°F]	0 (0.0)
Voltage (V)/Current (I) inputs: -10.0 to +10.0 % of Input span	0.0

-  Minus (-) setting results is overlap.
-  This parameter is displayed when in Heat/Cool PID control.
-  Overlap/Deadband is not displayed when the block selection at F06 [5.F06] (P. 8-76) is set to “1: No display” in the Engineering mode.

Related parameters

Parameter setting mode:

- Proportional band [heat-side] (P. 8-26)
- Proportional band [cool-side] (P. 8-28)

Engineering mode:

- Overlap/Deadband (P. 8-75)
- Cool action (P. 8-125)

■ Description of function

Overlap (OL): Range in which the Proportional band [heat-side] and the Proportional band [cool-side] are overlapped. If a Measured value (PV) is within the overlapped range, Manipulated output values (MV1 and MV2) may be simultaneously output.

Deadband (DB): This is a control dead zone existing between the Proportional band [heat-side] and the Proportional band [cool-side]. If a Measured value (PV) is within the deadband range, neither the Manipulated output value (MV1) nor the Manipulated output value (MV2) is output.

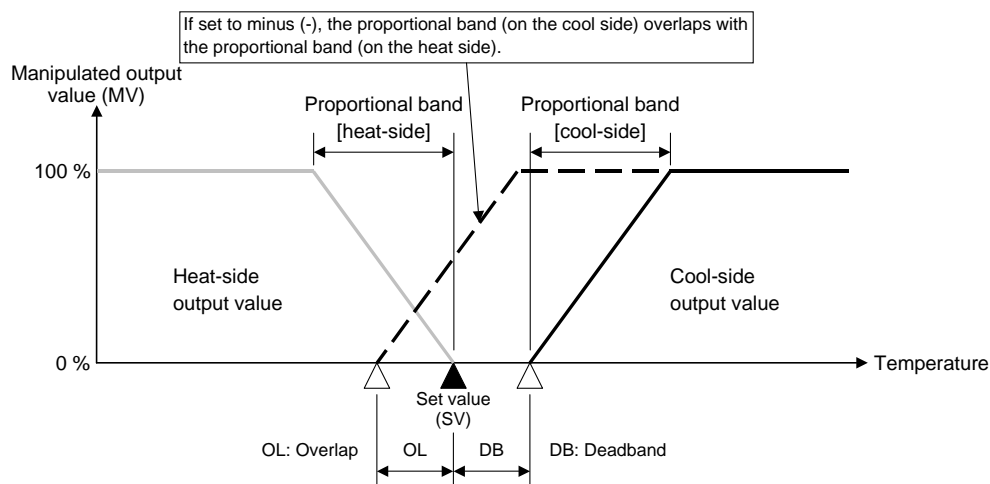

Fine tuning setting

〔Factory default setting:
The screen is displayed.〕

PTU

Fine tuning function allows the operator to adjust the control response speed without changing PID values.

Data range	Factory set value
-3 to +3 (0: Unused)	0

 Positive values quicken the control response while negative values slow the control response.

 Fine tuning setting is not displayed when the block selection at F06 [5.F06] (P. 8-76) is set to “1: No display” in the Engineering mode.

 For the Fine tuning function, refer to **6.4 Fine Tuning (P. 6-17)**.

Related parameters

Engineering mode:

- Fine tuning setting (P. 8-75)

Heater break alarm 1 (HBA1) set value

Heater break alarm 2 (HBA2) set value

〔Factory default setting:
The screen is displayed.〕

HBA1

HBA1 and HBA2 are to set the set values for the Heater break alarm (HBA) function.

HBA2

Data range	Factory set value
0.0 to 30.0 A (CTL-6-P-N)	0.0
0.0 to 100.0 A (CTL-12-S56-10L-N)	
(0.0: Unused [Current value can be monitored])	

 HBA1 and HBA2 display when CT input (optional) is specified and the value “22: Heater break alarm (HBA)” is set to Event 1 type (E51) through Event 4 type (E54) (P. 8-101) at Function blocks from F41 to F44 in the Engineering mode.

 HBA1 and HBA2 are not displayed when the block selection at F07 [5.F07] (P. 8-79) is set to “1: No display” in the Engineering mode.

Related parameters

Engineering mode:

- Heater break alarm 1 (HBA1) set value, Heater break alarm 2 (HBA2) set value (P. 8-77)
- CT ratio (Number of turns) (P. 8-122)
- Number of HBA delay times (P. 8-123)

■ For the setting of the Heater break alarm

- Set the set value to approximately 85 % of the maximum reading of the CT input.
- Set the set value to a slightly smaller value to prevent a false alarm if the power supply becomes unstable.
- When more than one heater is connected in parallel, the HBA set value may need to be increased to detect a single heater failure.

■ Description of function

Heater break alarm (HBA) can only be used with time-proportional control output (relay, voltage pulse, or triac output).

The HBA function monitors the current flowing through the load by a dedicated current transformer (CT), then compares the measured value with the HBA set values, and detects a fault in the heating circuit.

Low or No current flow (Heater break, malfunction of the control device, etc.):

When the control output is ON and the CT input value is equal to or less than the heater break determination point for the preset number of consecutive sampling cycles, an alarm is activated.

Over current or short-circuit:

When the control output is OFF and the CT input value is equal to or greater than the heater break determination point for the preset number of consecutive sampling cycles, an alarm is activated.

Control loop break alarm (LBA) time

Factory default setting:
The screen is displayed.

LBA

The LBA time sets the time required for the LBA function to determine there is a loop failure. When the LBA is output (under alarm status), the LBA function still monitors the Measured value (PV) variation at an interval of the LBA time.

Data range	Factory set value
0 to 7200 seconds (0: Unused)	480

 LBA displays when PID control is specified and the value “11: Control loop break alarm (LBA)” is set to Event 1 type (E5 l) through Event 4 type (E54) (P. 8-101) at Function blocks from F41 to F44 in the Engineering mode.

 LBA is not displayed when Heat/Cool PID control is specified.

 LBA is not displayed when the block selection at F07 [5.F07] (P. 8-79) is set to “1: No display” in the Engineering mode.

Related parameters

Parameter setting mode:

- LBA deadband (LBD) (P. 8-34)

Engineering mode:

- Control loop break alarm (LBA) time (P. 8-78)

■ Description of function

The Control loop break alarm (LBA) function is used to detect a load (heater) break or a failure in the external actuator (power controller, magnet relay, etc.), or a failure in the control loop caused by an input (sensor) break. The LBA function is activated when control output reaches 0 % (low limit with output limit function) or 100 % (high limit with output limit function). LBA monitors variation of the Measured value (PV) for the length of LBA time. When the LBA time has elapsed and the PV is still within the alarm determination range, the LBA will be ON.

Continued on the next page.

Continued from the previous page.

[Alarm action]

LBA determination range: Thermocouple/RTD input: 2 °C [°F] fixed

Voltage/Current input: 0.2 % of span fixed

• **When the output reaches 0 % (low limit with output limit function)**

For direct action: When the LBA time has passed and the PV has not risen beyond the alarm determination range, the alarm will be turned on.

For reverse action: When the LBA time has passed and the PV has not fallen below the alarm determination range, the alarm will be turned on.

• **When the output exceeds 100 % (high limit with output limit function)**

For direct action: When the LBA time has passed and the PV has not fallen below the alarm determination range, the alarm will be turned on.

For reverse action: When the LBA time has passed and the PV has not risen beyond the alarm determination range, the alarm will be turned on.



If the Autotuning function is used, the LBA time is automatically set twice as large as the integral time. The LBA setting time will not change even if the integral time is changed.



If the LBA function detects an error occurring in the control loop, but cannot specify the location, the control loop should be checked. The LBA function does not detect the location which causes alarm status. If LBA alarm is ON, check each device or wiring in the control loop.

LBA deadband (LBD)

Factory default setting:
The screen is displayed.

Lbd

The LBA deadband gives a neutral zone to prevent the control loop break alarm (LBA) from malfunction caused by disturbance.

Data range	Factory set value
0 to Input span	0

 LBD displays when PID control is specified and the value “11: Control loop break alarm (LBA)” is set to Event 1 type (E5 l) through Event 4 type (E54) (P. 8-101) at Function blocks from F41 to F44 in the Engineering mode.

 LBD is not displayed when Heat/Cool PID control is specified.

 LBD is not displayed when the block selection at F07 [5.F07] (P. 8-79) is set to “1: No display” in the Engineering mode.

Related parameters

Parameter setting mode:

- Control loop break alarm (LBA) time (P. 8-32)

Engineering mode:

- LBA deadband (LBD) (P. 8-78)

■ Description of function

The LBA may malfunction due to external disturbances. To prevent malfunction due to external disturbance, LBA deadband (LBD) sets a neutral zone in which LBA is not activated. When the Measured value (PV) is within the LBD area, LBA will not be activated. If the LBD setting is not correct, the LBA will not work correctly.

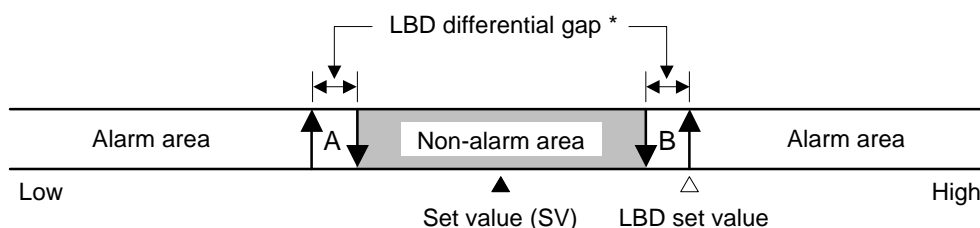

* TC/RTD input: 0.8 °C [°F] (fixed) Voltage/Current input: 0.8 % of span (fixed)

A: During temperature rise: Alarm area During temperature fall: Non-alarm area
 B: During temperature rise: Non-alarm area During temperature fall: Alarm area

Continued on the next page.

Continued from the previous page.



LBA function is not operative when:

- When AT function is activated.
- When the controller is in STOP mode.
- LBA time is set to “0.”
- LBA function is not assigned to Event 1 (ES1) to Event 4 (ES4).



If the LBA time is too short or does not match the controlled object requirements, LBA may turn ON or OFF at inappropriate time or remain OFF. Change the LBA time based on the malfunction.



While the LBA is ON (under alarm status), the following conditions will cancel the alarm status and LBA will be OFF:

- The Measured value (PV) rises beyond (or falls below) the LBA determination range within the LBA time.
- The Measured value (PV) enter within the LBA deadband.

Proportional cycle time [heat-side]

〔Factory default setting:
The screen is displayed.〕



Proportional cycle time is to set control cycle time for time based control output such as voltage pulse for SSR, triac, relay and open-collector output. When in Heat/Cool PID control, it becomes the proportional cycle time on the heat-side.

Data range	Factory set value
0 to 100 seconds When 0 seconds is set to the Proportional cycle time [heat-side] in the Parameter setting mode, the control cycle time for outputs is the value set at the Time setting of proportional cycle time [heat-side] (<i>FL</i>) at F51 (P. 8-129) in the Engineering mode.	Relay contact output (M): 20 ----- Voltage pulse output (V), Triac output (T), Open collector output: 2

Proportional cycle time [heat-side] displays when relay contact output, voltage pulse output, triac output or open collector output is specified to control output 1 (OUT1).

Proportional cycle time [heat-side] is not displayed when the block selection at F08 [*5.F08*] (P. 8-83) is set to “1: No display” in the Engineering mode.

Related parameters

Parameter setting mode:

- Minimum ON/OFF time of proportioning cycle [heat-side] (P. 8-37)

Engineering mode:

- Proportional cycle time [heat-side] (P. 8-80)
- Time setting of proportional cycle time [heat-side] (P. 8-129)

Minimum ON/OFF time of proportioning cycle [heat-side]

〔Factory default setting:〕
The screen is displayed.

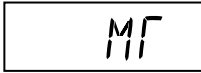

This is the Minimum ON/OFF time of the time proportioning cycle [heat-side].

Data range	Factory set value
0 to 1000 ms	0

Minimum ON/OFF time of proportioning cycle [heat-side] displays when relay contact output, voltage pulse output, triac output or open collector output is specified to control output 1 (OUT1).

Minimum ON/OFF time of proportioning cycle [heat-side] is not displayed when the block selection at F08 [5.F08] (P. 8-83) is set to “1: No display” in the Engineering mode.

Related parameters

Parameter setting mode:

- Proportional cycle time [heat-side] (P. 8-36)

Engineering mode:

- Minimum ON/OFF time of proportioning cycle [heat-side] (P. 8-80)

■ Description of function

The Minimum ON/OFF time of the proportioning cycle is used to prevent output ON or OFF when the output is greater than 0 % or less than 100 %. This is useful when you need to establish a minimum ON/OFF time to prolong the life of the relay.

Example 1: Setting of Minimum ON/OFF time of proportioning cycle > Computed output

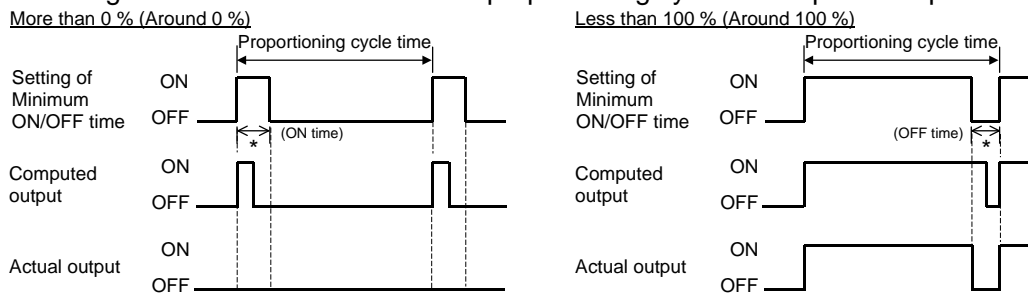

* When a long minimum ON/OFF time is required for the relay, set a time longer than that time.

Example 2: Setting of Minimum ON/OFF time of proportioning cycle ≤ Computed output

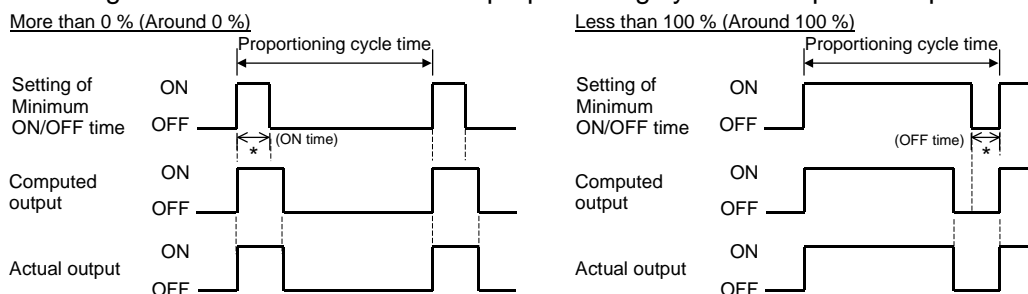

* When a long minimum ON/OFF time is required for the relay, set a time longer than that time.



The minimum ON/OFF time of the proportioning cycle becomes invalid when the Voltage/Current output is selected.



Operation will not take place if “Proportional cycle time < Minimum ON/OFF time of proportioning cycle.”

Output limiter high
[Heat-side output limiter (high)]
Output limiter low
[Cool-side output limiter (high)]

(Factory default setting:
The screen is displayed.)

oLH

Output limiter high [Heat-side output limiter (high)]:

Use to set the high limit value of Manipulated output (MV1) [heat-side].

oLL

Output limiter low [Cool-side output limiter (high)]:

Use to set the low limit value of Manipulated output (MV1) [heat-side] or the high limit value of Manipulated output (MV2) [cool-side].

Data range	Factory set value
Output limiter high [Heat-side output limiter (high)]: PID control: Output limiter low to 105.0 % Heat/Cool PID control: 0.0 to 105.0 %	105.0
Output limiter low [Cool-side output limiter (high)]: PID control: -5.0 % to Output limiter high (Output limiter high > Output limiter low) Heat/Cool PID control: 0.0 to 105.0 %	PID control: -5.0 Heat/Cool PID control: 105.0

 Output limiter high/low is not displayed when the block selection at F08 [5.F08] (P. 8-83) is set to "1: No display" in the Engineering mode.

Related parameters

Engineering mode:

- Output limiter high [Heat-side output limiter (high)] (P. 8-81)
- Output limiter low [Cool-side output limiter (high)] (P. 8-81)

■ Description of function

This function restricts the high and low limits of Manipulated output values (MV).

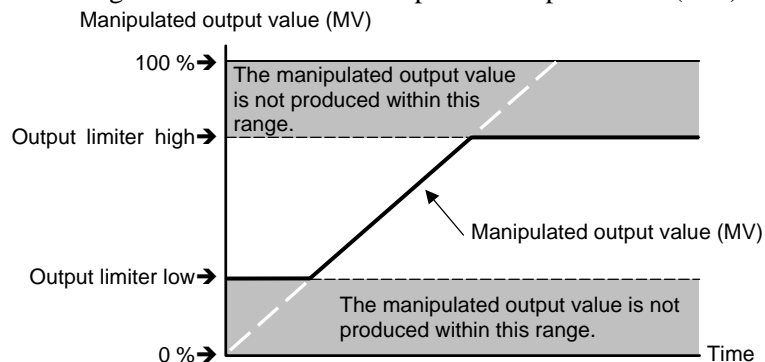

 Output limiter is available for ON/OFF action.



Proportional cycle time [cool-side]

〔Factory default setting:
The screen is displayed.〕



This is a Proportional cycle time of cool-side in the Heat/Cool PID control. Proportional cycle time [cool-side] is to set control cycle time for time based control output such as voltage pulse for SSR, triac, relay and open-collector output.

Data range	Factory set value
0 to 100 seconds When 0 seconds is set to the Proportional cycle time [cool-side] in the Parameter setting mode, the control cycle time for outputs is the value set at the Time setting of proportional cycle time [cool-side] (t _L) at F51 (P.8-129) in the Engineering mode.	Relay contact output (M): 20 ----- Voltage pulse output (V), Triac output (T), Open collector output: 2

-  This parameter is displayed when in Heat/Cool PID control.
-  Proportional cycle time [cool-side] displays when relay contact output, voltage pulse output, triac output or open collector output is specified to control output 2 (OUT2).
-  Proportional cycle time [cool-side] is not displayed when the block selection at F08 [5.F08] (P. 8-83) is set to “1: No display” in the Engineering mode.

Related parameters

Parameter setting mode:

- Minimum ON/OFF time of proportioning cycle [cool-side] (P. 8-40)

Engineering mode:

- Proportional cycle time [cool-side] (P. 8-81)
- Time setting of proportional cycle time [cool-side] (P. 8-129)



Minimum ON/OFF time of proportioning cycle [cool-side]

Factory default setting:
The screen is displayed.

ME

This is the Minimum ON/OFF time of the time proportioning cycle [cool-side].

Data range	Factory set value
0 to 1000 ms	0

-  This parameter is displayed when in Heat/Cool PID control.
-  Minimum ON/OFF time of proportioning cycle [cool-side] displays when relay contact output, voltage pulse output, triac output or open collector output is specified to control output 2 (OUT2).
-  Minimum ON/OFF time of proportioning cycle [cool-side] is not displayed when the block selection at F08 [5.F08] (P. 8-83) is set to “1: No display” in the Engineering mode.

Related parameters

Parameter setting mode:

- Proportional cycle time [cool-side] (P. 8-39)

Engineering mode:

- Minimum ON/OFF time of proportioning cycle [cool-side] (P. 8-82)

PV bias

〔Factory default setting:
The screen is displayed.〕

Pb

PV bias adds bias to the Measured value (PV). The PV bias is used to compensate the individual variations of the sensors or correct the difference between the Measured value (PV) of other instruments.

Data range	Factory set value
TC/RTD input: -1999 (-199.9) to +9999 (+999.9) °C [°F] Voltage (V)/Current (I) input: -Input span to +Input span	0 (0.0)

 PV bias is not displayed when the block selection at F09 [5.F09] (P. 8-85) is set to “1: No display” in the Engineering mode.

Related parameters

Engineering mode:

- PV bias (P. 8-84)

PV digital filter

〔Factory default setting:
The screen is displayed.〕

df

The PV filter is used to eliminate noise against the measured input.

Data range	Factory set value
0 to 100 seconds (0: Unused)	1

 PV digital filter is not displayed when the block selection at F09 [5.F09] (P. 8-85) is set to “1: No display” in the Engineering mode.

Related parameters

Engineering mode:

- PV digital filter (P. 8-84)



Manual manipulated output value (MV)

〔Factory default setting:
The screen is not displayed.〕

M - MV

Setting Manipulated output value (MV) in Manual (MAN) mode.

Data range	Factory set value
PID control: Output limiter low to Output limiter high Heat/Cool PID control: -Cool-side output limiter (high) to +Heat-side output limiter (high)	0.0

-  Manual manipulated output value (MV) is not displayed as the default value of the block selection at F10 [5.F 10] (P. 8-62) is set to “1: No display” in the Engineering mode. To show the parameter, set the value to “0: Display.”
-  When the instrument is in the Manual (MAN) mode, manual setting of the Manipulated output value is available at SV setting mode (P. 8-8).

Related parameters

Engineering mode:

- Manual manipulated output value (MV) (P. 8-86)

8.5 Engineering Mode

The Engineering mode allows the control to be set according to application requirements. For parameter details, refer to the **8.5.3 Engineering item list (P. 8-57)**.

⚠ WARNING

Parameters in the Engineering mode (F21 to F70) should be set according to the application before setting any parameter related to operation. Once the parameters in the Engineering mode are set correctly, no further changes need to be made to parameters for the same application under normal conditions. If they are changed unnecessarily, it may result in malfunction or failure of the instrument. RKC will not bear any responsibility for malfunction or failure as a result of improper changes in the Engineering mode.

 **To configure settings in Engineering mode (F21 to F70), the following steps must be performed:**

- Preset “0000” to the Set data unlock/lock transfer setting.
- Set STOP mode (control STOP) at the RUN/STOP transfer.*

* However, only checking can be made even in the RUN state.

 To change the parameters in the Engineering mode from F21 to F70, preset “128” to the mode selection at F00.

8.5.1 Display sequence

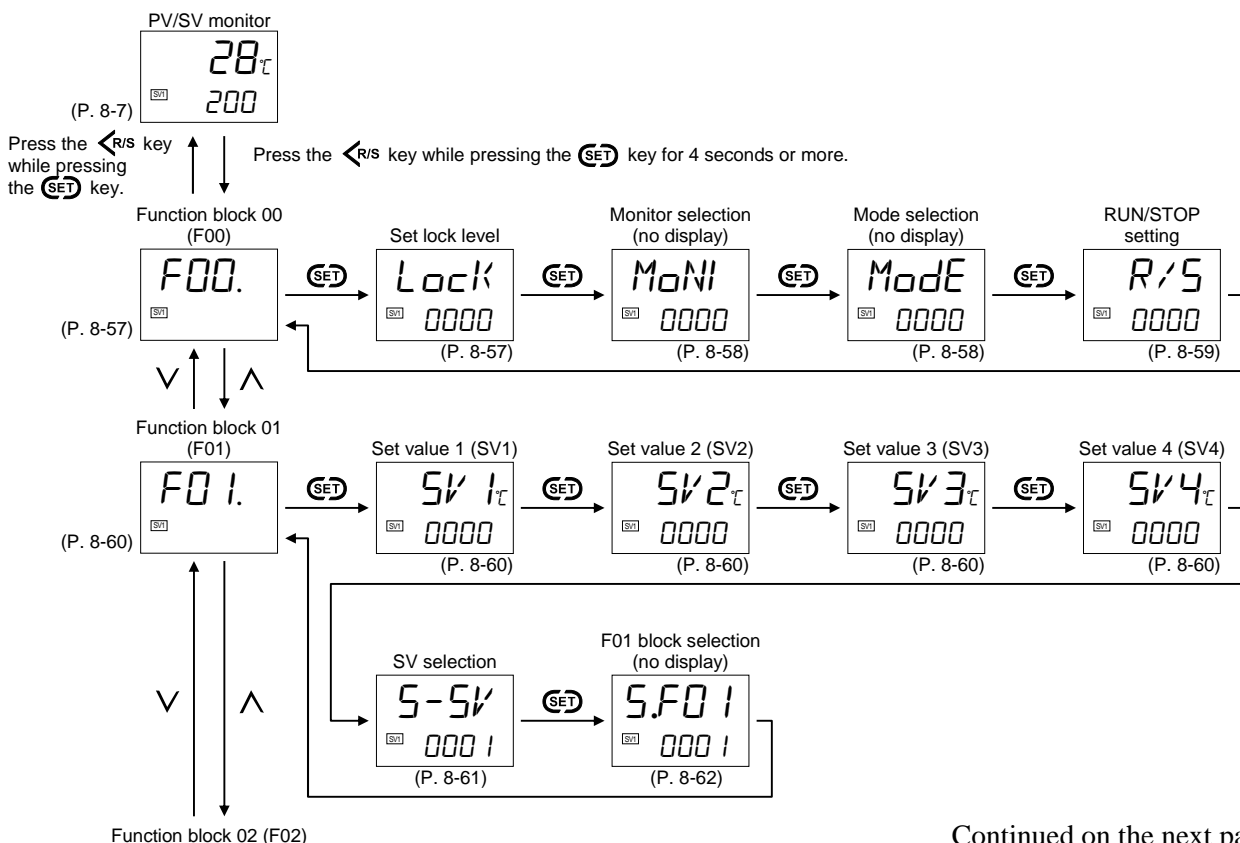

Continued on the next page.

Continued from the previous page.

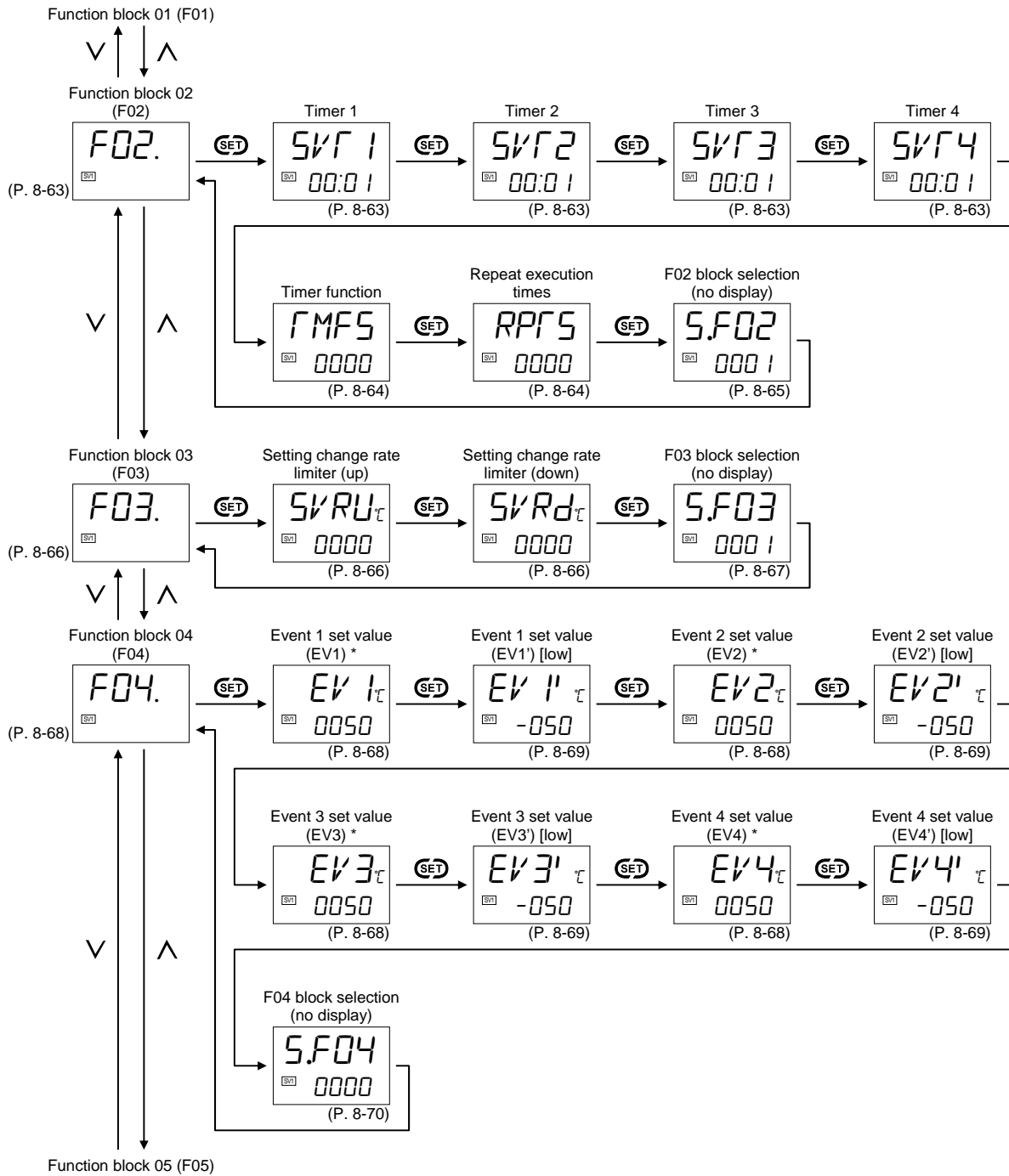

* If any of the following Event functions are selected, this parameter will be Event □ set value (EV□) [high].
 (Event number at parameter setting shows up in □.)

- Band (High/Low individual setting) [Event type code: U]
- Deviation high/low (High/Low individual setting) [Event type code: X]
- Deviation high/low with hold action (High/Low individual setting) [Event type code: Y]
- Deviation high/low with re-hold action (High/Low individual setting) [Event type code: Z]

Continued on the next page.

Continued from the previous page.

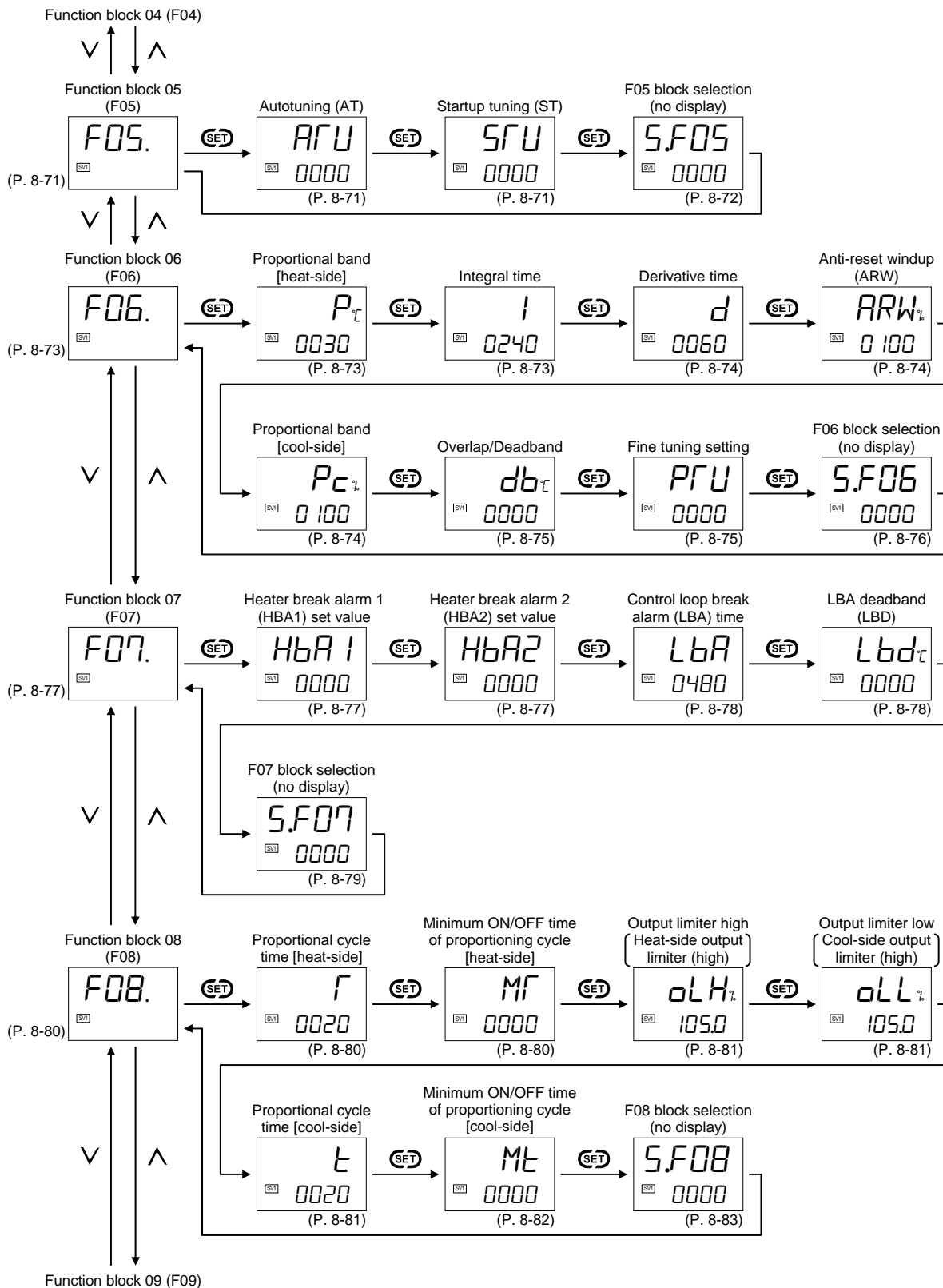

Continued on the next page.

Continued from the previous page.

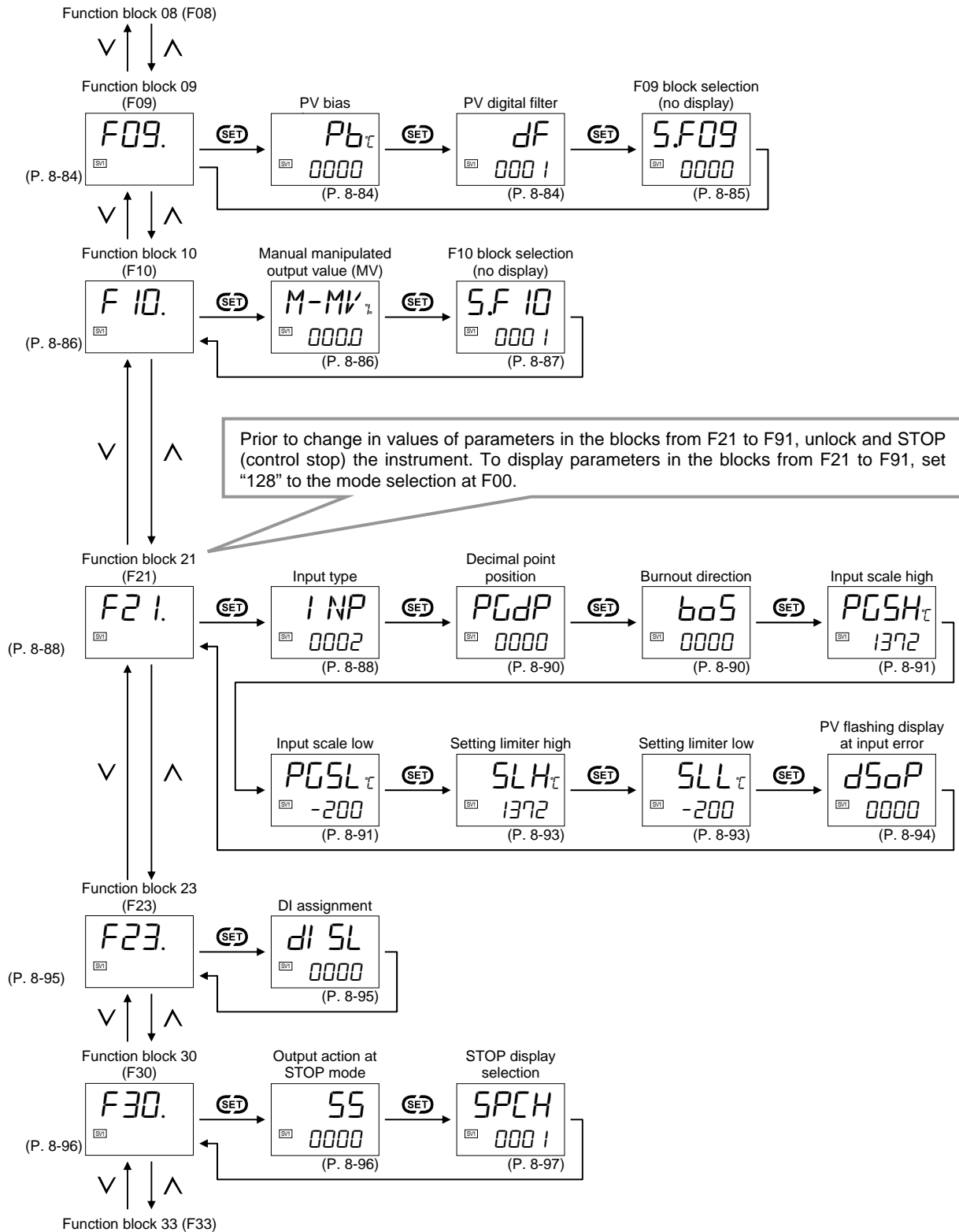

Continued on the next page.

Continued from the previous page.

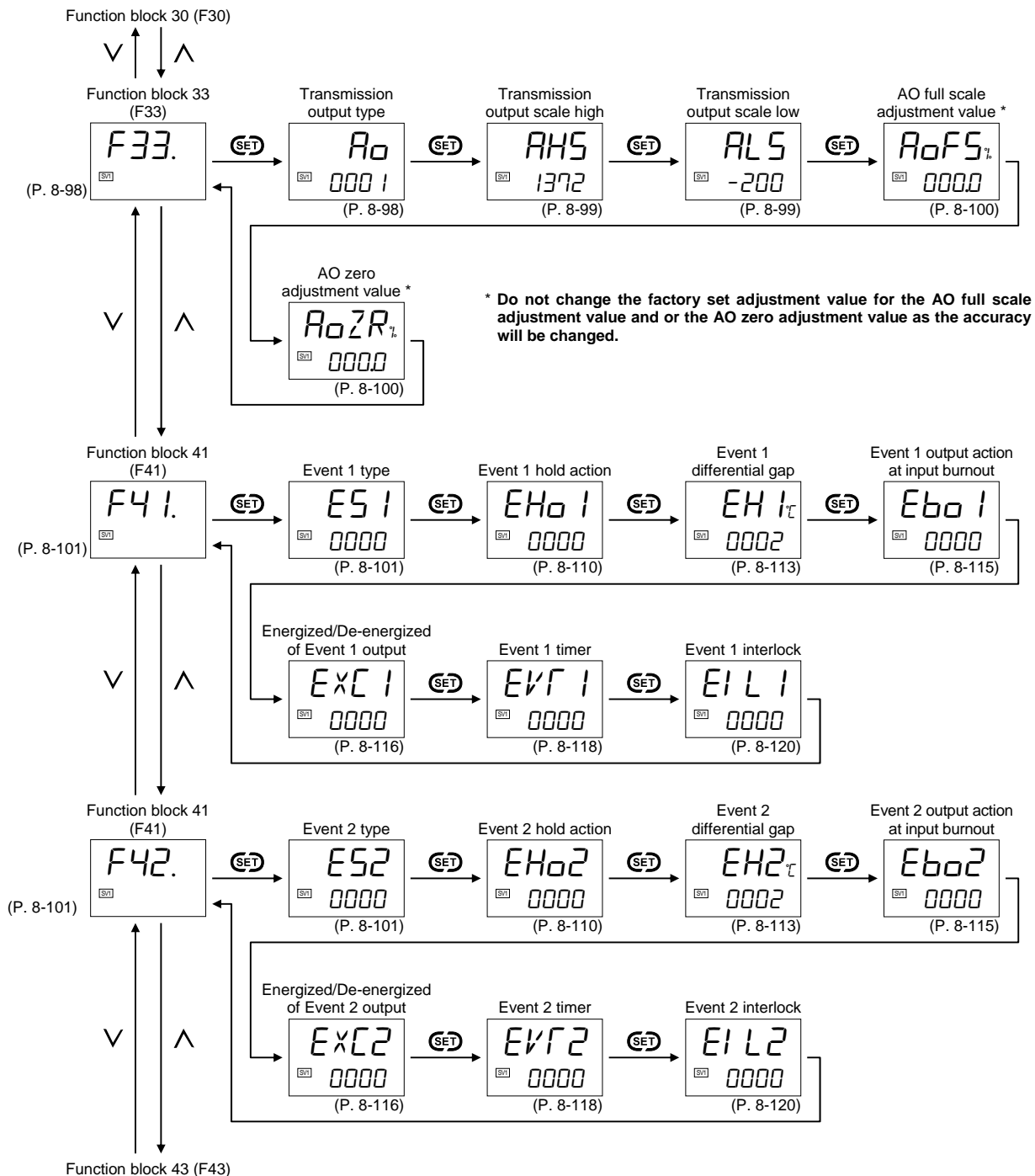

Continued on the next page.

Continued from the previous page.

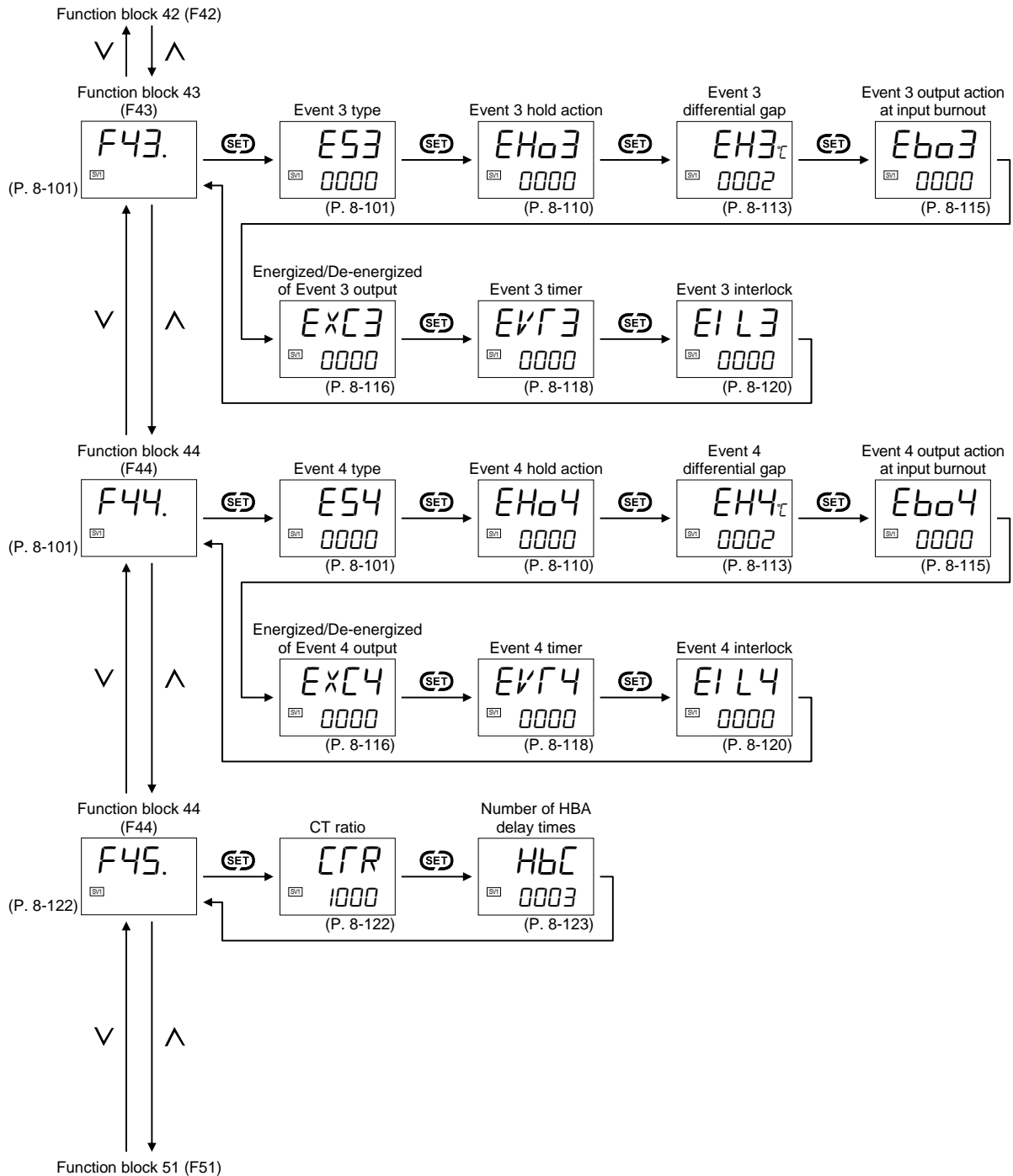

Continued on the next page.

Continued from the previous page.

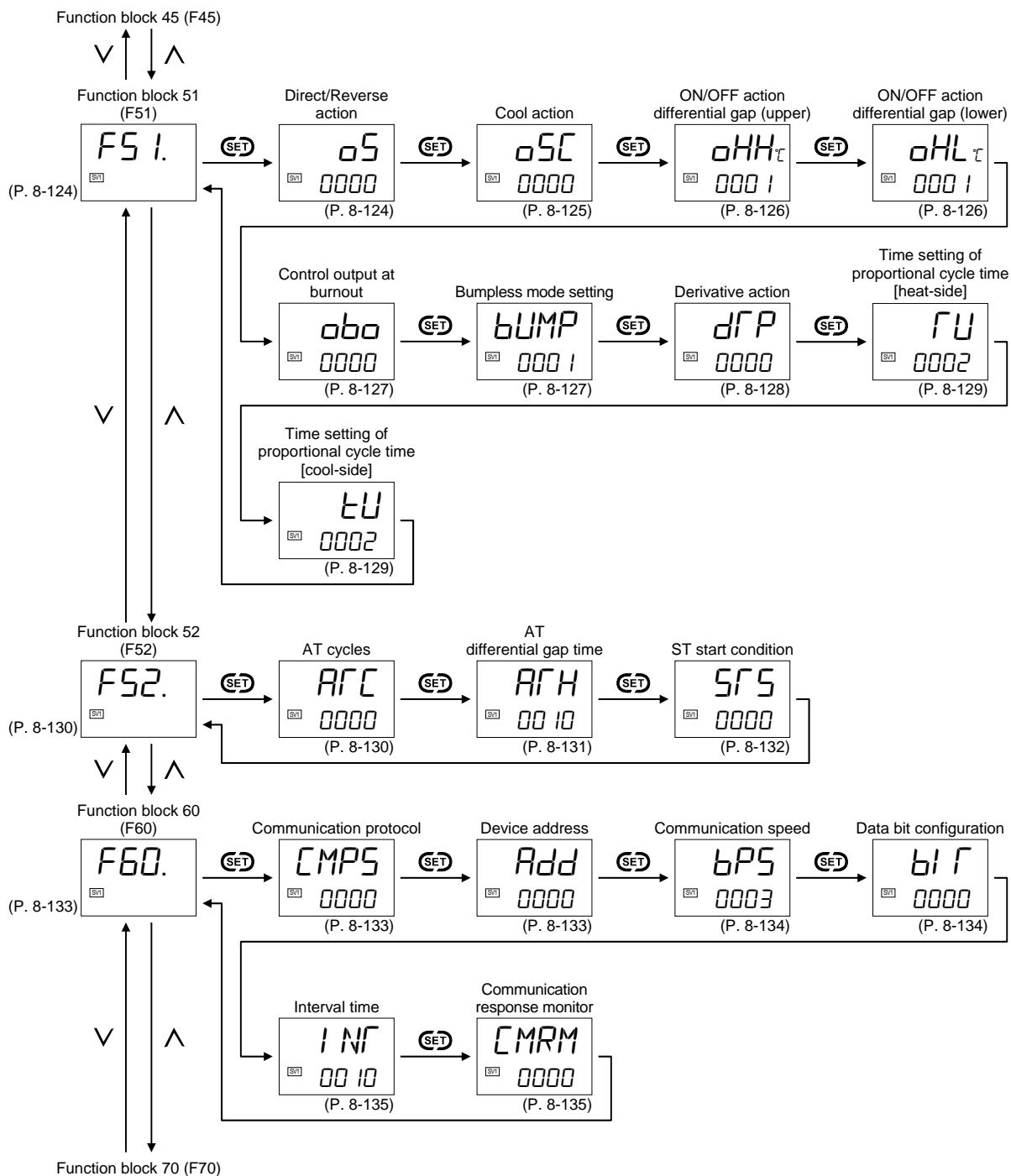

Continued on the next page.

Continued from the previous page.

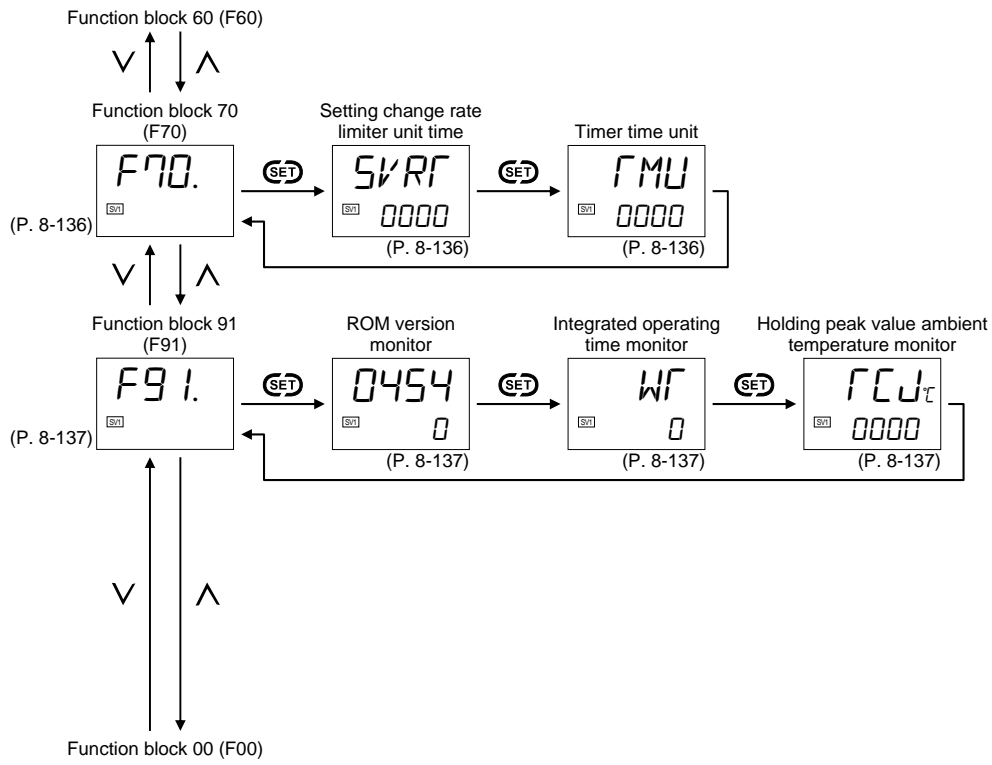

■ Function block (F□□) structure in the Engineering mode

Setting items are classified into groups (Function block: F□□) within the Engineering mode.

● Function block 00 (F00)

No display screen settings (Monitor display mode, Mode switching), set lock level settings for the Setting data lock function, and RUN/STOP switching in Engineering mode can be selected.

● Function block 01 (F01) to Function block 10 (F10)

The parameter setting screen that is displayed in Parameter setting mode can be hidden. Some setting items in Parameter setting mode are the same as the items in F01 to F10. When the set value of one of these items is changed, the set value of the corresponding item in the other mode also changes.

 If the setting data is locked, the data cannot be changed.

● Function block 21 (F21) to Function block 91 (F91)

Settings related to the specifications of this product can be selected.

Parameters from F21 to F91 are not displayed. To display these parameters, set “128” to the Mode selection (no display) [*ModE*] at F00.

 If the setting data is locked, the data cannot be changed.

Display or setting of parameters in F21 to F91 is not available when the setting data is locked.

 If the controller is RUN state, the data of F21 to F91 cannot be changed.

■ Restricting access to the Engineering mode

Access on display and setting is limited in the Engineering mode. When the setting data is locked by the Data lock function, the data is not displayed. Refer to the table below for access restrictions in the Engineering mode:

⊙: Can be displayed and change ○: Can be displayed ●: Cannot be displayed or change

Set data unlock/ lock transfer	Engineering mode	RUN/STOP	
		RUN	STOP (STOP lamp lights)
Unlock	F00	⊙	⊙
	F01 to F10	⊙	⊙
	F21 to F91	○	⊙ (Excluding F91)
Lock (L lamp lights)	F00	⊙	⊙
	F01 to F10 *	⊙	⊙
	F21 to F91	●	●

* Settings can be changed within the parameters in the unlocked function blocks.

8.5.2 Precaution against parameter change

If any of the following parameters are changed, the set values of relevant parameters are initialized or automatically converted according to the new setting. It may result in malfunction or failure of the instrument.

- Input type (*INP*)
- Transmission output type (*RO*)
- Event 1 type (*ES1*)
- Event 2 type (*ES2*)
- Event 3 type (*ES3*)
- Event 4 type (*ES4*)
- Output limiter high (*OLH*)
- Output limiter low (*OLL*)
- Decimal point position (*PCdP*)
- Input scale high (*PCSH*)
- Input scale low (*PCSL*)
- Setting limiter high (*SLH*)
- Setting limiter low (*SLL*)
- Communication protocol (*CMPS*)
- Timer time unit (*FMU*)



Before changing any parameter setting on the above list, always record all parameter settings in SV setting mode, Parameter setting mode and Engineering mode. And after the change, always check all parameter settings in SV setting mode, Parameter setting mode and Engineering mode by comparing them with the record taken before the change.

■ When Input type (INP) is changed

The following parameter will be changed to factory default values according to the new setting.

Item	Default value	Item	Default value	
Decimal point position	TC/RTD inputs: Without decimal point: 0 With decimal point: 1 Voltage (V)/Current (I) inputs: 1	Proportional band [cool-side]	100 % of Proportional band [heat-side]	
		Fine tuning setting	0	
Input scale high	TC/RTD inputs: Maximum value of the selected input range Voltage (V)/Current (I) inputs: 100.0	Overlap/Deadband	TC/RTD inputs: 0 (0.0) °C [°F] Voltage (V)/Current (I) inputs: 0.0 % of Input span	
Input scale low	TC/RTD inputs: Minimum value of the selected input range Voltage (V)/Current (I) inputs: 0.0	PV bias	TC/RTD inputs: 0 (0.0) °C [°F] Voltage (V)/Current (I) inputs: 0.0	
Setting limiter high	Input scale high	PV digital filter	1	
Setting limiter low	Input scale low	Control loop break alarm (LBA) time	480 seconds	
Set value 1 (SV1)	TC/RTD inputs: 0 (0.0) °C [°F] Voltage (V)/Current (I) inputs: 0.0	LBA deadband (LBD)	0	
Set value 2 (SV2)		Event 1 set value (EV1)	TC/RTD inputs: 50 (50.0) °C [°F] Voltage (V)/Current (I) inputs: 5.0	
Set value 3 (SV3)		Event 2 set value (EV2)		
Set value 4 (SV4)		Event 3 set value (EV3)		
		Event 4 set value (EV4)		
Setting change rate limiter (up)	0 (0.0) °C [°F]	Event 1 set value (EV1) [high]	TC/RTD inputs: 50 (50.0) °C [°F] Voltage (V)/Current (I) inputs: 5.0	
Setting change rate limiter (down)	0 (0.0) °C [°F]	Event 2 set value (EV2) [high]		
ON/OFF action differential gap (upper)	TC/RTD inputs: 1 (1.0) °C [°F] Voltage (V)/Current (I) inputs: 0.1 % of Input span	Event 3 set value (EV3) [high]		
ON/OFF action differential gap (lower)	TC/RTD inputs: 1 (1.0) °C [°F] Voltage (V)/Current (I) inputs: 0.1 % of Input span	Event 4 set value (EV4) [high]		
Proportional band [heat-side]	TC/RTD inputs: 30 (30.0) °C [°F] Voltage (V)/Current (I) inputs: 3.0 % of Input span	Event 1 set value (EV1') [low]	TC/RTD inputs: -50 (-50.0) °C [°F] Voltage (V)/Current (I) inputs: -5.0	
Integral time		240 seconds		Event 2 set value (EV2') [low]
Derivative time		60 seconds		Event 3 set value (EV3') [low]
Anti-reset windup (ARW)		100 % of Proportional band [heat-side]		Event 4 set value (EV4') [low]

Continued on the next page.

Item	Default value	Item	Default value
Event 1 differential gap	TC/RTD inputs: 2 (2.0) °C [°F] Voltage (V)/Current (I) inputs: 0.2	Event 1 timer	0 seconds
Event 2 differential gap		Event 2 timer	
Event 3 differential gap		Event 3 timer	
Event 4 differential gap		Event 4 timer	
Event 1 hold action	0	Transmission output scale high	High-limit value of input span
Event 2 hold action		Transmission output scale low	Low-limit value of input span
Event 3 hold action			
Event 4 hold action			

■ When Transmission output type (Ao) is changed

The following parameter will be changed to factory default values according to the new setting.

Item	Default value	Item	Default value
Transmission output scale high	High-limit value of input span	Transmission output scale low	Low-limit value of input span

■ When Event 1 type (ES1) is changed

The following parameter will be changed to factory default values according to the new setting.

Item	Default value	Item	Default value
Event 1 set value (EV1)	TC/RTD inputs: 50 (50.0) °C [°F] Voltage (V)/Current (I) inputs: 5.0	Event 1 differential gap	TC/RTD inputs: 2 (2.0) °C [°F] Voltage (V)/Current (I) inputs: 0.2
Event 1 set value (EV1) [high]	TC/RTD inputs: 50 (50.0) °C [°F] Voltage (V)/Current (I) inputs: 5.0	Event 1 hold action	0
Event 1 set value (EV1') [low]	TC/RTD inputs: -50 (-50.0) °C [°F] Voltage (V)/Current (I) inputs: -5.0	Event 1 timer	0 seconds

■ When Event 2 type (ES2) is changed

The following parameter will be changed to factory default values according to the new setting.

Item	Default value	Item	Default value
Event 2 set value (EV2)	TC/RTD inputs: 50 (50.0) °C [°F] Voltage (V)/Current (I) inputs: 5.0	Event 2 differential gap	TC/RTD inputs: 2 (2.0) °C [°F] Voltage (V)/Current (I) inputs: 0.2
Event 2 set value (EV2) [high]	TC/RTD inputs: 50 (50.0) °C [°F] Voltage (V)/Current (I) inputs: 5.0	Event 2 hold action	0
Event 2 set value (EV2') [low]	TC/RTD inputs: -50 (-50.0) °C [°F] Voltage (V)/Current (I) inputs: -5.0	Event 2 timer	0 seconds

■ When Event 3 type (ES3) is changed

The following parameter will be changed to factory default values according to the new setting.

Item	Default value	Item	Default value
Event 3 set value (EV3)	TC/RTD inputs: 50 (50.0) °C [°F] Voltage (V)/Current (I) inputs: 5.0	Event 3 differential gap	TC/RTD inputs: 2 (2.0) °C [°F] Voltage (V)/Current (I) inputs: 0.2
Event 3 set value (EV3) [high]	TC/RTD inputs: 50 (50.0) °C [°F] Voltage (V)/Current (I) inputs: 5.0	Event 3 hold action	0
Event 3 set value (EV3') [low]	TC/RTD inputs: -50 (-50.0) °C [°F] Voltage (V)/Current (I) inputs: -5.0	Event 3 timer	0 seconds

■ When Event 4 type (ES4) is changed

The following parameter will be changed to factory default values according to the new setting.

Item	Default value	Item	Default value
Event 4 set value (EV4)	TC/RTD inputs: 50 (50.0) °C [°F] Voltage (V)/Current (I) inputs: 5.0	Event 4 differential gap	TC/RTD inputs: 2 (2.0) °C [°F] Voltage (V)/Current (I) inputs: 0.2
Event 4 set value (EV4) [high]	TC/RTD inputs: 50 (50.0) °C [°F] Voltage (V)/Current (I) inputs: 5.0	Event 4 hold action	0
Event 4 set value (EV4') [low]	TC/RTD inputs: -50 (-50.0) °C [°F] Voltage (V)/Current (I) inputs: -5.0	Event 4 timer	0 seconds

■ When Output limiter high [oLH] is changed

The following parameter will be automatically converted.

- Manual manipulated output value (MV)
- Output limiter low

■ When Output limiter low [oLL] is changed

The following parameter will be automatically converted.

- Manual manipulated output value (MV)
- Output limiter high

■ When Decimal point position (PGdP) is changed

The following parameter will be automatically converted.

- Input scale high
- Input scale low
- Setting limiter high
- Setting limiter low
- Set value 1 (SV1)
- Set value 2 (SV2)
- Set value 3 (SV3)
- Set value 4 (SV4)
- Setting change rate limiter (up)
- Setting change rate limiter (down)
- Proportional band [heat-side]
- Overlap/Deadband
- PV bias
- LBA deadband (LBD)
- Event 1 set value (EV1)
- Event 1 set value (EV1) [high]
- Event 1 set value (EV1') [low]
- Event 1 differential gap
- Event 2 set value (EV2)
- Event 2 set value (EV2) [high]
- Event 2 set value (EV2') [low]
- Event 2 differential gap
- Event 3 set value (EV3)
- Event 3 set value (EV3) [high]
- Event 3 set value (EV3') [low]
- Event 3 differential gap
- Event 4 set value (EV4)
- Event 4 set value (EV4) [high]
- Event 4 set value (EV4') [low]
- Event 4 differential gap
- Transmission output scale high
- Transmission output scale low

■ When Input scale high (PGSH) is changed

The following parameter will be automatically converted.

- Input scale low
- Setting limiter high
- Setting limiter low
- Set value 1 (SV1)
- Set value 2 (SV2)
- Set value 3 (SV3)
- Set value 4 (SV4)
- Setting change rate limiter (up)
- Setting change rate limiter (down)
- Proportional band [heat-side]
- LBA deadband (LBD)
- Event 1 set value (EV1)
- Event 1 set value (EV1) [high]
- Event 1 set value (EV1') [low]
- Event 1 differential gap
- Event 2 set value (EV2)
- Event 2 set value (EV2) [high]
- Event 2 set value (EV2') [low]
- Event 2 differential gap
- Event 3 set value (EV3)
- Event 3 set value (EV3) [high]
- Event 3 set value (EV3') [low]
- Event 3 differential gap
- Event 4 set value (EV4)
- Event 4 set value (EV4) [high]
- Event 4 set value (EV4') [low]
- Event 4 differential gap
- Transmission output scale high
- Transmission output scale low

■ When Input scale low (PGSL) is changed

The following parameter will be automatically converted.

- Input scale high
- Setting limiter high
- Setting limiter low
- Set value 1 (SV1)
- Set value 2 (SV2)
- Set value 3 (SV3)
- Set value 4 (SV4)
- Setting change rate limiter (up)
- Setting change rate limiter (down)
- Proportional band [heat-side]
- LBA deadband (LBD)
- Event 1 set value (EV1)
- Event 1 set value (EV1) [high]
- Event 1 set value (EV1') [low]
- Event 1 differential gap
- Event 2 set value (EV2)
- Event 2 set value (EV2) [high]
- Event 2 set value (EV2') [low]
- Event 2 differential gap
- Event 3 set value (EV3)
- Event 3 set value (EV3) [high]
- Event 3 set value (EV3') [low]
- Event 3 differential gap
- Event 4 set value (EV4)
- Event 4 set value (EV4) [high]
- Event 4 set value (EV4') [low]
- Event 4 differential gap
- Transmission output scale high
- Transmission output scale low

■ When Setting limiter high [SLH] is changed

The following parameter will be automatically converted.

- Setting limiter low
- Set value 1 (SV1)
- Set value 2 (SV2)
- Set value 3 (SV3)
- Set value 4 (SV4)

■ When Setting limiter low [SLL] is changed

The following parameter will be automatically converted.

- Setting limiter high
- Set value 1 (SV1)
- Set value 2 (SV2)
- Set value 3 (SV3)
- Set value 4 (SV4)

■ When Communication protocol (CMPS) is changed

The following parameter will be automatically converted.

- Device address
- Data bit configuration

■ When Timer time unit (TMU) is changed

The following parameter will be automatically converted.

- Timer 1
- Timer 2
- Timer 3
- Timer 4

■ **Example of automatic conversion**

- Decimal point position moves in accordance with the setting change.

Example: When the setting of the Decimal point position (*PGdP*) is changed from 1 (One decimal place) to 0 (no decimal place) with Input scale high (*PGSH*) set to 400.0 °C:



Digits to the right of the decimal point are rounded off.

- Values of parameters related to Input scale high (*PGSH*) change automatically in accordance with the change in value of Input scale high (*PGSH*).

Example: When Input scale high (*PGSH*) changes from 400.0 °C to 200.0 °C



The value of the Setting limiter high automatically changes to 200.0 °C.

- Values of parameters related to Communication protocol selection (*EMPS*) automatically in accordance with the change from RKC communication to Modbus.

Example 1: When Device address is “0”



For Modbus, the Device address automatically sets to “1” as address number “0” is not available in Modbus.

Example 2: When the Data bit configuration is “7 (data 8-bit, without parity, stop 2-bit)”



For Modbus, the data bit configuration automatically changes to “0 (data 8-bit, without parity, stop 1 bit)” as the data bit 7 is not available in Modbus.

8.5.3 Engineering setting item

Function block 00 (F00)

F00.

This is the first parameter symbol of Function block 00 (F00).

F00

Set lock level

Lock

Lock and protect set data of parameters in each parameter group.

Data range	Factory set value
0: All parameters can be changed	0
1: Lock "Parameter Group" F01 through F10	
2: Lock "Parameter Group" F02 through F10	
3: Lock "Parameter Group" F03 through F10	
4: Lock "Parameter Group" F04 through F10	
5: Lock "Parameter Group" F05 through F10	
6: Lock "Parameter Group" F06 through F10	
7: Lock "Parameter Group" F07 through F10	
8: Lock "Parameter Group" F08 through F10	
9: Lock "Parameter Group" F09 and F10	
10: Lock "Parameter Group" F10	

Related parameter

Mode switching:

- Set data unlock/lock transfer (P. 8-10)

■ Description of function

The same parameters exist in Parameter setting mode and Engineering mode F01 to F10. Parameters are grouped into F01 to F10 blocks to lock set data per related parameters. Set data is locked by Setting data unlock/lock transfer in each Function blocks from F01 to F10. The same parameters will also be locked in Parameter setting mode.

 For details of setting method, refer to **6.6 Protecting Setting Data (P. 6-24)**.

F00

Monitor selection (no display)

MONI

Hide parameters in the Monitor display mode. To select more than one parameter, set the total value of the parameters.

Data range	Factory set value
0: Display all	0
1: Current transformer 1 (CT1) input value monitor [no display]	
2: Current transformer 2 (CT2) input value monitor [no display]	
4: Manipulated output value (MV) monitor [no display]	
8: Remaining time monitor [no display]	

 PV/SV monitor cannot be set to “no display.”

 For details of setting method, refer to **6.7 Display/No display Setting of Mode Screens (P. 6-32, P. 6-34)**.

F00

Mode selection (no display)

MODE

Hide Mode switching screens at the Mode switching. To select more than one Mode switching screens, set the total value of the Mode switching screens. This parameter can also be used to prohibit RUN/STOP transfer with the <R/S key and display F21 to F91 of Engineering mode.

Data range	Factory set value
0: Display Mode switching screen (Auto/Manual transfer, Set data unlock/lock transfer, Interlock release)	0
1: Auto (AUTO)/Manual (MAN) transfer [no display]	
2: Set data unlock/lock transfer [no display]	
4: Interlock release [no display]	
8: Disable <R/S key operation	
128: Display F21 to F91 Engineering mode.	

 For details of setting method, refer to **6.7 Display/No display Setting of Mode Screens (P. 6-32, P. 6-35)**.

F00

RUN/STOP setting

R/S

RUN/STOP transfer is can be set in the Engineering mode state. Select RUN or STOP and press the  key.

Data range	Factory set value
0: RUN	0
1: STOP (STOP lamp lights)	





Set RUN mode “0: RUN” prior to transfer RUN/STOP mode by digital input (DI).

Relations between key operations/communication and DI status

Mode select from key operation or communication		DI-switched *	Actual state
RUN/STOP transfer or RUN/STOP setting	RUN	RUN (Contact closed)	RUN
		STOP (Contact open)	STOP
	STOP	RUN (Contact closed)	
		STOP (Contact open)	

* When digital input (DI) is used for transfer, the new state is not backed up to EEPROM.



RUN/STOP setting links to the operation by  key. When RUN/STOP mode is transferred by  key, the set data of RUN/STOP setting is also transferred.

Function block 01 (F01)



This is the first parameter symbol of Function block 01 (F01).

F01.

Set value 1 (SV1)

Set value 2 (SV2)

Set value 3 (SV3)

Set value 4 (SV4)

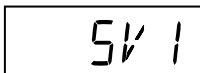

Link to the set values SV1 to SV4 of Parameter setting mode and the Set values (SV) of SV setting mode.

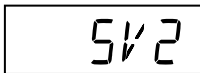

 For details of Set value SV1 to SV4, refer to **8.4.2 Parameter setting item (P. 8-13)**.

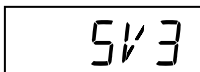

Related parameter

SV setting mode:

- Measured value (PV)/Set value (SV) (P. 8-7)

Parameter setting mode:

- Set value 1 (SV1), Set value 2 (SV2), Set value 3 (SV3), and Set value 4 (SV4) (P. 8-13)
- SV selection (P. 8-14)
- Timer 1, Timer 2, Timer 3, and Timer 4 (P. 8-15)
- Timer function (P. 8-16)
- Repeat execution times (P. 8-17)
- Setting change rate limiter (up), Setting change rate limiter (down) (P. 8-18)

Engineering mode:

- SV selection (P. 8-61)
- Timer 1, Timer 2, Timer 3, and Timer 4 (P. 8-63)
- Timer function (P. 8-64)
- Repeat execution times (P. 8-64)
- Setting change rate limiter (up), Setting change rate limiter (down) (P. 8-66)
- Setting limiter high (P. 8-93)
- Setting limiter low (P. 8-93)

F01

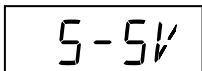
SV selection

Link to the SV selection in Parameter setting mode.

- For details of SV selection, refer to **8.4.2 Parameter setting item (P. 8-14)**.

Related parameter

SV setting mode:

- Measured value (PV)/Set value (SV) (P. 8-7)

Parameter setting mode:

- Set value 1 (SV1), Set value 2 (SV2), Set value 3 (SV3), and Set value 4 (SV4) (P. 8-13)
- SV selection (P. 8-14)

Engineering mode:

- Set value 1 (SV1), Set value 2 (SV2), Set value 3 (SV3), and Set value 4 (SV4) (P. 8-60)

F01

F01 block selection (no display)



Hide parameter symbols of the Parameter setting mode from the display.

Data range	Factory set value
0: Display 1: No display	1

When “No display” is selected, the parameters of Parameter setting mode are not displayed; however, F01 parameters are displayed.

For details of setting example, refer to **6.7 Display/No display Setting of Mode Screens (P. 6-32, P. 6-37)**.

Related parameter

Parameter setting mode:

- Set value 1 (SV1), Set value 2 (SV2), Set value 3 (SV3), and Set value 4 (SV4) (P. 8-13)
- SV selection (P. 8-14)

■ Description of function

Hide parameters of the Parameter setting mode from the display. Each parameter of Parameter setting mode link to the Engineering mode from F01 to F10. The parameters of the Parameter setting mode linked to the parameters of the Engineering mode is not displayed when “No display” is set to F01 block selection. Those parameters of the Parameter setting mode link to F01 block of the Engineering mode.

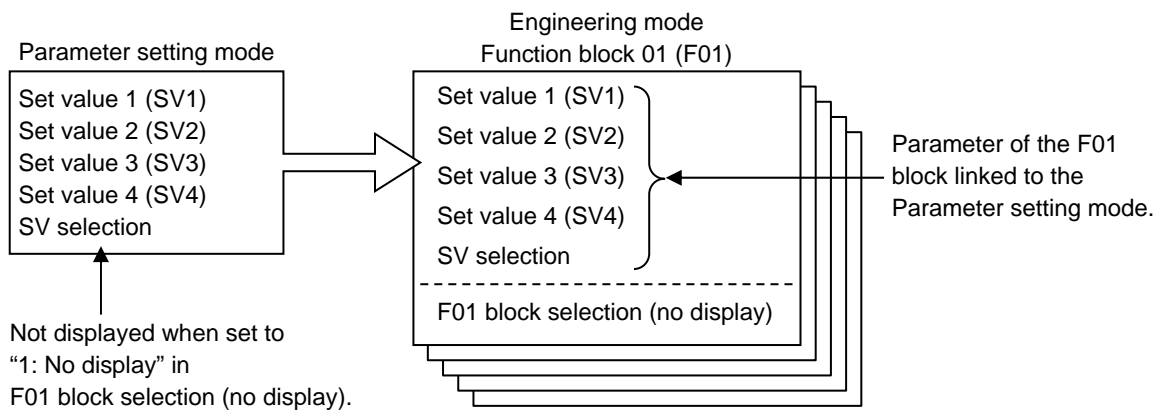

Function block 02 (F02)



This is the first parameter symbol of Function block 02 (F02).

F02

Timer 1

Timer 2

Timer 3

Timer 4



Link to Timer 1, 2, 3 or 4 in the Parameter setting mode.

 For details of Timer 1 to Timer 4, refer to **8.4.2 Parameter setting item (P. 8-15)**.

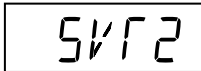
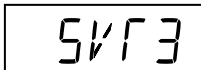
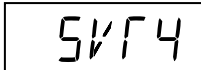
Related parameter

Parameter setting mode:

- Timer 1, Timer 2, Timer 3, and Timer 4 (P. 8-15)
- Timer function (P. 8-16)
- Repeat execution times (P. 8-17)
- Setting change rate limiter (up), Setting change rate limiter (down) (P. 8-18)

Engineering mode:

- Timer function (P. 8-64)
- Repeat execution times (P. 8-64)
- Setting change rate limiter (up), Setting change rate limiter (down) (P. 8-66)

F02

Timer function



Link to the Timer function in the Parameter setting mode.

 For details of Timer function, refer to **8.4.2 Parameter setting item (P. 8-16)**.

Related parameter

Parameter setting mode:

- Timer 1, Timer 2, Timer 3, and Timer 4 (P. 8-15)
- Timer function (P. 8-16)
- Repeat execution times (P. 8-17)
- Setting change rate limiter (up), Setting change rate limiter (down) (P. 8-18)

Engineering mode:

- Timer 1, Timer 2, Timer 3, and Timer 4 (P. 8-63)
- Repeat execution times (P. 8-64)
- Setting change rate limiter (up), Setting change rate limiter (down) (P. 8-66)

F02

Repeat execution times



Link to the Repeat execution times in the Parameter setting mode.

 For details of Repeat execution times, refer to **8.4.2 Parameter setting item (P. 8-17)**.

Related parameter

Parameter setting mode:

- Timer 1, Timer 2, Timer 3, and Timer 4 (P. 8-15)
- Timer function (P. 8-16)
- Repeat execution times (P. 8-17)
- Setting change rate limiter (up), Setting change rate limiter (down) (P. 8-18)

Engineering mode:

- Timer 1, Timer 2, Timer 3, and Timer 4 (P. 8-63)
- Timer function (P. 8-64)
- Setting change rate limiter (up), Setting change rate limiter (down) (P. 8-66)

F02

F02 block selection (no display)

Hide parameter symbols of in the Parameter setting mode from the display.

Data range	Factory set value
0: Display 1: No display	1

When “No display” is selected, the parameters of Parameter setting mode are not displayed; however, F02 parameters are displayed.

For details of setting example, refer to **6.7 Display/No display Setting of Mode Screens (P. 6-32, P. 6-37)**.

Related parameter

Parameter setting mode:

- Timer 1, Timer 2, Timer 3, and Timer 4 (P. 8-15)
- Timer function (P. 8-16)
- Repeat execution times (P. 8-17)

■ Description of function

Hide parameters of the Parameter setting mode from the display. Each parameter of Parameter setting mode link to the Engineering mode from F01 to F10. The parameters of the Parameter setting mode linked to the parameters of the Engineering mode is not displayed when “No display” is set to F02 block selection. Those parameters of the Parameter setting mode link to F02 block of the Engineering mode.

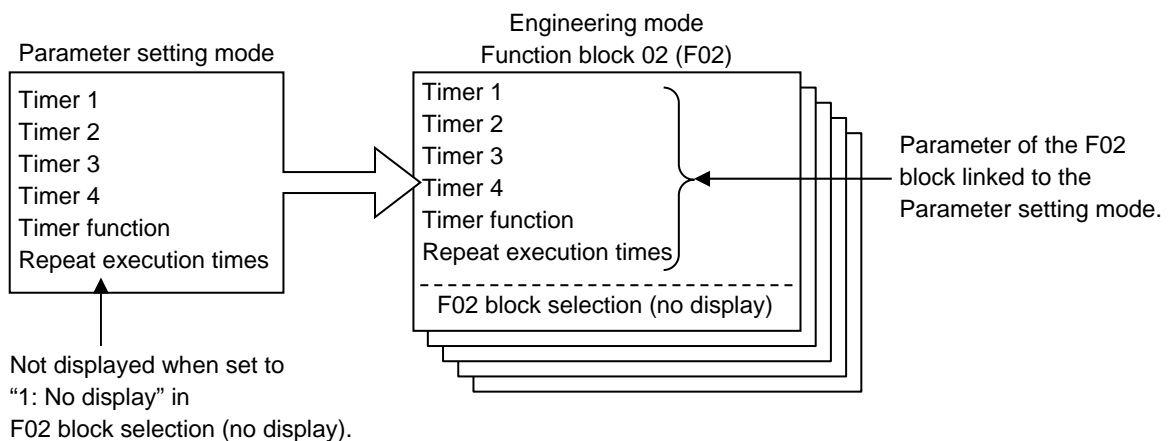

Function block 03 (F03)



This is the first parameter symbol of Function block 03 (F03).

F03

Setting change rate limiter (up)

Setting change rate limiter (down)



Link to the Setting change rate limiter in Parameter setting mode.

☞ For details of Setting change rate limiter (up) and Setting change rate limiter (down), refer to **8.4.2 Parameter setting item (P. 8-18)**.



Related parameter

Parameter setting mode:

- Set value 1 (SV1), Set value 2 (SV2), Set value 3 (SV3), and Set value 4 (SV4) (P. 8-13)
- SV selection (P. 8-14)
- Timer 1, Timer 2, Timer 3, and Timer 4 (P. 8-15)
- Timer function (P. 8-16)
- Repeat execution times (P. 8-17)
- Setting change rate limiter (up), Setting change rate limiter (down) (P. 8-18)

Engineering mode:

- Set value 1 (SV1), Set value 2 (SV2), Set value 3 (SV3), and Set value 4 (SV4) (P. 8-60)
- SV selection (P. 8-61)
- Timer 1, Timer 2, Timer 3, and Timer 4 (P. 8-63)
- Timer function (P. 8-64)
- Repeat execution times (P. 8-64)

F03

F03 block selection (no display)

SF03

Hide parameter symbols of in the Parameter setting mode from the display.

Data range	Factory set value
0: Display 1: No display	1

 When “No display” is selected, the parameters of Parameter setting mode are not displayed; however, F03 parameters are displayed.

 For details of setting example, refer to **6.7 Display/No display Setting of Mode Screens (P. 6-32, P. 6-37)**.

Related parameter

Parameter setting mode:

- Setting change rate limiter (up), Setting change rate limiter (down) (P. 8-18)

■ Description of function

Hide parameters of the Parameter setting mode from the display. Each parameter of Parameter setting mode link to the Engineering mode from F01 to F10. The parameters of the Parameter setting mode linked to the parameters of the Engineering mode is not displayed when “No display” is set to F03 block selection. Those parameters of the Parameter setting mode link to F03 block of the Engineering mode.

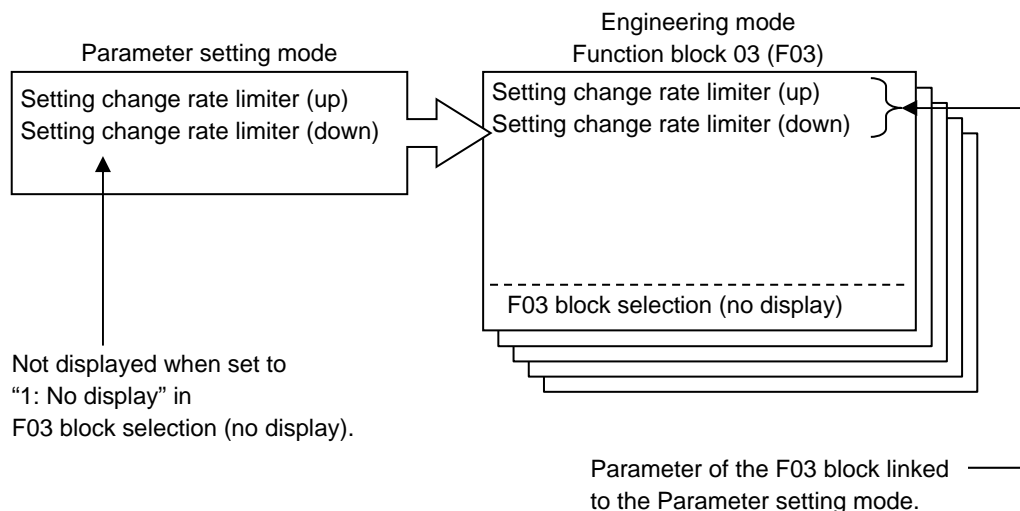

Function block 04 (F04)



This is the first parameter symbol of Function block 04 (F04).

F04

Event 1 set value (EV1), Event 1 set value (EV1) [high]

Event 2 set value (EV2), Event 2 set value (EV2) [high]

Event 3 set value (EV3), Event 3 set value (EV3) [high]

Event 4 set value (EV4), Event 4 set value (EV4) [high]

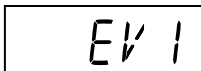

Link to the Event 1 to Event 4 set value [high] of in the Parameter setting mode.

☞ For details of Event 1 set value (EV1) <Event 1 set value (EV1) [high]> to Event 4 set value (EV4) <Event 4 set value (EV4) [high]>, refer to **8.4.2 Parameter setting item (P. 8-20)**.

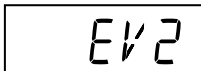
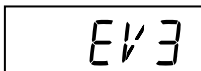
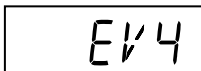
Related parameter

Parameter setting mode:

- Event 1 set value (EV1) <Event 1 set value (EV1) [high]> to Event 4 set value (EV4) <Event 4 set value (EV4) [high]> (P. 8-20)
- Event 1 set value (EV1') [low] to Event 4 set value (EV4') [low] (P. 8-22)

Engineering mode:

- Event 1 set value (EV1') [low] to Event 4 set value (EV4') [low] (P. 8-69)
- Event 1 type to Event 4 type (P. 8-101)
- Event 1 hold action to Event 4 hold action (P. 8-110)
- Event 1 differential gap to Event 4 differential gap (P. 8-113)
- Event 1 output action at input burnout to Event 4 output action at input burnout (P. 8-115)
- Energized/De-energized of Event 1 output to Energized/De-energized of Event 4 output (P. 8-116)
- Event 1 timer to Event 4 timer (P. 8-118)
- Event 1 interlock to Event 4 interlock (P. 8-120)

F04

Event 1 set value (EV1') [low]**Event 2 set value (EV2') [low]****Event 3 set value (EV3') [low]****Event 4 set value (EV4') [low]**

EV 1'

EV 2'

EV 3'

EV 4'

Link to the Event 1 to Event 4 set value [low] in the Parameter setting mode.

 For details of Event 1 set value (EV1') [low] to Event 4 set value (EV4') [low], refer to **8.4.2 Parameter setting item (P. 8-22)**.

Related parameter

Parameter setting mode:

- Event 1 set value (EV1) <Event 1 set value (EV1) [high]> to Event 4 set value (EV4) <Event 4 set value (EV4) [high]> (P. 8-20)
- Event 1 set value (EV1') [low] to Event 4 set value (EV4') [low] (P. 8-22)

Engineering mode:

- Event 1 set value (EV1) <Event 1 set value (EV1) [high]> to Event 4 set value (EV4) <Event 4 set value (EV4) [high]> (P. 8-68)
- Event 1 type to Event 4 type (P. 8-101)
- Event 1 hold action to Event 4 hold action (P. 8-110)
- Event 1 differential gap to Event 4 differential gap (P. 8-113)
- Event 1 output action at input burnout to Event 4 output action at input burnout (P. 8-115)
- Energized/De-energized of Event 1 output to Energized/De-energized of Event 4 output (P. 8-116)
- Event 1 timer to Event 4 timer (P. 8-118)
- Event 1 interlock to Event 4 interlock (P. 8-120)

F04

F04 block selection (no display)



Hide parameter symbols of in the Parameter setting mode from the display.

Data range	Factory set value
0: Display 1: No display	0

When “No display” is selected, the parameters of Parameter setting mode are not displayed; however, F04 parameters are displayed.

For details of setting example, refer to **6.7 Display/No display Setting of Mode Screens (P. 6-32, P. 6-37)**.

Related parameter

Parameter setting mode:

- Event 1 set value (EV1) <Event 1 set value (EV1) [high]> to Event 4 set value (EV4) <Event 4 set value (EV4) [high]> (P. 8-20)
- Event 1 set value (EV1') [low] to Event 4 set value (EV4') [low] (P. 8-22)

Engineering mode:

- Event 1 set value (EV1) <Event 1 set value (EV1) [high]> to Event 4 set value (EV4) <Event 4 set value (EV4) [high]> (P. 8-68)
- Event 1 set value (EV1') [low] to Event 4 set value (EV4') [low] (P. 8-69)

■ Description of function

Hide parameters of the Parameter setting mode from the display. Each parameter of Parameter setting mode link to the Engineering mode from F01 to F10. The parameters of the Parameter setting mode linked to the parameters of the Engineering mode is not displayed when “No display” is set to F04 block selection. Those parameters of the Parameter setting mode link to F04 block of the Engineering mode.

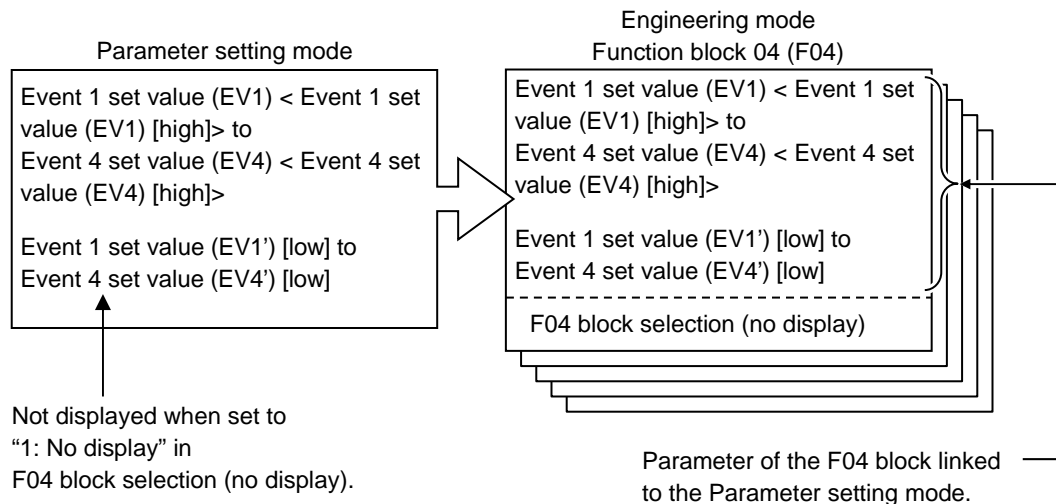

Function block 05 (F05)

A rectangular box containing the text "F05." in a monospaced font.

This is the first parameter symbol of Function block 05 (F05).

F05

Autotuning (AT)

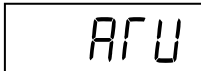
A rectangular box containing the text "ATU" in a monospaced font.

Link to the Autotuning (AT) in the Parameter setting mode.

☞ For details of Autotuning (AT), refer to **8.4.2 Parameter setting item (P. 8-24)**.

Related parameter

Parameter setting mode:

- Autotuning (AT) (P. 8-24)

Engineering mode:

- AT cycles (P. 8-130)
- AT differential gap time (P. 8-131)

F05

Startup tuning (ST)

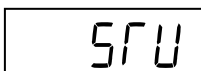
A rectangular box containing the text "STU" in a monospaced font.

Link to the Startup tuning (ST) in the Parameter setting mode.

☞ For details of Startup tuning (ST), refer to **8.4.2 Parameter setting item (P. 8-25)**.

Related parameter

Parameter setting mode:

- Startup tuning (ST) (P. 8-25)

Engineering mode:

- ST start condition (P. 8-132)

F05

F05 block selection (no display)



Hide parameter symbols of in the Parameter setting mode from the display.

Data range	Factory set value
0: Display 1: No display	0

When “No display” is selected, the parameters of Parameter setting mode are not displayed; however, F05 parameters are displayed.

For details of setting example, refer to **6.7 Display/No display Setting of Mode Screens (P. 6-32, P. 6-37)**.

Related parameter

Parameter setting mode:

- Autotuning (AT) (P. 8-24)
- Startup tuning (ST) (P. 8-25)

■ Description of function

Hide parameters of the Parameter setting mode from the display. Each parameter of Parameter setting mode link to the Engineering mode from F01 to F10. The parameters of the Parameter setting mode linked to the parameters of the Engineering mode is not displayed when “No display” is set to F05 block selection. Those parameters of the Parameter setting mode link to F05 block of the Engineering mode.

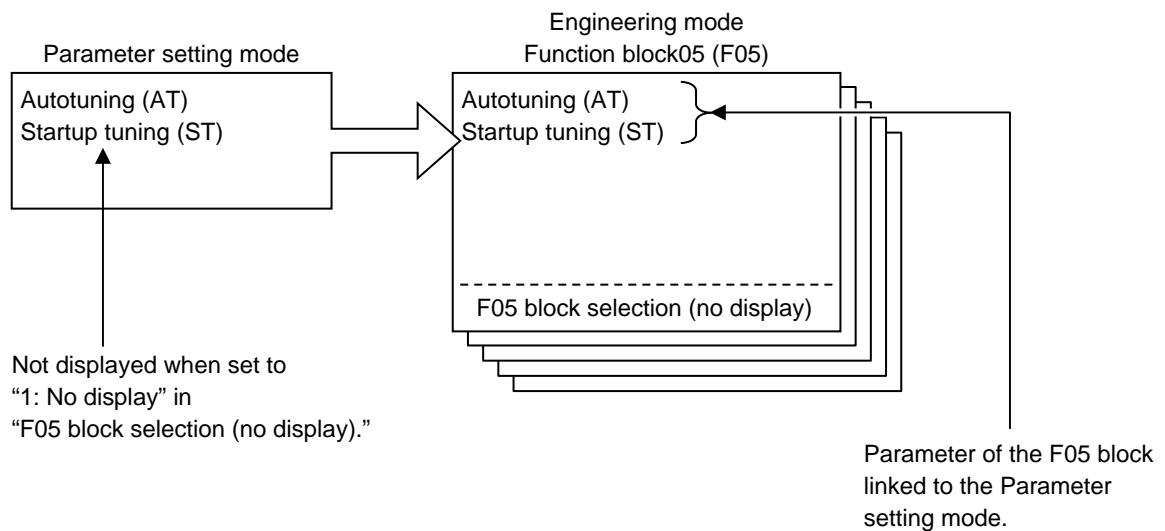

Function block 06 (F06)

A rectangular box containing the text "F06." in a monospaced font.

This is the first parameter symbol of Function block 06 (F06).

F06

Proportional band [heat-side]

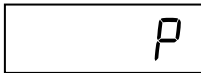
A rectangular box containing the text "P" in a monospaced font.

Link to the Proportional band [heat-side] in the Parameter setting mode.

☞ For details of Proportional band [heat-side], refer to **8.4.2 Parameter setting item (P. 8-26)**.

Related parameter

Parameter setting mode:

- Proportional band [heat-side] (P. 8-26)
- Overlap/Deadband (P. 8-29)

Engineering mode:

- Overlap/Deadband (P. 8-75)
- ON/OFF action differential gap (upper),
ON/OFF action differential gap (lower) (P. 8-126)

F06

Integral time

A rectangular box containing the text "I" in a monospaced font.

Link to the Integral time in the Parameter setting mode.

☞ For details of Integral time, refer to **8.4.2 Parameter setting item (P. 8-26)**.

Related parameter

Parameter setting mode:

- Integral time (P. 8-26)

F06

Derivative time



Link to the Derivative time in the Parameter setting mode.

 For details of Derivative time, refer to **8.4.2 Parameter setting item (P. 8-27)**.

Related parameter

Parameter setting mode:

- Derivative time (P. 8-27)

Engineering mode:

- Derivative action (P. 8-128)

F06

Anti-reset windup (ARW)



Link to the Anti-reset windup (ARW) in the Parameter setting mode.

 For details of Anti-reset windup (ARW), refer to **8.4.2 Parameter setting item (P. 8-27)**.

Related parameter

Parameter setting mode:

- Proportional band [heat-side] (P. 8-26)
- Anti-reset windup (ARW) (P. 8-27)

Engineering mode:

- Proportional band [heat-side] (P. 8-73)

F06

Proportional band [cool-side]

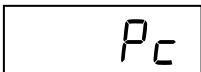

Link to the Proportional band [cool-side] in the Parameter setting mode.

 For details of Proportional band [cool-side], refer to **8.4.2 Parameter setting item (P. 8-28)**.

Related parameter

Parameter setting mode:

- Proportional band [cool-side] (P. 8-28)
- Overlap/Deadband (P. 8-29)

Engineering mode:

- Cool action (P. 8-125)

F06

Overlap/Deadband



Link to the Overlap/Deadband in the Parameter setting mode.

☞ For details of Overlap/Deadband, refer to **8.4.2 Parameter setting item (P. 8-29)**.

Related parameter

Parameter setting mode:

- Proportional band [heat-side] (P. 8-26)
- Proportional band [cool-side] (P. 8-28)
- Overlap/Deadband (P. 8-29)

Engineering mode:

- Proportional band [heat-side] (P. 8-73)
- Proportional band [cool-side] (P. 8-74)
- Cool action (P. 8-125)

F06

Fine tuning setting



Link to the Fine tuning setting in the Parameter setting mode.

☞ For details of Fine tuning setting, refer to **8.4.2 Parameter setting item (P. 8-30)**.

Related parameter

Parameter setting mode:

- Fine tuning setting (P. 8-30)

F06

F06 block selection (no display)



Hide parameter symbols of in the Parameter setting mode from the display.

Data range	Factory set value
0: Display 1: No display	0

When “No display” is selected, the parameters of Parameter setting mode are not displayed; however, F06 parameters are displayed.

For details of setting example, refer to **6.7 Display/No display Setting of Mode Screens (P. 6-32, P. 6-37)**.

Related parameter

Parameter setting mode:

- Proportional band [heat-side] (P. 8-26)
- Integral time (P. 8-26)
- Derivative time (P. 8-27)
- Anti-reset windup (ARW) (P. 8-27)
- Proportional band [cool-side] (P. 8-28)
- Overlap/Deadband (P. 8-29)
- Fine tuning setting (P. 8-30)

■ Description of function

Hide parameters of the Parameter setting mode from the display. Each parameter of Parameter setting mode link to the Engineering mode from F01 to F10. The parameters of the Parameter setting mode linked to the parameters of the Engineering mode is not displayed when “No display” is set to F06 block selection. Those parameters of the Parameter setting mode link to F06 block of the Engineering mode.

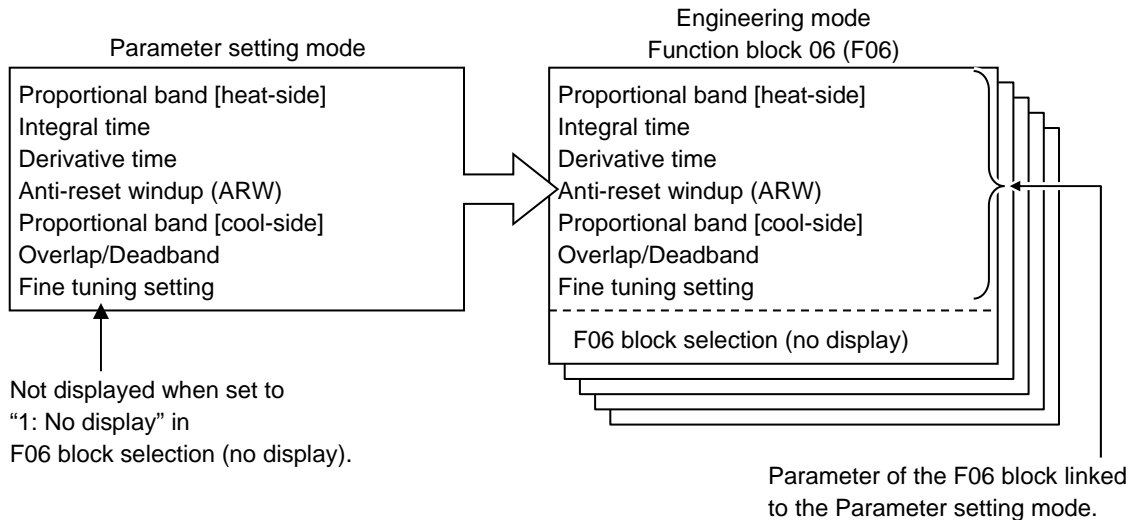

Function block 07 (F07)

A rectangular box containing the text "F07." in a monospaced font.

This is the first parameter symbol of Function block 07 (F07).

F07

Heater break alarm 1 (HBA1) set value

Heater break alarm 2 (HBA2) set value

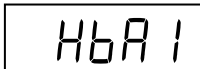
A rectangular box containing the text "HBA1" in a monospaced font.

Link to the Heater break alarm 1 (HBA1) set value and Heater break alarm 2 (HBA2) set value in the Parameter setting mode.

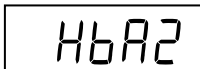
A rectangular box containing the text "HBA2" in a monospaced font.

 For details of Heater break alarm 1 (HBA1) set value and Heater break alarm 2 (HBA2) set value, refer to **8.4.2 Parameter setting item (P. 8-31)**.

Related parameter

Parameter setting mode:

- Heater break alarm 1 (HBA1) set value (P. 8-31)
- Heater break alarm 2 (HBA2) set value (P. 8-31)

Engineering mode:

- CT ratio (P. 8-122)
- Number of HBA delay times (P. 8-123)

F07

Control loop break alarm (LBA) time

LbA

Link to the Control loop break alarm (LBA) time in the Parameter setting mode.

☞ For details of Control loop break alarm (LBA) time, refer to **8.4.2 Parameter setting item (P. 8-32)**.

Related parameter

Parameter setting mode:

- Control loop break alarm (LBA) time (P. 8-32)
- LBA deadband (LBD) (P. 8-34)

Engineering mode:

- LBA deadband (LBD) (P. 8-78)
- Event 1 type to Event 4 type (P. 8-101)

F07

LBA deadband (LBD)

Lbd

Link to the LBA deadband (LBD) in the Parameter setting mode.

☞ For details of LBA deadband, refer to **8.4.2 Parameter setting item (P. 8-34)**.

Related parameter

Parameter setting mode:

- Control loop break alarm (LBA) time (P. 8-32)
- LBA deadband (LBD) (P. 8-34)

Engineering mode:

- Control loop break alarm (LBA) time (P. 8-78)
- Event 1 type to Event 4 type (P. 8-101)

F07

F07 block selection (no display)

SF07

Hide parameter symbols of in the Parameter setting mode from the display.

Data range	Factory set value
0: Display 1: No display	0

 When “No display” is selected, the parameters of Parameter setting mode are not displayed; however, F07 parameters are displayed.

 For details of setting example, refer to **6.7 Display/No display Setting of Mode Screens (P. 6-32, P. 6-37)**.

Related parameter

Parameter setting mode:

- Heater break alarm 1 (HBA1) set value (P. 8-31)
- Heater break alarm 2 (HBA2) set value (P. 8-31)
- Control loop break alarm (LBA) time (P. 8-32)
- LBA deadband (LBD) (P. 8-34)

■ Description of function

Hide parameters of the Parameter setting mode from the display. Each parameter of Parameter setting mode link to the Engineering mode from F01 to F10. The parameters of the Parameter setting mode linked to the parameters of the Engineering mode is not displayed when “No display” is set to F07 block selection. Those parameters of the Parameter setting mode link to F07 block of the Engineering mode.

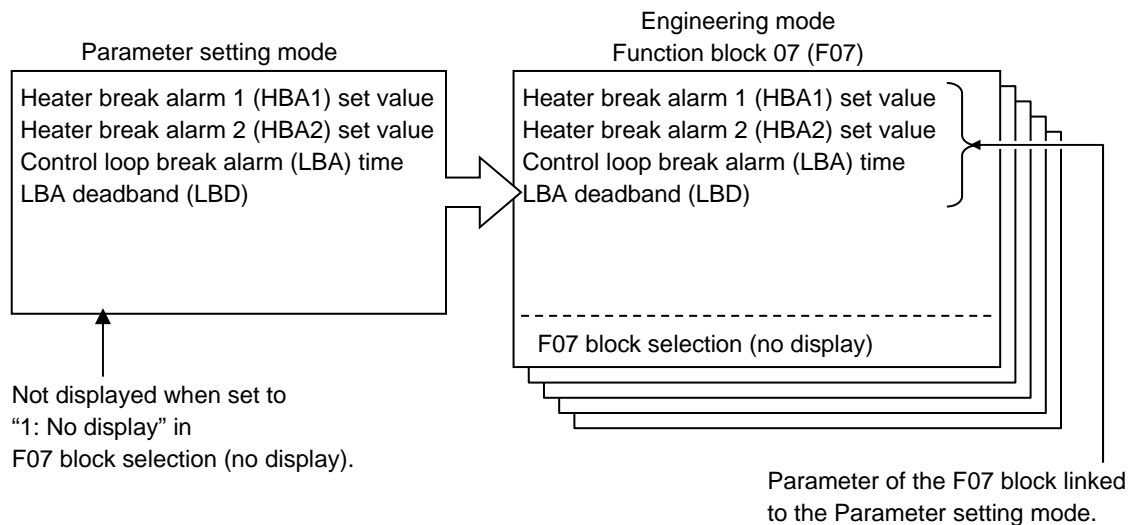

Function block 08 (F08)



This is the first parameter symbol of Function block 08 (F08).

F08

Proportional cycle time [heat-side]



Link to the Proportional cycle time [heat-side] in the Parameter setting mode.

 For details of Proportional cycle time [heat-side], refer to **8.4.2 Parameter setting item (P. 8-36)**.

Related parameter

Parameter setting mode:

- Proportional cycle time [heat-side] (P. 8-36)
- Minimum ON/OFF time of proportioning cycle [heat-side] (P. 8-37)

Engineering mode:

- Minimum ON/OFF time of proportioning cycle [heat-side] (P. 8-80)
- Time setting of proportional cycle time [heat-side] (P. 8-129)

F08

Minimum ON/OFF time of proportioning cycle [heat-side]

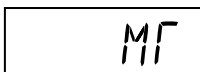

Link to the Minimum ON/OFF time of proportioning cycle [heat-side] in the Parameter setting mode.

 For details of Minimum ON/OFF time of proportioning cycle [heat-side], refer to **8.4.2 Parameter setting item (P. 8-37)**.

Related parameter

Parameter setting mode:

- Proportional cycle time [heat-side] (P. 8-36)
- Minimum ON/OFF time of proportioning cycle [heat-side] (P. 8-37)

Engineering mode:

- Proportional cycle time [heat-side] (P. 8-80)
- Time setting of proportional cycle time [heat-side] (P. 8-129)

F08

Output limiter high [Heat-side output limiter (high)] Output limiter low [Cool-side output limiter (high)]

oLH

Link to the Output limiter high and Output limiter low in the Parameter setting mode.

oLL

 For details of Output limiter high and Output limiter low, refer to **8.4.2 Parameter setting item (P. 8-38)**.

Related parameter

Parameter setting mode:

- Output limiter high [Heat-side output limiter (high)] (P. 8-38)
- Output limiter low [Cool-side output limiter (high)] (P. 8-38)

F08

Proportional cycle time [cool-side]

t

Link to the Proportional cycle time [cool-side] in the Parameter setting mode.

 For details of Proportional cycle time [cool-side], refer to **8.4.2 Parameter setting item (P. 8-39)**.

Related parameter

Parameter setting mode:

- Proportional cycle time [cool-side] (P. 8-39)
- Minimum ON/OFF time of proportioning cycle [cool-side] (P. 8-40)

Engineering mode:

- Minimum ON/OFF time of proportioning cycle [cool-side] (P. 8-82)
- Time setting of proportional cycle time [cool-side] (P. 8-129)

F08

Minimum ON/OFF time of proportioning cycle [cool-side]

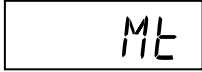

Link to the Minimum ON/OFF time of proportioning cycle [cool-side] in the Parameter setting mode.

■ For details of Minimum ON/OFF time of proportioning cycle [cool-side], refer to **8.4.2 Parameter setting item (P. 8-40)**.

Related parameter

Parameter setting mode:

- Proportional cycle time [cool-side] (P. 8-39)
- Minimum ON/OFF time of proportioning cycle [cool-side] (P. 8-40)

Engineering mode:

- Proportional cycle time [cool-side] (P. 8-81)
- Time setting of proportional cycle time [cool-side] (P. 8-129)

F08

F08 block selection (no display)

Hide parameter symbols of in the Parameter setting mode from the display.

Data range	Factory set value
0: Display 1: No display	0

When “No display” is selected, the parameters of Parameter setting mode are not displayed; however, F08 parameters are displayed.

For details of setting example, refer to **6.7 Display/No display Setting of Mode Screens (P. 6-32, P. 6-37)**.

Related parameter

Parameter setting mode:

- Proportional cycle time [heat-side] (P. 8-36)
- Minimum ON/OFF time of proportioning cycle [heat-side] (P. 8-37)
- Output limiter high [Heat-side output limiter (high)] (P. 8-38)
- Output limiter low [Cool-side output limiter (high)] (P. 8-38)
- Proportional cycle time [cool-side] (P. 8-39)
- Minimum ON/OFF time of proportioning cycle [cool-side] (P. 8-40)

■ Description of function

Hide parameters of the Parameter setting mode from the display. Each parameter of Parameter setting mode link to the Engineering mode from F01 to F10. The parameters of the Parameter setting mode linked to the parameters of the Engineering mode is not displayed when “No display” is set to F08 block selection. Those parameters of the Parameter setting mode link to F08 block of the Engineering mode.

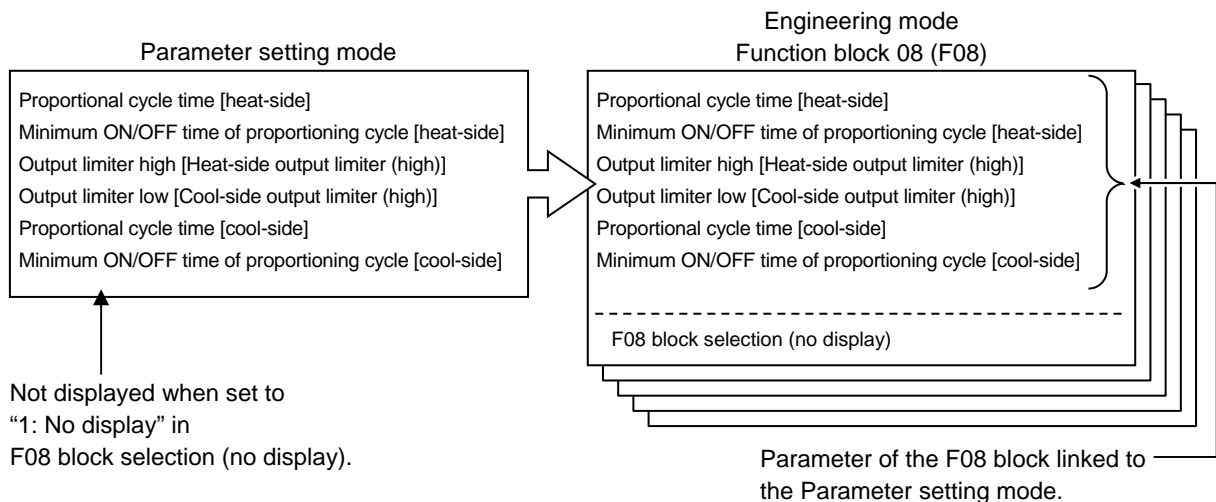

Function block 09 (F09)

A rectangular box containing the text "F09." in a monospaced font.

This is the first parameter symbol of Function block 09 (F09).

F09

PV bias

A rectangular box containing the text "Pb" in a monospaced font.

Link to the PV bias in the Parameter setting mode.

■ For details of PV bias, refer to **8.4.2 Parameter setting item (P. 8-41)**.

Related parameter

Parameter setting mode:

- PV bias (P. 8-41)

F09

PV digital filter

A rectangular box containing the text "dF" in a monospaced font.

Link to the PV digital filter in the Parameter setting mode.

■ For details of PV digital filter, refer to **8.4.2 Parameter setting item (P. 8-41)**.

Related parameter

Parameter setting mode:

- PV digital filter (P. 8-41)

F09

F09 block selection (no display)

SF09

Hide parameter symbols of in the Parameter setting mode from the display.

Data range	Factory set value
0: Display 1: No display	0

 When “No display” is selected, the parameters of Parameter setting mode are not displayed; however, F09 parameters are displayed.

 For details of setting example, refer to **6.7 Display/No display Setting of Mode Screens (P. 6-32, P. 6-37)**.

Related parameter

Parameter setting mode:

- PV bias (P. 8-41)
- PV digital filter (P. 8-41)

■ Description of function

Hide parameters of the Parameter setting mode from the display. Each parameter of Parameter setting mode link to the Engineering mode from F01 to F10. The parameters of the Parameter setting mode linked to the parameters of the Engineering mode is not displayed when “No display” is set to F09 block selection. Those parameters of the Parameter setting mode link to F09 block of the Engineering mode.

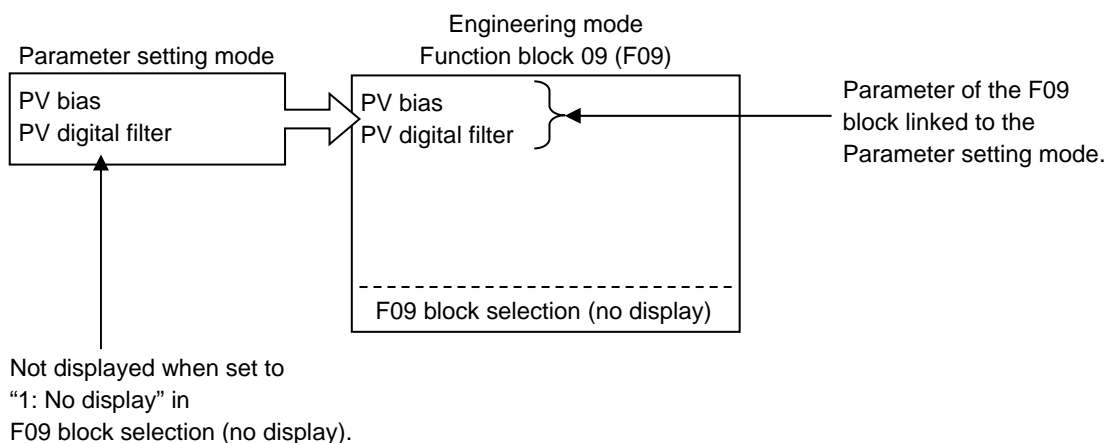

Function block 10 (F10)

A rectangular box containing the text "F 10." in a monospaced font.

This is the first parameter symbol of Function block 10 (F10).

F10

Manual manipulated output value (MV)

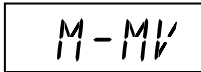
A rectangular box containing the text "M-MV" in a monospaced font.

Link to the Manual manipulated output value (MV) in the Parameter setting mode and Measured value (PV)/Manipulated output value (MV) in the SV setting mode.

☞ For details of Manual manipulated output value (MV), refer to **8.4.2 Parameter setting item (P. 8-42)**.

Related parameter

Parameter setting mode:

- Manual manipulated output value (MV) (P. 8-42)

F10

F10 block selection (no display)

SF 10

Hide parameter symbols of in the Parameter setting mode from the display.

Data range	Factory set value
0: Display 1: No display	1

 When “No display” is selected, the parameters of Parameter setting mode are not displayed; however, F10 parameters are displayed.

 For details of setting example, refer to **6.7 Display/No display Setting of Mode Screens (P. 6-32, P. 6-37)**

Related parameter

Parameter setting mode:

- Manual manipulated output value (MV) (P. 8-42)

■ Description of function

Hide parameters of the Parameter setting mode from the display. Each parameter of Parameter setting mode link to the Engineering mode from F01 to F10. The parameters of the Parameter setting mode linked to the parameters of the Engineering mode is not displayed when “No display” is set to F10 block selection. Those parameters of the Parameter setting mode link to F10 block of the Engineering mode.

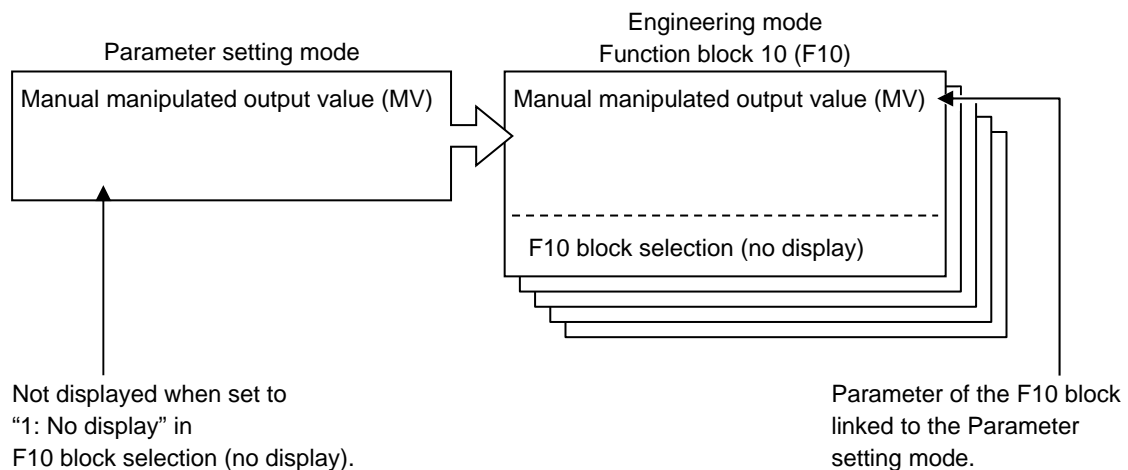

 To display F21 and after, setting ModE (Mode selection [no display]) in F00 to 128 is required.
(Refer to P. 8-52)

Function block 21 (F21)

 F21.

This is the first parameter symbol of Function block 21 (F21).

F21

Input type

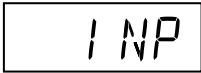
 INP

Data range: 0 to 38 (refer to the following table)

 The Input type can be changed. Inputs are selectable within each group (TC/RTD input group, Voltage/Current input group).

	Data range	Factory set value
0:	TC input K	Based on model code
1:	TC input K	
2:	TC input K	
3:	TC input J	
4:	TC input J	
5:	TC input T	
6:	TC input T	
8:	TC input S	
9:	TC input R	
10:	TC input E	
11:	TC input B	
12:	TC input N	
13:	TC input PLII	
14:	TC input W5Re/W26Re	
15:	RTD input Pt100	
16:	RTD input JPt100	
17:	TC input K	
18:	TC input K	
19:	TC input J	
20:	TC input J	
21:	TC input T	
22:	TC input T	
23:	TC input T	
24:	TC input S	
25:	TC input R	
26:	TC input E	
27:	TC input B	
28:	TC input N	
29:	TC input PLII	
30:	TC input W5Re/W26Re	
31:	RTD input Pt100	

 **Do not set to any number which is not described in the input range table above. This may cause malfunction.**

Continued on the next page.

Continued from the previous page.

Data range		Factory set value
33: Voltage input 0 to 1 V DC	Programmable range –1999 to +9999 (The decimal point position is selectable)	0.0 to 100.0
34: Voltage input 0 to 5 V DC		
35: Voltage input 0 to 10 V DC		
36: Voltage input 1 to 5 V DC		
37: Current input 0 to 20 mA DC		
38: Current input 4 to 20 mA DC		



Do not set to any number which is not described in the input range table above. This may cause malfunctioning.



If the Input type is changed, the Decimal point position, the Input scale high and the Input scale low are initialized. It is required to reset the settings.

For the parameters which will be initialized if the Input type is changed, refer to ■ **When input type (INP) is changed (P. 8-52)**.



Connect a 250 Ω shunt resistor to the measuring input terminals number 11 and 12 for current input (0 to 20 mA DC and 4 to 20 mA DC)

Related parameters

Engineering mode:

- Decimal point position (P. 8-90)
- Input scale high (P. 8-91)
- Input scale low (P. 8-91)

F21

Decimal point position

Use to select the Decimal point position of the input range.

Data range	Factory set value
0: No decimal place 1: One decimal place 2: Two decimal places 3: Three decimal places TC/RTD input: 0 or 1 Voltage (V)/Current (I) inputs: 0 to 3	Based on model code

Related parameters

Engineering mode:

- Input type (P. 8-88)
- Input scale high (P. 8-91)
- Input scale low (P. 8-91)

F21.

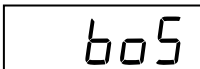
Burnout direction

Use to select Burnout direction in input break. When input break is detected by the controller, the measured value will go either upscale or downscale according to the Burnout direction setting.

Data range	Factory set value
0: Upscale 1: Downscale	0



The Burnout direction setting is effective only for thermocouple input.



For the following types of input, the action when an input break occurs is fixed, regardless of the Burnout direction setting.

RTD input: Upscale

Voltage input: Downscale or Display of about 0 V

Current input: Downscale or Display of about 0 mA

F21

Input scale high**Input scale low**

PUSH

PUSL

Use to set the high limit and low limit of the input scale range.

Data range	Factory set value
Input scale high TC/RTD inputs: Input scale low to Maximum value of the selected input range	Maximum value of the selected input range
Voltage (V)/Current (I) inputs: -1999 to +9999 (Varies with the setting of the Decimal point position) *	100.0
Input scale low TC/RTD inputs: Minimum value of the selected input range to Input scale high	Minimum value of the selected input range
Voltage (V)/Current (I) inputs: -1999 to +9999 (Varies with the setting of the Decimal point position) *	0.0

* Input scale low < Input scale high

Related parameters

Engineering mode:

- Input type (P. 8-88)
- Decimal point position (P. 8-90)
- Setting limiter high, Setting limiter low (P. 8-93)

■ **Description of function**

The input range can be changed for temperature input (TC/RTD).

Example [temperature input]:

When the range of -200 to $+1372$ °C for thermocouple type K is changed to 0 to 400 °C

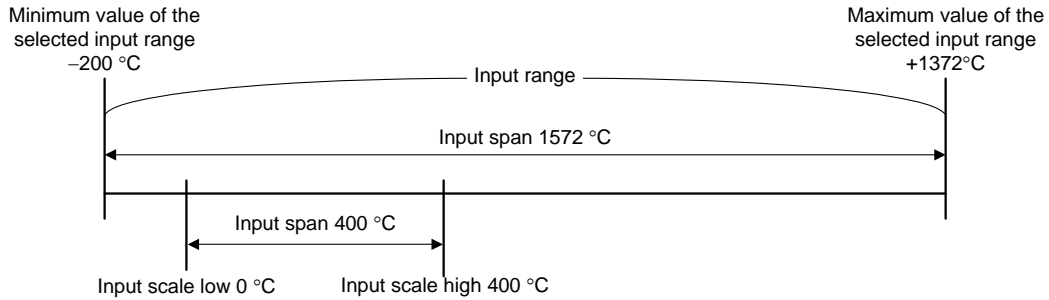

When the scale for temperature input is changed, it is recommended that the change should be within the input range. If any value exceeds the recommended input range, input resolution may vary.

For voltage (V)/current (I) inputs, display scaling can be made in the range of -1999 to $+9999$.

Example [Voltage (V)/Current (I) inputs]:

When the input scale is changed to “ 0.0 to 50.0 ” from “ 0.0 to 100.0 ” at a voltage input of 1 to 5 V DC

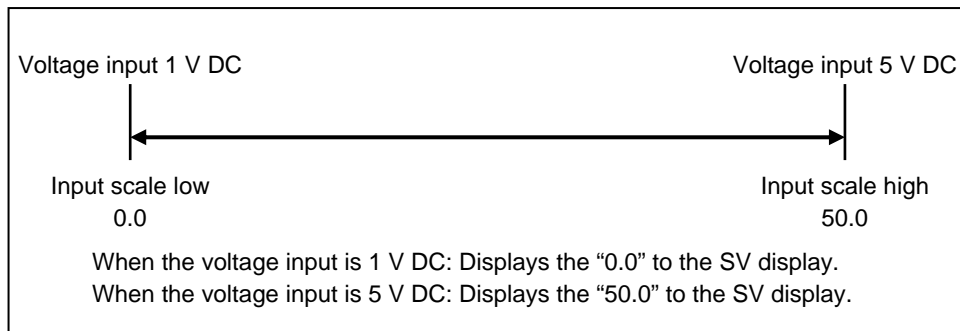
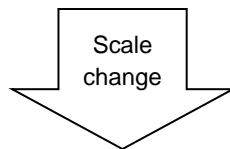
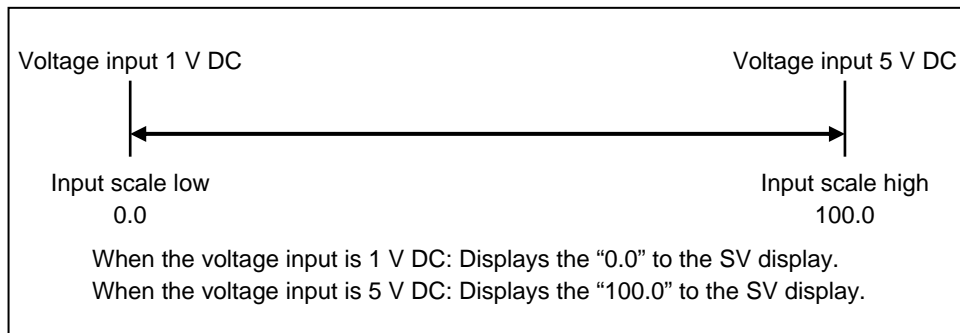

F21

Setting limiter high

Setting limiter low

SLH

Setting limiter high: Use to set a high limit of the set value.

Setting limiter low: Use to set a low limit of the set value.

SLL

Data range	Factory set value
Setting limiter high Setting limiter low to Input scale high	Input scale high
Setting limiter low: Input scale low to Setting limiter high	Input scale low

Related parameters

Engineering mode:

- Input type (P. 8-88)
- Decimal point position (P. 8-90)
- Input scale high, Input scale low (P. 8-91)

■ Description of function

Setting limiter is to set the range of the Set value (SV).

[Example]: Input scale range is from 0 to 400 °C, the Setting limiter high is 200 °C, and the Setting limiter low is 20 °C.

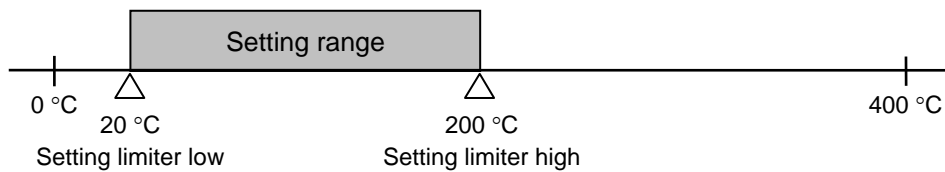

F21

PV flashing display at input error

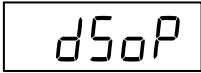

It can also be set so that the PV display does not flash “1: Non-flashing display.” The Measured value (PV) of this instrument flashes in the range of an “input span of 5 %” if exceeding the input range.

Data range	Factory set value
0: Flashing display	0
1: Non-flashing display	

■ **Example: When set to non-flashing display in the range of 0 to 800 °C**

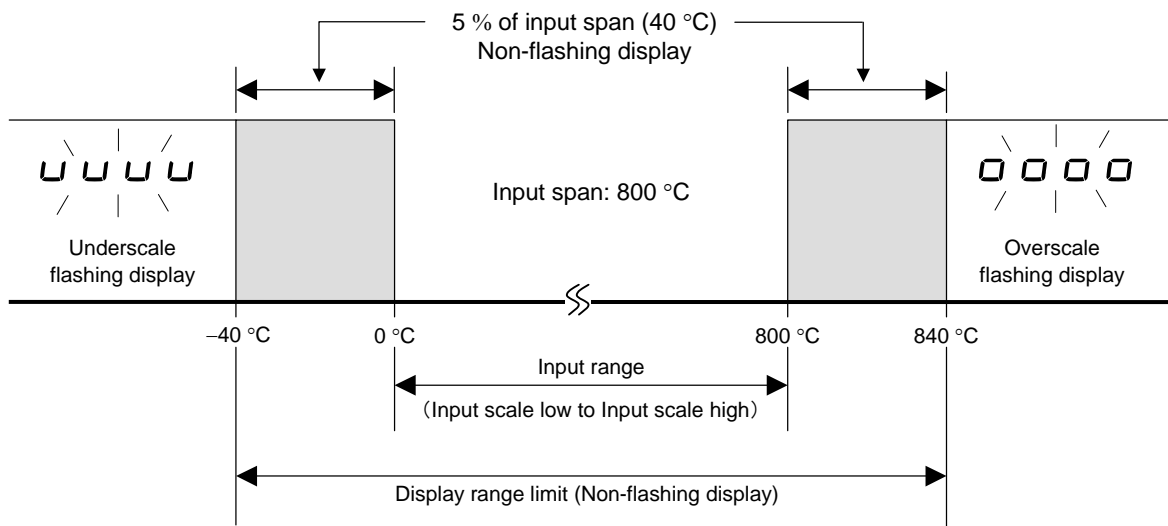

Function block 23 (F23)

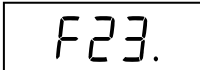

This is the first parameter symbol of Function block 23 (F23).

F23

DI assignment

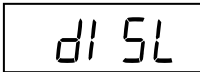

Use to assign the function (SV selection function, interlock release, RUN/STOP transfer, or Auto/Manual transfer) for the Digital inputs (DI1, DI2).

Data range	Factory set value
0 to 7 (Refer to the following table Digital input (DI) assignment .)	Based on model code

Digital input (DI) assignment

Set value	DI1	DI2
	Terminal No.17-18	Terminal No.16-18
0	Unused (No DI assignment)	
1	SV selection function (SV1 to SV4) ¹	
2	SV selection function (SV1 to SV2) ²	RUN/STOP transfer ³
3	SV selection function (SV1 to SV2) ²	Auto/Manual transfer ⁴
4	SV selection function (SV1 to SV2) ²	Interlock release ⁵
5	RUN/STOP transfer ³	Auto/Manual transfer ⁴
6	RUN/STOP transfer ³	Interlock release ⁵
7	Auto/Manual transfer ⁴	Interlock release ⁵

¹ SV selection function (SV1 to SV4)

	SV1	SV2	SV3	SV4
DI1	Contact open	Contact closed	Contact open	Contact closed
DI2	Contact open	Contact open	Contact closed	Contact closed

² SV selection function (SV1 to SV2): Contact open state: SV1 Contact closed state: SV2

³ RUN/STOP transfer: Contact open state: STOP Contact closed state: RUN

⁴ Auto/Manual transfer: Contact open state: Manual Contact closed state: Auto

⁵ Interlock release: Interlock is released at the time of contact status change (from open to close).

 For digital input transfer, refer to following pages.

- SV selection function: Refer to **■ Set the control set value (P. 5-6)**.
- RUN/STOP transfer: Refer to **6.1 RUN/STOP Transfer (P. 6-6)**.
- Auto/Manual transfer: Refer to **6.5 Auto/Manual Transfer (P. 6-22)**.
- Interlock release: Refer to **6.8 Interlock Release (P. 6-41)**.

Function block 30 (F30)

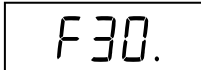

This is the first parameter symbol of Function block 30 (F30).

F30

Output action at STOP mode



Use to select action of Event output or Transmission output when the controller is set to STOP (control STOP).

Data range	Factory set value
0: Both event output and transmission output (AO) are off.	0
1: Event output remains unchanged, and transmission output (AO) is off.	
2: Event output is off, and transmission output (AO) remains unchanged.	
3: Both event output and transmission output (AO) remain unchanged.	



When the Digital output (DO1 to DO4) and Transmission output are not provided, this parameter is invalid.

Related parameters

Engineering mode:

- Event 1 type (P. 8-101)
- Event 2 type (P. 8-101)
- Event 3 type (P. 8-101)
- Event 4 type (P. 8-101)

F30

STOP display selection



STOP message for control STOP mode can be displayed either on the upper display or the lower display. SPCH is to select the display to show the STOP message.

Data range	Factory set value
0: STOP on PV display + STOP lamp (green) lights	1
1: STOP on SV display + STOP lamp (green) lights	
2: STOP lamp (green) lights	

■ Description of function

Parameter display in the STOP mode (control STOP)

- When the STOP display selection is set to “0: STOP on PV display + STOP lamp (green) lights”

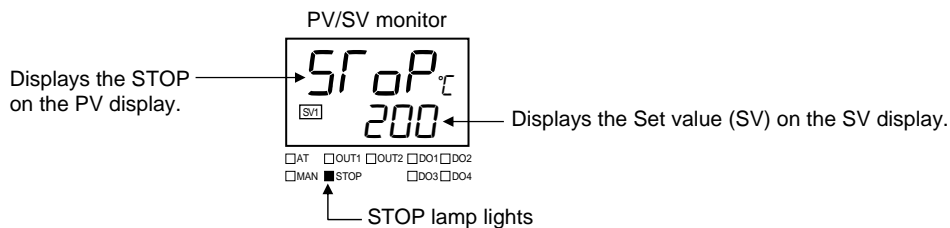

- When the STOP display selection is set to “1: STOP on SV display + STOP lamp (green) lights”

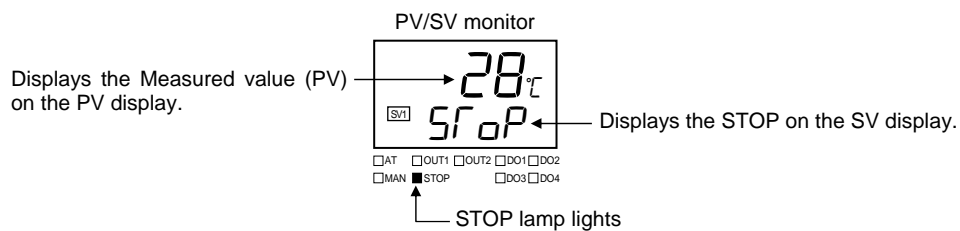

- When the STOP display selection is set to “2: STOP lamp (green) lights”

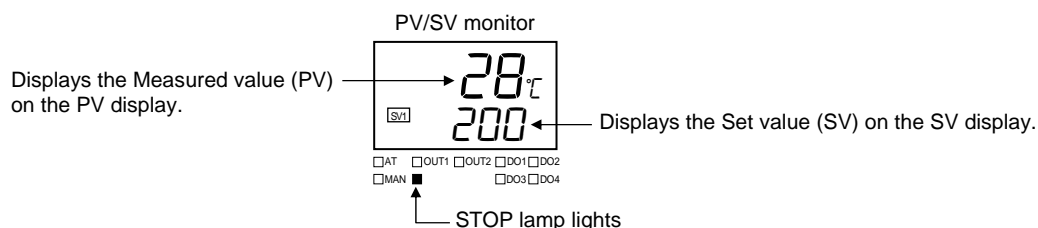

Function block 33 (F33)

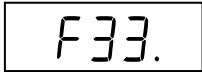

This is the first parameter symbol of Function block 33 (F33).
Transmission output (optional) function must be specified.

F33

Transmission output type



Use to select the Transmission output type.

Data range	Factory set value
0: Manipulated output value (MV1)	1
1: Measured value (PV)	
2: Set value (SV)	

Related parameters

Engineering mode:

- Output status at STOP mode (P. 8-96)
- Transmission output scale high (P. 8-99)
- Transmission output scale low (P. 8-99)
- AO full scale adjustment value (P. 8-100)
- AO zero point adjustment value (P. 8-100)

■ Description of function

The Transmission output function (optional) is outputting the state of Measured value (PV), Set value (SV) or Manipulated output value (MV1) as a voltage or current signal. It is possible to record the state of Measured value (PV) or Set value (SV) when connected to a recorder.

Output types of transmission output:

Voltage output	0 to 5 V DC, 0 to 10 V DC, 1 to 5 V DC
Current output	0 to 20 mA DC, 4 to 20 mA DC



For the setting example of Transmission output, refer to **7.3 Transmission Output Function (P. 7-12)**.

F33

Transmission output scale high

Transmission output scale low

AHS

ALS

Use to set a scale high limit value or low limit value of the Transmission output.

Data range	Factory set value
Transmission output scale high When MV1 is selected: Transmission output scale low to +105.0 % When PV or SV is selected: Transmission output scale low to Input scale high	High-limit value of input span
Transmission output scale low When MV1 is selected: -5.0 % to Transmission output scale high When PV or SV is selected: Input scale low to Transmission output scale high	Low-limit value of input span

 The Decimal point position is the same as Decimal point position (P_{LdP}) of the input.

Related parameters

Engineering mode:

- Output action at STOP mode (P. 8-96)
- Transmission output type (P. 8-98)
- AO full scale adjustment value, AO zero point adjustment value (P. 8-100)

■ Description of function

This is a scaling of the output range of the transmission content selected by the Transmission output type (Ao).

Example: If scaling is made under the following conditions:

Output signal type: Current output 4 to 20 mA DC

Transmission output scale high (AHS): +1372 °C

Transmission output type (Ao): Measured value (PV)

Transmission output scale low (ALS): -200 °C

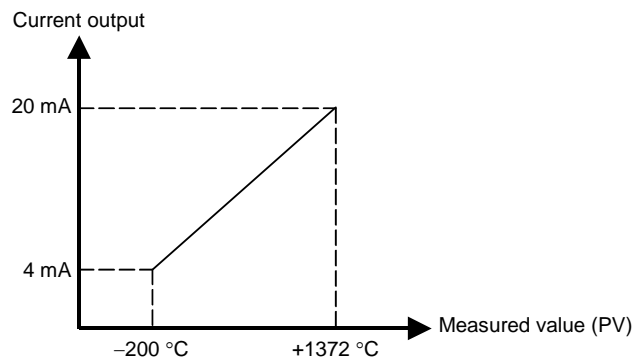

For the setting example of Transmission output, refer to **7.3 Transmission Output Function (P. 7-12)**.

F33

AO full scale adjustment value

AO zero point adjustment value

A0FS

To correct error between instruments, set AO full scale/Zero point adjustment value.

A0ZR

Data range	Factory set value
-10.0 to +10.0 %	Adjustment value



Do not change the factory set adjustment value for the AO full scale adjustment value and or the AO zero adjustment value as the accuracy will be changed.

(Transmission output accuracy: ± 0.3 % of span)

Related parameters

Engineering mode:

- Output action at STOP mode (P. 8-96)
- Transmission output type (P. 8-98)
- Transmission output scale high, Transmission output scale low (P. 8-99)

■ Description of function (output calibration)

AO full scale/Zero point adjustment value will correct the error between the output signal from the instrument and the reading of other instrument.



For the setting example of Zero and Full scale points, refer to **■ Output calibration (P. 7-13)**.

Function block 41 (F41)**Function block 42 (F42)****Function block 43 (F43)****Function block 44 (F44)**

F41.

This is the first parameter symbol of Function block 41 (F41).

F42.

This is the first parameter symbol of Function block 42 (F42).

F43.

This is the first parameter symbol of Function block 43 (F43).

F44.

This is the first parameter symbol of Function block 44 (F44).

F41

Event 1 type

F42

Event 2 type

F43

Event 3 type

F44

Event 4 type

E51

Use to select a action type of the Event 1.

E52

Use to select a action type of the Event 2.

E53

Use to select a action type of the Event 3.

E54

Use to select a action type of the Event 4.

Data range	Factory set value
0 to 23 Refer to Event type (P. 8-102) .	0 If the Event type is specified by the initial setting code when ordering, that Event type will be the factory set value.

Event type

Set value	Event type	Initial setting code
0	None	N
1	Deviation high (Using SV monitor value) ¹	A (With hold action: E With re-hold action: Q)
2	Deviation low (Using SV monitor value) ¹	B (With hold action: F With re-hold action: R)
3	Deviation high/low (Using SV monitor value) ¹	C (With hold action: G With re-hold action: T)
4	Band (Using SV monitor value)	D
5	Deviation high/low (SV Using SV monitor value) [High/Low individual setting] ¹	X (With hold action: Y With re-hold action: Z)
6	Band (Using SV monitor value) [High/Low individual setting]	U
7	SV high (Using SV monitor value)	V
8	SV low (Using SV monitor value)	W
9	Process high ²	H (With hold action: K)
10	Process low ²	J (With hold action: L)
11	Control loop break alarm (LBA) ³	2
12	Monitor during RUN	4
13	FAIL	3
14	Deviation high (Using local SV) ¹	—
15	Deviation low (Using local SV) ¹	—
16	Deviation high/low (Using local SV) ¹	—
17	Band (Using local SV)	—
18	Deviation high/low (Using local SV) [High/Low individual setting] ¹	—
19	Band (Using local SV) [High/Low individual setting]	—
20	SV high (Using local SV)	—
21	SV low (Using local SV)	—
22	Heater break alarm (HBA)	1
23	Output of the communication monitoring result	5

¹ Event hold and re-hold action is available.

² Event hold action is available.

³ For Heat/Cool control type, the LBA function is not available.

Related parameters**Parameter setting mode**

- Event 1 set value (EV1) to Event 4 set value (EV4) (P. 8-20)
- Event 1 set value (EV1) [high] to Event 4 set value (EV4) [high] (P. 8-20)
- Event 1 set value (EV1') [low] to Event 4 set value (EV4') [low] (P. 8-22)

Engineering mode:

- Event 1 hold action to Event 4 hold action (P. 8-110)
- Event 1 differential gap to Event 4 differential gap (P. 8-113)
- Event 1 output action at input burnout to Event 4 output action at input burnout (P. 8-115)
- Energized/De-energized of Event 1 output to Energized/De-energized of Event 4 output (P. 8-116)
- Event 1 timer to Event 4 timer (P. 8-118)
- Event 1 interlock to Event 4 interlock (P. 8-120)

■ Description of function

● FAIL

Operation stops if FAIL occurs

(FAIL output [fixed at de-energized]: contact open when error occurs)

FAIL output is ON (contact open) when power is supplied to the instrument only through loader communication.

● Monitor during RUN

Event ON at RUN (Event OFF at STOP)

Useful for operations such as turning on an indicator lamp or a rotary beacon light.

● Output of the communication monitoring result

Event signal is turned on when communication is not made for 10 seconds.

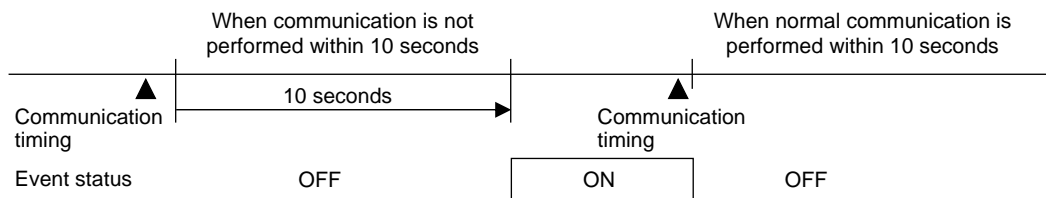

Settings on Event set value (Parameter setting mode), Event hold action, and Event differential gap are not available when the Event output is set for FAIL, Monitor during RUN or output of the Communication monitoring result.

Continued on the next page.

● **Deviation action (High, low, High/low, Band)**

When the deviation (PV – SV) reaches the Event set value, event ON occurs.

SV monitor value type and local SV value type are available for Deviation action.

<p>SV monitor value type</p>	<p>The Event set value is set for the SV monitor value. Setting change rate limiter adjusts the Event set value to follow the same change rate of SV monitor value.</p> <p>SV monitor value: SV monitor value is displayed in the Measured value (PV)/Set value (SV) monitor screen (Monitor display mode). When Setting change rate limiter is set, the Set value (SV) in the changing process is displayed.</p>
<p>Local SV type</p>	<p>The Event set value is set for the Set value (SV) [Local SV].</p> <p>Local SV: Local SV is displayed in the Measured value (PV)/Set value (SV) screen (SV setting mode).</p>

SV monitor value type

[When setting change rate limiter is not set.]

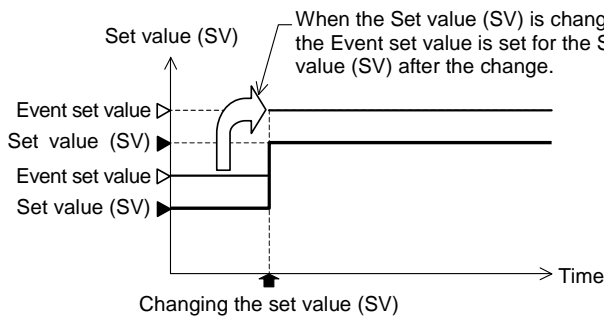

[When setting change rate limiter is set.]

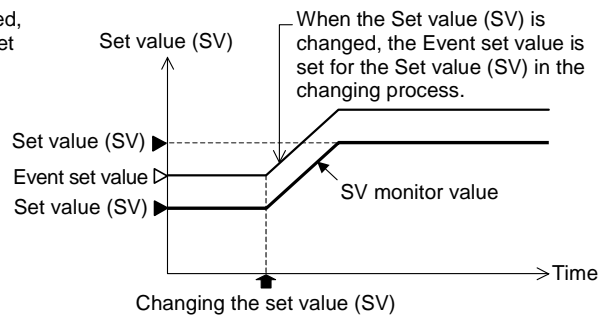

Local SV type

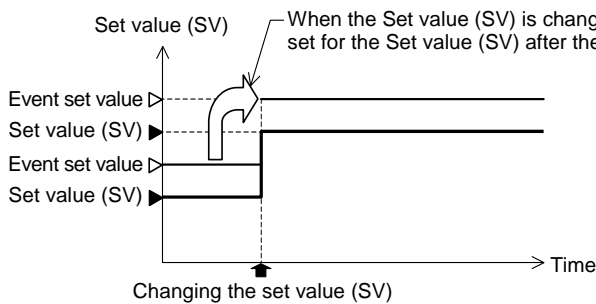

Local SV type has only one type of action on change with or without the Setting change rate limiter.



For the Setting change rate limiter, refer to the **Setting change rate limiter [up/down]** (P. 8-66).

Some examples of Deviation high are described in the following:

Deviation high: When the deviation (PV – SV) is more than the Event set value, the event ON occurs.

SV monitor value type
(Example: When setting change rate limiter is set.)

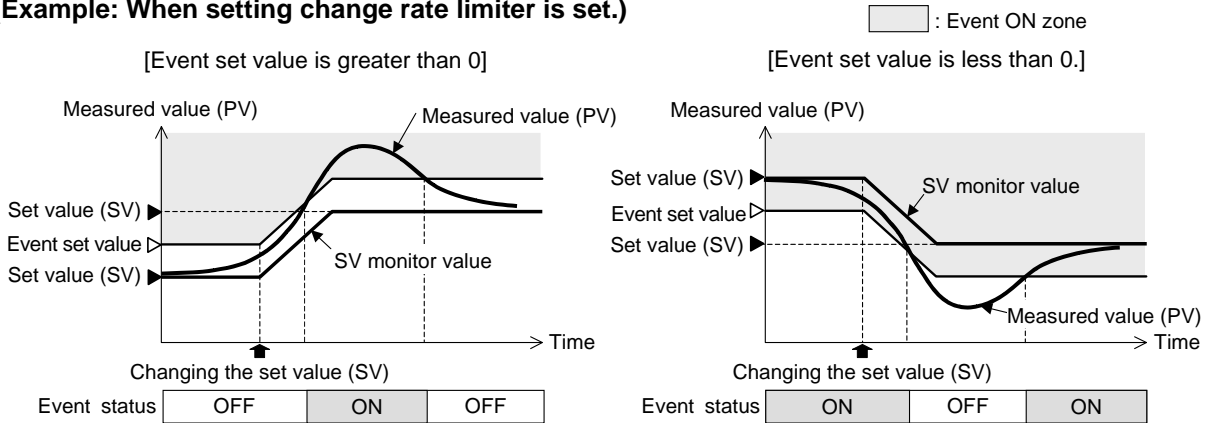

Local SV type

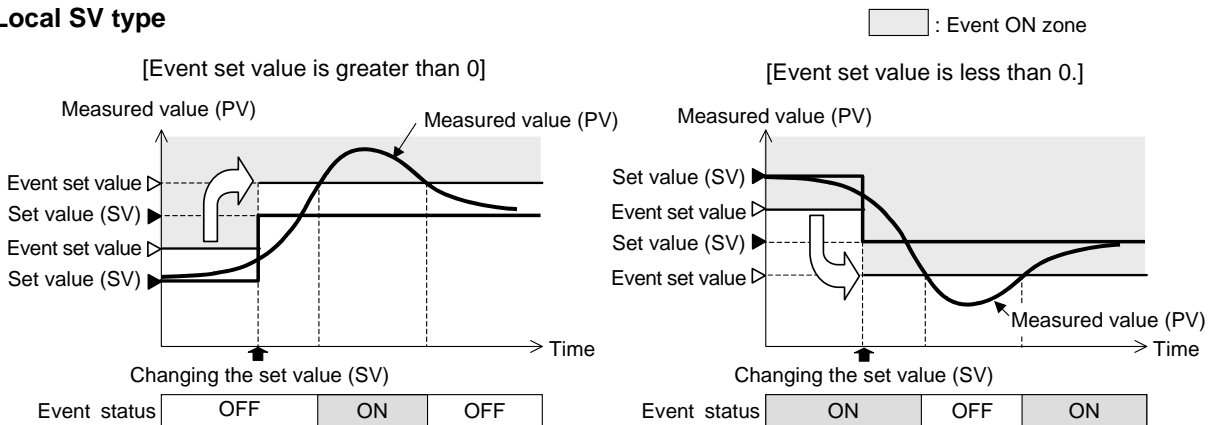

Event turns ON or OFF in accordance with the Differential gap setting.
 Refer to **Event 1 to Event 4 Differential gap (P. 8-113)**.

Diagrams of the Deviation action type are shown in the following:

ON: Event action turned on

OFF: Event action turned off (▲ : Set value (SV) Δ: Event set value ☆: Event differential gap)

Deviation high

When the deviation (PV – SV) is more than the Event set value, the event ON occurs.

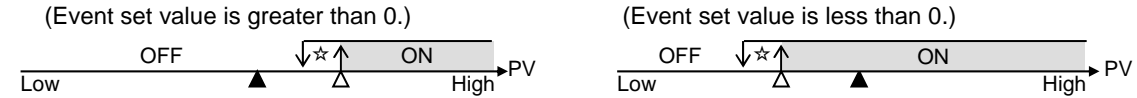

Deviation low

When the deviation (PV – SV) is less than the Event set value, the event ON occurs.

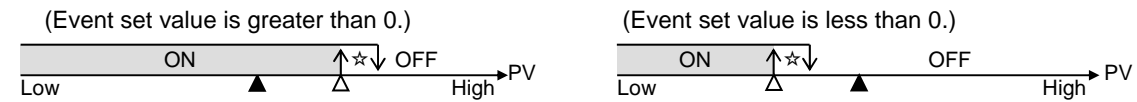

Deviation high/low

Two types of Deviation high/low action are available.

Without high/low individual setting:

When the absolute deviation | PV – SV | is more/less than the Event set values, the event ON occurs.

With high/low individual setting:

High action: When the deviation (PV – SV) is more than the Event set value [high], the event ON occurs.

Low action: When the deviation (PV – SV) is less than the Event set value [low], the event ON occurs.

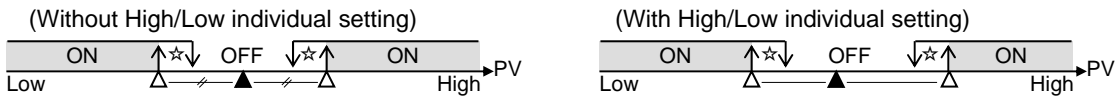

Band

Two types of Band action are available.

Without high/low individual setting:

When the absolute deviation | PV – SV | is within the Event set values, the event ON occurs.

With high/low individual setting:

High action: When the deviation (PV – SV) is less than the Event set value [high], the event ON occurs.

Low action: When the deviation (PV – SV) is more than the Event set value [low], the event ON occurs.

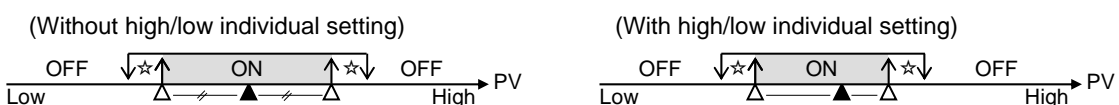

● Set value action (High, Low)

When the Set value (SV) reaches the Event set value, event ON occurs.

SV monitor value type and local SV value type are available for Set value action.

SV monitor value type	<p>Event turns on when SV monitor value reaches Event set value.</p> <p>Setting change rate limiter turns on the event when the Set value (SV) in the changing process reaches Event set value.</p> <p>SV monitor value: SV monitor value is displayed in the Measured value (PV)/Set value (SV) monitor screen (Monitor display mode). When Setting change rate limiter is set, the Set value (SV) in the changing process is displayed.</p>
Local SV type	<p>Event turns on when Set value (SV) [Local SV] reaches Event set value.</p> <p>Local SV: Local SV is displayed in the Measured value (PV)/Set value (SV) screen (SV setting mode).</p>

Some examples of SV high are described in the following:

SV high: When the Set value (SV) is more than the Event set value, the event ON occurs.

SV monitor value type

[When setting change rate limiter is not set.]

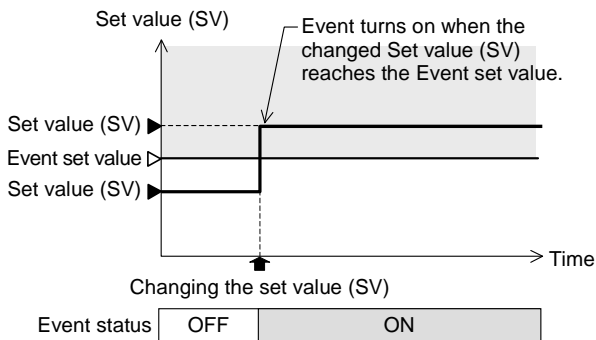

[When setting change rate limiter is set.]

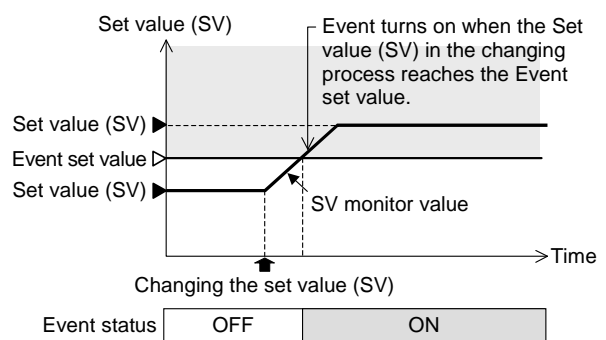

Local SV type

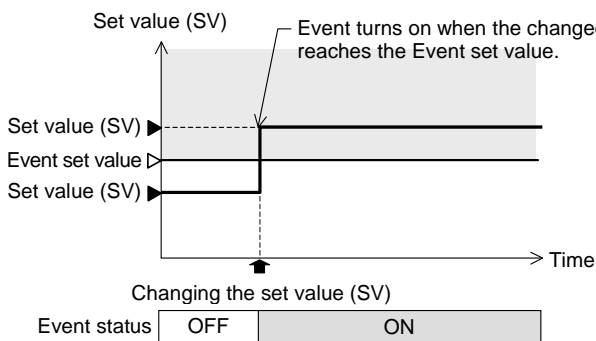

Local SV type has only one type of action on a change with or without the Setting change rate limiter.

☞ For the Setting change rate limiter, refer to the **Setting change rate limiter [up/down]** (P. 8-66).

Diagrams of the Set value action type are shown in the following:

ON: Event action turned on

OFF: Event action turned off (▲: Set value (SV) Δ: Event set value ☆: Event differential gap)

SV high

When the Set value (SV) is more than the Event set value, the event ON occurs.

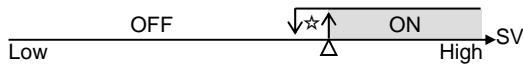

SV low

When the Set value (SV) is less than the Event set value, the event ON occurs.

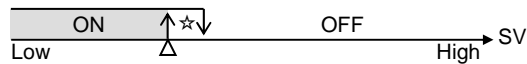

● Input value action (High, Low)

When the Measured value (PV) reaches the Event set value, event ON occurs.

Diagrams of the input value action type are shown in the following.

ON: Event action turned on

OFF: Event action turned off (▲: Set value (SV) Δ: Event set value ☆: Event differential gap)

Process high

When the Measured value (PV) is more than the Event set value, the event ON occurs.

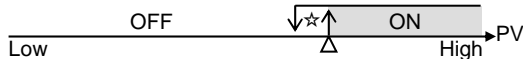

Process low

When the Measured value (PV) is less than the Event set value, the event ON occurs.

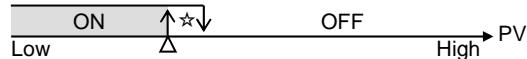

● Heater Break Alarm (HBA)

Heater break alarm (HBA) can only be used with time-proportional control output (relay, voltage pulse, or triac output).

The HBA function monitors the current flowing through the load by a dedicated current transformer (CT), compares the measured value with the HBA set values, and detects a fault in the heating circuit.

Low or No current flow (Heater break, malfunction of the control device, etc.):

When the control output is ON and the CT input value is equal to or less than the heater break determination point for the preset number of consecutive sampling cycles, an alarm is activated. However, Heater break alarm is not activated when control output ON time is 0.5 second or less.

Over current or short-circuit:

When the control output is OFF and the CT input value is equal to or greater than the heater break determination point for the preset number of consecutive sampling cycles, an alarm is activated. However, Heater break alarm is not activated when control output OFF time is 0.5 second or less.



Set the set value to approximately 85 % of the maximum reading of the CT input.



Set the set value to a slightly smaller value to prevent a false alarm if the power supply becomes unstable.



When more than one heater is connected in parallel, the HBA set value may need to be increased to detect a single heater failure.

● Control loop break alarm (LBA)

The Control loop break alarm (LBA) function is used to detect a load (heater) break or a failure in the external actuator (power controller, magnet relay, etc.), or a failure in the control loop caused by an input (sensor) break.

The LBA function is activated when control output reaches 0 % (low limit with output limit function) or 100 % (high limit with output limit function). LBA monitors variation of the Measured value (PV) for the length of LBA time. When the LBA time has elapsed and the PV is still within the alarm determination range, the LBA will be ON.

[Alarm action]

LBA determination range: Thermocouple/RTD input: 2 °C [°F] (fixed)

Voltage/Current input: 0.2 % of span (fixed)

● Heat control

	When the output reaches 0 % (low limit with output limit function)	When the output exceeds 100 % (high limit with output limit function)
For reverse action	When the LBA time has passed and the PV has not fallen below the alarm determination range, the alarm will be turned on.	When the LBA time has passed and the PV has not risen beyond the alarm determination range, the alarm will be turned on.
For direct action	When the LBA time has passed and the PV has not risen beyond the alarm determination range, the alarm will be turned on.	When the LBA time has passed and the PV has not risen beyond the alarm determination range, the alarm will be turned on.



If the Autotuning function is used, the LBA time is automatically set twice as large as the Integral time. The LBA setting time will not be changed even if the Integral time is changed.



Normally the LBA time of Parameter setting mode should be set to approximately twice the Integral time.



LBA function is not operative when:

- When AT function is activated.
- When the controller is in STOP mode.
- LBA time is set to “0.”
- LBA function is not assigned to Event 1 (ES1) to Event 4 (ES4).



If the LBA time is too short or does not match the controlled object requirements, LBA may turn ON or OFF at inappropriate time or remain OFF. Change the LBA time based on the malfunction.



If the LBA function detects an error occurring in the control loop, but cannot specify the location, the control loop should be checked. The LBA function does not detect the location which causes alarm status. If LBA alarm is ON, check each device or wiring in the control loop.



While the LBA is ON (under alarm status), the following conditions will cancel the alarm status and LBA will be OFF:

- The Measured value (PV) rises beyond (or falls below) the LBA determination range within the LBA time.
- The Measured value (PV) enters within the LBA deadband.

F41

Event 1 hold action

F42

Event 2 hold action

F43

Event 3 hold action

F44

Event 4 hold action

EHo1

Use to set an event hold action for the Event 1.

EHo2

Use to set an event hold action for the Event 2.

EHo3

Use to set an event hold action for the Event 3.

EHo4

Use to set an event hold action for the Event 4.

Data range	Factory set value
0: OFF 1: Hold action ON (Only hold action) <ul style="list-style-type: none"> • Validate the hold action when the power is turned on. • Validate the hold action when transferred from STOP (control STOP) to RUN (control RUN). 2: Re-hold action ON (hold and re-hold actions) <ul style="list-style-type: none"> • Validate the hold action when the power is turned on. • Validate the hold action when transferred from STOP (control STOP) to RUN (control RUN). • Validate the re-hold action when the Set value (SV) is changed. However, if the Setting change rate limiter is set to any function other than “0 (0.0)” or in the remote mode, the re-hold action becomes invalid. Re-hold action is only available for deviation high, deviation low, and deviation high/low.	0 If the Event type is specified by the initial setting code when ordering, the factory set value of Event 1 to 4 hold action differs depending on the Event type.

Continued on the next page.

Continued from the previous page.



When high alarm with hold action/re-hold action is used for Event function, alarm does not turn on while hold action is in operation. Use in combination with a high alarm without hold action in order to prevent overheating which may occur by failure of control devices, such as welding of relays.

Related parameters

Parameter setting mode

- Event 1 set value (EV1) to Event 4 set value (EV4) (P. 8-20)
- Event 1 set value (EV1) [high] to Event 4 set value (EV4) [high] (P. 8-20)
- Event 1 set value (EV1') [low] to Event 4 set value (EV4') [low] (P. 8-22)

Engineering mode:

- Event 1 type to Event 4 type (P. 8-101)
- Event 1 differential gap to Event 4 differential gap (P. 8-113)
- Event 1 output action at input burnout to Event 4 output action at input burnout (P. 8-115)
- Energized/De-energized of Event 1 output to Energized/De-energized of Event 4 output (P. 8-116)
- Event 1 timer to Event 4 timer (P. 8-118)
- Event 1 interlock to Event 4 interlock (P. 8-120)

■ Description of function

(1) Hold action

When hold action is ON, the event action is suppressed at start-up or STOP to RUN until the measured value has entered the non-event range.

[With hold action]

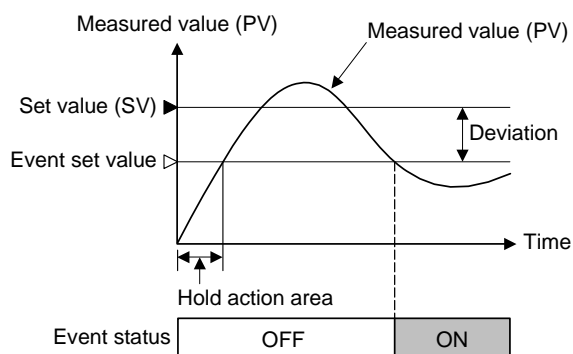

[Without hold action]

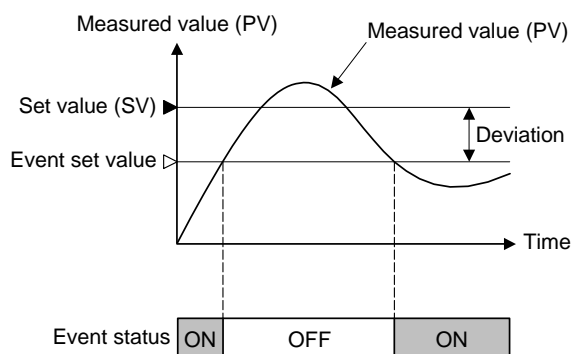

(2) Re-hold action

When re-hold action is ON, the event action is also suppressed at the control set value change until the measured value has entered the non-event range.

Action condition	1: Hold action ON (Only hold action)	2: Re-hold action ON (Hold and re-hold actions)
When the power is turned on	Hold action	Hold action
When transferred from STOP (control STOP) to RUN (control RUN)	Hold action	Hold action
When the set value (SV) is changed	Without hold and re-hold actions	Re-hold action



The re-hold action is invalid for any of the following. However, the hold action is valid.

- When Setting change rate limiter other than “0 (0.0)” are set

[Example] When Event 1 type is the deviation low:

When re-hold action is OFF and event output type is deviation, the event output is produced due to the Set value (SV) change. The re-hold action suppresses the alarm output until the measured value has entered the non-event range again.

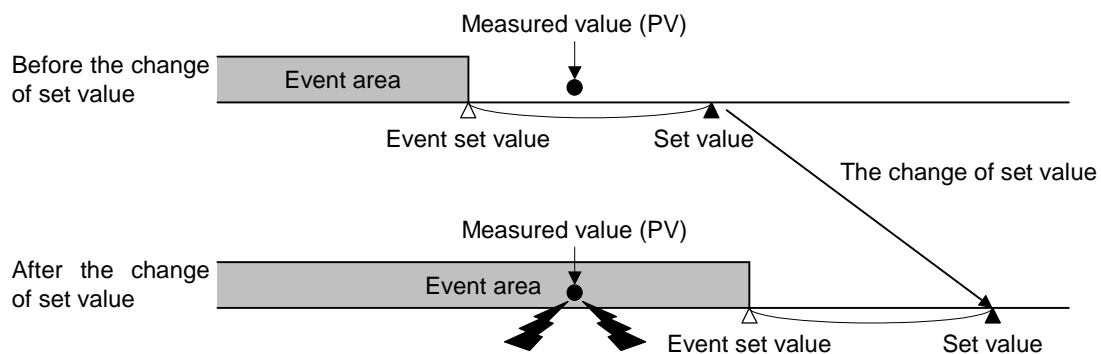

F41

Event 1 differential gap

F42

Event 2 differential gap

F43

Event 3 differential gap

F44

Event 4 differential gap

EH1

Use to set a differential gap of the Event 1.

EH2

Use to set a differential gap of the Event 2.

EH3

Use to set a differential gap of the Event 3.

EH4

Use to set a differential gap of the Event 4.

Data range	Factory set value
0 to Input span	TC/RTD inputs: 2 (2.0) Voltage (V)/Current (I) inputs: 0.2

Related parameters**Parameter setting mode**

- Event 1 set value (EV1) to Event 4 set value (EV4) (P. 8-20)
- Event 1 set value (EV1) [high] to Event 4 set value (EV4) [high] (P. 8-20)
- Event 1 set value (EV1') [low] to Event 4 set value (EV4') [low] (P. 8-22)

Engineering mode:

- Event 1 type to Event 4 type (P. 8-101)
- Event 1 hold action to Event 4 hold action (P. 8-110)
- Event 1 output action at input burnout to Event 4 output action at input burnout (P. 8-115)
- Energized/De-energized of Event 1 output to Energized/De-energized of Event 4 output (P. 8-116)
- Event 1 timer to Event 4 timer (P. 8-118)
- Event 1 interlock to Event 4 interlock (P. 8-120)

■ **Description of function**

It prevents chattering of event output due to the measured value fluctuation around the Event set value.

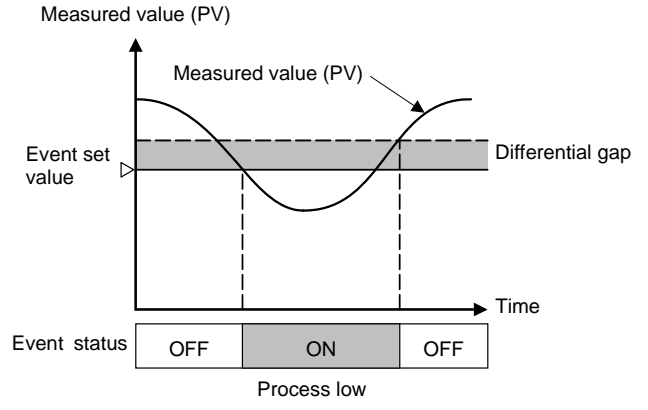
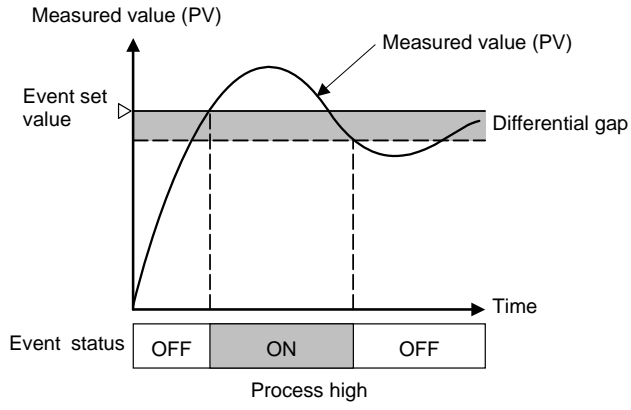

F41

Event 1 output action at input burnout

F42

Event 2 output action at input burnout

F43

Event 3 output action at input burnout

F44

Event 4 output action at input burnout

Ebo1

Use to select the output action of the Event 1 at input burnout.

Ebo2

Use to select the output action of the Event 2 at input burnout.

Ebo3

Use to select the output action of the Event 3 at input burnout.

Ebo4

Use to select the output action of the Event 4 at input burnout.

Data range	Factory set value
0: Event output is not forcibly turned ON when the burnout function is activated.	0
1: ON at over-scale; no action at underscale	
2: ON at underscale; no action at over-scale	
3: ON at over-scale or underscale	
4: OFF at over-scale or underscale	

Related parameters**Parameter setting mode**

- Event 1 set value (EV1) to Event 4 set value (EV4) (P. 8-20)
- Event 1 set value (EV1) [high] to Event 4 set value (EV4) [high] (P. 8-20)
- Event 1 set value (EV1') [low] to Event 4 set value (EV4') [low] (P. 8-22)

Engineering mode:

- Event 1 type to Event 4 type (P. 8-101)
- Event 1 hold action to Event 4 hold action (P. 8-110)
- Event 1 differential gap to Event 4 differential gap (P. 8-113)
- Energized/De-energized of Event 1 output to Energized/De-energized of Event 4 output (P. 8-116)
- Event 1 timer to Event 4 timer (P. 8-118)
- Event 1 interlock to Event 4 interlock (P. 8-120)

F41

Energized/De-energized of Event 1 output

F42

Energized/De-energized of Event 2 output

F43

Energized/De-energized of Event 3 output

F44

Energized/De-energized of Event 4 output

EXC1

Use to select the Energized or De-energized for the digital output 1 (DO1). However, the FAIL alarm is fixed to “De-energized.” (When at FAIL alarm occurrence: Contact opened)

EXC2

Use to select the Energized or De-energized for the digital output 2 (DO2). However, the FAIL alarm is fixed to De-energized. (When at FAIL alarm occurrence: Contact opened)

EXC3

Use to select the Energized or De-energized for the digital output 3 (DO3). However, the FAIL alarm is fixed to De-energized. (When at FAIL alarm occurrence: Contact opened)

EXC4

Use to select the Energized or De-energized for the digital output 4 (DO4). However, the FAIL alarm is fixed to De-energized. (When at FAIL alarm occurrence: Contact opened)

Data range	Factory set value
0: Energized 1: De-energized	0

Related parameters**Parameter setting mode**

- Event 1 set value (EV1) to Event 4 set value (EV4) (P. 8-20)
- Event 1 set value (EV1) [high] to Event 4 set value (EV4) [high] (P. 8-20)
- Event 1 set value (EV1') [low] to Event 4 set value (EV4') [low] (P. 8-22)

Engineering mode:

- Event 1 type to Event 4 type (P. 8-101)
- Event 1 hold action to Event 4 hold action (P. 8-110)
- Event 1 differential gap to Event 4 differential gap (P. 8-113)
- Event 1 output action at input burnout to Event 4 output action at input burnout (P. 8-115)
- Event 1 timer to Event 4 timer (P. 8-118)
- Event 1 interlock to Event 4 interlock (P. 8-120)

■ Description of function

Energized: Relay contact is closed during the event or alarm.

De-energized: Relay contact opens during the event or alarm.

Diagram for explaining operation (At power-ON)

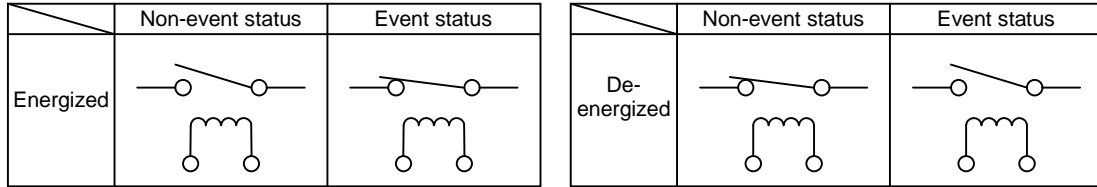

F41

Event 1 timer

F42

Event 2 timer

F43

Event 3 timer

F44

Event 4 timer

EVΓ1

Event 1 timer is to set an output delay time for event outputs.

EVΓ2

Event 2 timer is to set an output delay time for event outputs.

EVΓ3

Event 3 timer is to set an output delay time for event outputs.

EVΓ4

Event 4 timer is to set an output delay time for event outputs.

Data range	Factory set value
0 to 600 seconds	0

Related parameters

Parameter setting mode

- Event 1 set value (EV1) to Event 4 set value (EV4) (P. 8-20)
- Event 1 set value (EV1) [high] to Event 4 set value (EV4) [high] (P. 8-20)
- Event 1 set value (EV1') [low] to Event 4 set value (EV4') [low] (P. 8-22)

Engineering mode:

- Event 1 type to Event 4 type (P. 8-101)
- Event 1 hold action to Event 4 hold action (P. 8-110)
- Event 1 differential gap to Event 1 differential gap (P. 8-113)
- Event 1 output action at input burnout to Event 4 output action at input burnout (P. 8-115)
- Energized/De-energized of Event 1 output to Energized/De-energized of Event 4 output (P. 8-116)
- Event 1 interlock to Event 4 interlock (P. 8-118)

■ Description of function

When an event condition becomes ON, the output is suppressed until the Event timer set time elapses. If the event output is still ON after time is up, the output will resume.

Example: When the setting of Event 1 timer is 50 seconds

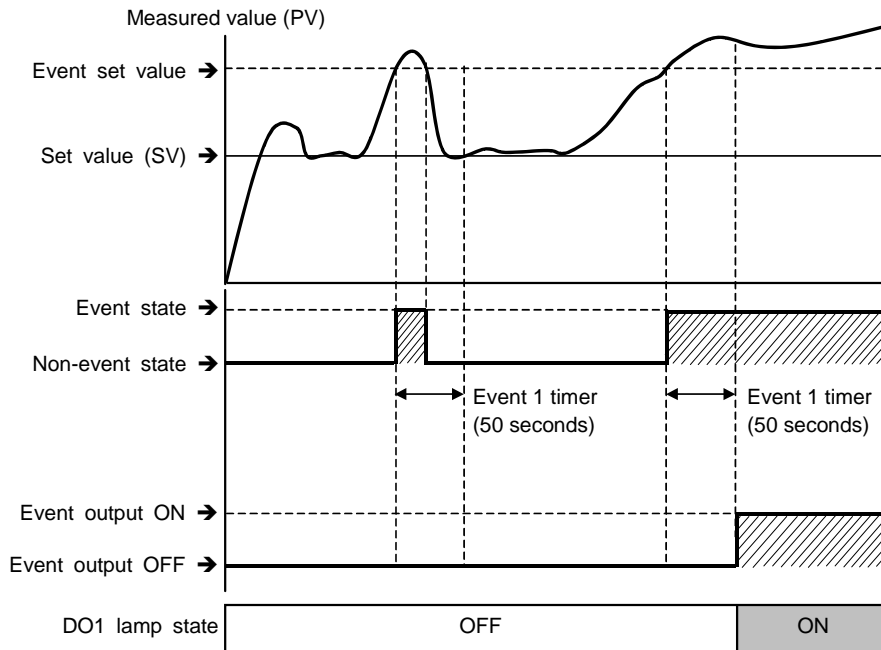

The Event timer is also activated for the following reasons:

- When set to the event state simultaneously with power turned on
- When set to the event state simultaneously with control changed to RUN (control start) from STOP (control stop).



In the event wait state, no event output is turned on even after the Event timer preset time has elapsed.



The Event timer is reset for the following reasons:

- When power failure occurs while the Event timer is being activated
- When control is changed to STOP (control stop) from RUN (control start) while the Event timer is being activated

F41

Event 1 interlock

F42

Event 2 interlock

F43

Event 3 interlock

F44

Event 4 interlock

E1L1

Use to select the Interlock function for the Event 1.

E1L2

Use to select the Interlock function for the Event 2.

E1L3

Use to select the Interlock function for the Event 3.

E1L4

Use to select the Interlock function for the Event 4.

Data range	Factory set value
0: Unused (OFF) 1: Used	0

Related parameters

Mode switching

- Interlock release (P. 8-11)

Parameter setting mode

- Event 1 set value (EV1) to Event 4 set value (EV4) (P. 8-20)
- Event 1 set value (EV1) [high] to Event 4 set value (EV4) [high] (P. 8-20)
- Event 1 set value (EV1') [low] to Event 4 set value (EV4') [low] (P. 8-22)

Engineering mode:

- Event 1 type to Event 4 type (P. 8-101)
- Event 1 hold action to Event 4 hold action (P. 8-110)
- Event 1 differential gap to Event 4 differential gap (P. 8-113)
- Event 1 output action at input burnout to Event 4 output action at input burnout (P. 8-115)
- Energized/De-energized of Event 1 output to Energized/De-energized of Event 4 output (P. 8-116)
- Event 1 timer to Event 4 timer (P. 8-118)

■ Description of function

The Event interlock function is used to hold the event state.

[Example] When the Event interlock function is used for deviation high

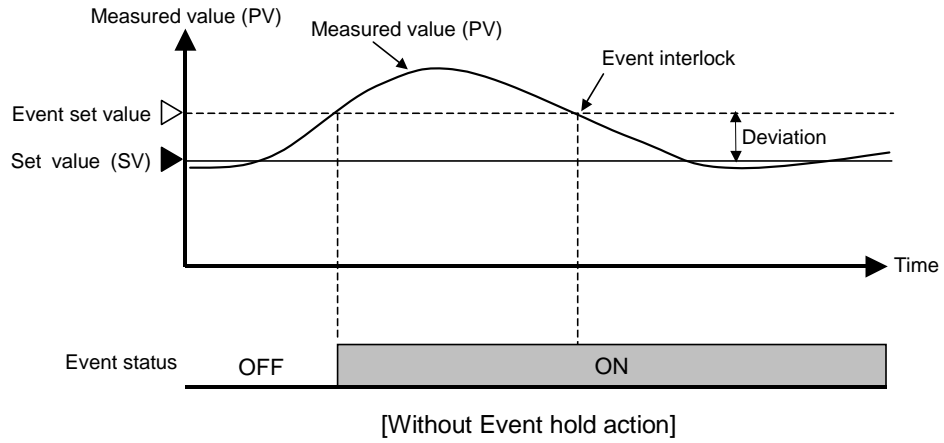

Function block 45 (F45)

F45.

This is the first parameter symbol of Function block 45 (F45).

The settings of parameters in this group are valid only when the CT input (optional) function is specified.

In addition, digital output (optional) must be specified for the Heater break alarm to function.



If the output 1 (OUT1) is current output or voltage output, the CT input (optional) cannot be used.

F45

CT ratio (Number of turns)

CTR

Use to set the Number of turns in the current transformer used to monitor the current flowing through the load. There are two types of dedicated current transformers.

Data range	Factory set value
1 to 1000	When the current transformer type is CTL-6-P-N: 800 When the current transformer type is CTL-12-S56-10L-N: 1000

Related parameters

Parameter setting mode:

- Heater break alarm 1 (HBA1) set value (P. 8-31)
- Heater break alarm 2 (HBA2) set value (P. 8-31)

Engineering mode:

- Number of HBA delay times (P. 8-123)

F45

Number of HBA delay times

HbC

To prevent false alarming, the alarm function will wait to produce an alarm until the measured CT input value is in the alarm range for the preset number of consecutive sampling cycles.

Data range	Factory set value
0 to 255	3

Related parameters

Parameter setting mode:

- Heater break alarm 1 (HBA1) set value (P. 8-31)
- Heater break alarm 2 (HBA2) set value (P. 8-31)

Engineering mode:

- CT ratio (P. 8-122)

■ Description of function

Heater break alarm (HBA) delay time = Number of delay times × Sampling time *

* The shortest cycle of sampling is 1 second. Depending on the load rate, there may be a difference in the HBA delay time.

Example:

Sampling time: 1 second

Number of delay times: 3 times (factory set value)

$$\text{HBA delay time} = 3 \text{ times} \times 1 \text{ second} = 3 \text{ seconds}$$

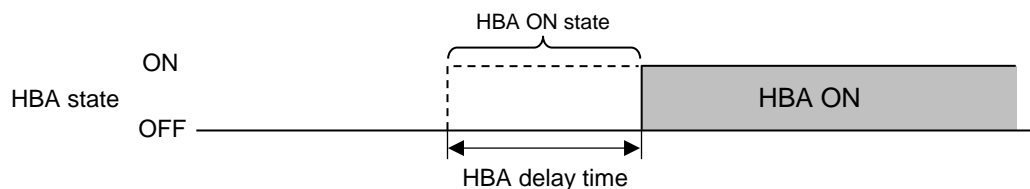

Function block 51 (F51)

F51.

This is the first parameter symbol of Function block 51 (F51).

F51

Direct/Reverse action

05

This parameter setting is only a for PID control with Autotuning (AT).

Data range	Factory set value
0: Direct action 1: Reverse action	Based on model code

■ Description of function

● PID control (direct action)

The Manipulated output value (MV) increases as the Measured value (PV) increases.
This action is used generally for cool control.

● PID control (reverse action)

The Manipulated output value (MV) decreases as the Measured value (PV) increases.
This action is used generally for heat control.

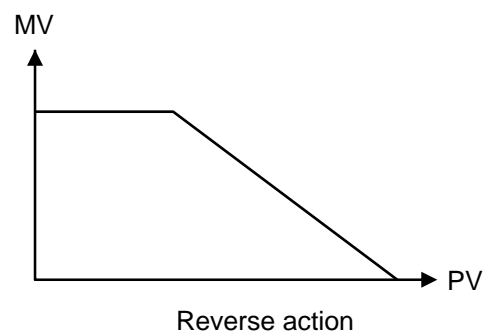
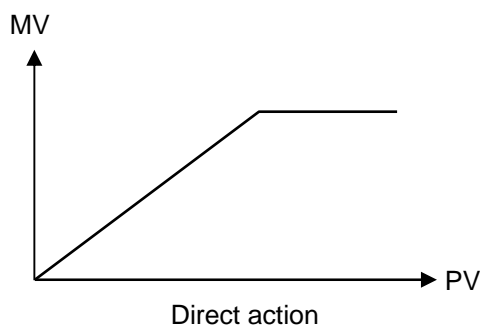

F51

Cool action

05c

Use to select the Cool action type of Heat/Cool PID control with AT.

Data range	Factory set value
0: Air cooling (For Extruder)	Based on model code
1: Water cooling (For Extruder)	
2: Cooling gain linear	

■ Description of function

● Heat/Cool PID control

With Heat/Cool PID control method, heat-side and cool-side can be controlled by a controller.

For example, this is effective when cool control is required in extruder cylinder temperature control.

Water cooling/Air cooling: The algorithm assuming plastic molding machine Heat/Cool control is employed. Even in equipment provided with a cooling mechanism having nonlinear characteristics, it responds quickly to attain the characteristic responding to the set value with small overshooting.

Cooling linear type: The algorithm assuming applications without nonlinear cooling capability is employed.

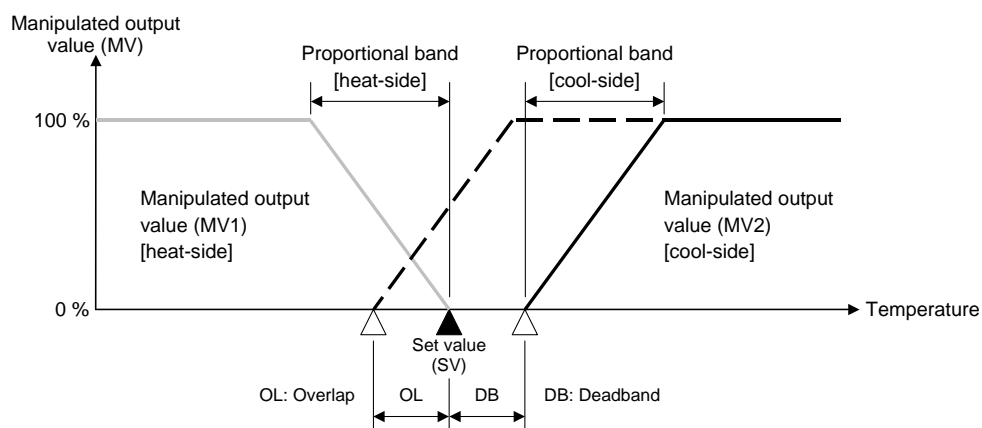

F51

ON/OFF action differential gap (upper)

ON/OFF action differential gap (lower)

oHH

ON/OFF action differential gap (upper):

Use to set the ON/OFF control differential gap (upper).

oHL

ON/OFF action differential gap (lower):

Use to set the ON/OFF control differential gap (lower).

Data range	Factory set value
TC/RTD inputs: 0 (0.0) to 100 (100.0) °C [°F]	1 (1.0)
Voltage (V)/Current (I) inputs: 0.0 to 10.0 % of Input span	0.1 % of Input span

Related parameters

Parameter setting mode:

- Proportional band [heat-side] (P. 8-26)

■ **Description of function**

ON/OFF control is possible when the Proportional band is set to “0” or “0.0.” In ON/OFF control with Reverse action, when the Measured value (PV) is smaller than the Set value (SV), the Manipulated output (MV) is 100 % or ON. When the PV is higher than the SV, the MV is 0 % or OFF.

Differential gap setting prevents control output from repeating ON and OFF too frequently.

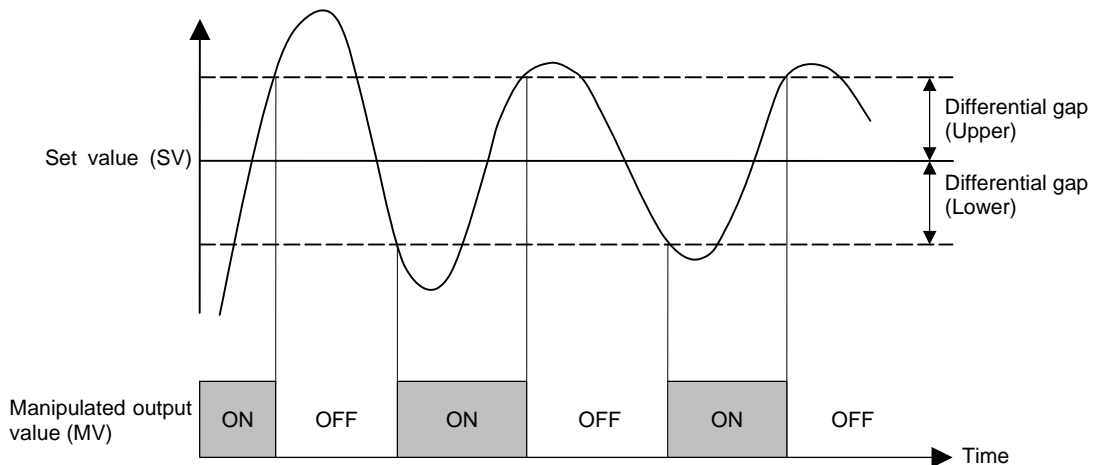

F51

Control output at burnout

obo

This sets the action when burnout occurs.

Data range	Factory set value
0: Result of control computation 1: Low output limiter value (Output OFF) * * In case of Heat/Cool PID control type both heating and cooling outputs are off.	0

F51

Bumpless mode setting

bump

This function is used to prevent overload caused by the Manipulated output value (MV) suddenly changing when Auto mode is transferred to Manual mode and vice versa.

Data range	Factory set value
0: Without bumpless 1: With bumpless	1

Related parameters

Mode switching:

- Auto (AUTO)/Manual (MAN) transfer (P. 8-10)

 For details of balanceless/bumpless, refer to **6.5 Auto/Manual transfer (P. 6-20)**.

F51

Derivative action

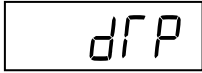

Use to select the action of derivative term.

Data range	Factory set value
0: Measured value derivative 1: Deviation derivative	0

Related parameters

Parameter setting mode:

- Autotuning (AT) (P. 8-24)

■ Description of function

Measured value derivative: PID control putting emphasis on response most adaptive to fixed set point control (mode)

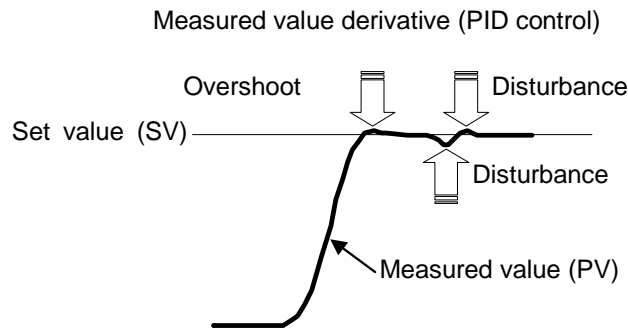

Deviation derivative:

PID control putting emphasis on follow-up most adaptive to ramp control or cascade control using a ratio of setting change limiter, etc. It is effective to restrict speed deviation in ramp control and to restrict the amount of overshooting when changed to “soak” from “ramp.”

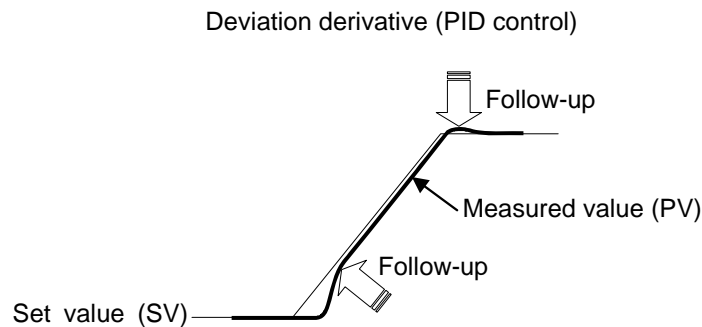

F51

Time setting of proportional cycle time [heat-side]**Time setting of proportional cycle time [cool-side]**

FU

Time setting of proportional cycle time [heat-side]:

When Proportional cycle time [heat-side] is set to 0 seconds in the Parameter setting mode, this setting item becomes valid for the Proportional cycle time [heat-side].

EU

Time setting of proportional cycle time [cool-side]:

When Proportional cycle time [cool-side] is set to 0 seconds in the Parameter setting mode, this setting item becomes valid for the Proportional cycle time [cool-side].

Data range	Factory set value
0: 0.1 seconds (fixed)	2
1: 0.25 seconds (fixed)	
2: 0.5 seconds (fixed)	

Related parameters

Parameter setting mode:

- Proportional cycle time [heat-side] (P. 8-36)
- Proportional cycle time [cool-side] (P. 8-39)

Function block 52 (F52)

F52.

This is the first parameter symbol of Function block 52 (F52).

F52

AT cycles

ATC

The number of ON/OFF cycles is selected when the Autotuning (AT) function is executed.

Data range	Factory set value
0: 1.5 cycles 1: 2.5 cycles	0

Related parameters

Parameter setting mode:

- Autotuning (AT) (P. 8-24)

■ Example

When the AT cycle is set to 1.5 cycle and the Autotuning (AT) function is executed just after the power is turned on.

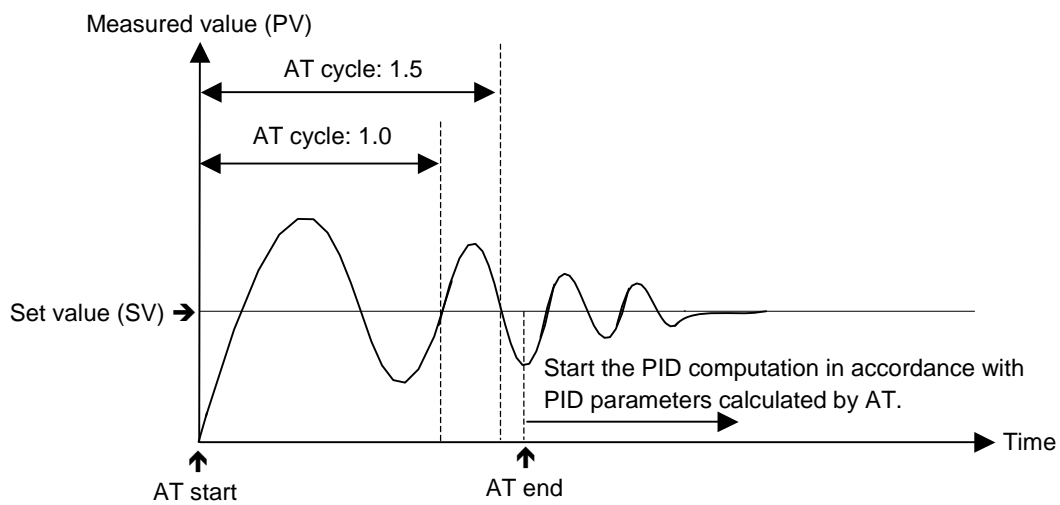

F52

AT differential gap time

ATH

Use to set an ON/OFF action differential gap time for Autotuning (AT).
This function prevents the AT function from malfunctioning caused by noise.

Data range	Factory set value
0 to 50 seconds	10

Related parameters

Parameter setting mode:

- Autotuning (AT) (P. 8-24)

■ Description of function

In order to prevent the output from chattering due to the fluctuation of a Measured value (PV) caused by noise during autotuning, the output on or off state is held until “AT differential gap time” has passed after the output on/off state is changed to the other. Set “AT differential gap time” to “ $1/100 \times$ Time required for temperature rise.”

[Example]

A: AT cycle time when the AT differential gap time is set to 0 seconds

The output chatters due to the fluctuation of the Measured value (PV) caused by noise, and autotuning function is not able to monitor appropriate cycles to calculate suitable PID values.

B: AT cycle time when the AT differential gap time is set to “Time corresponding to 0.25 cycles.”

The fluctuation of a Measured value (PV) caused by noise is ignored and the Autotuning function is able to monitor appropriate cycles to calculate suitable PID values.

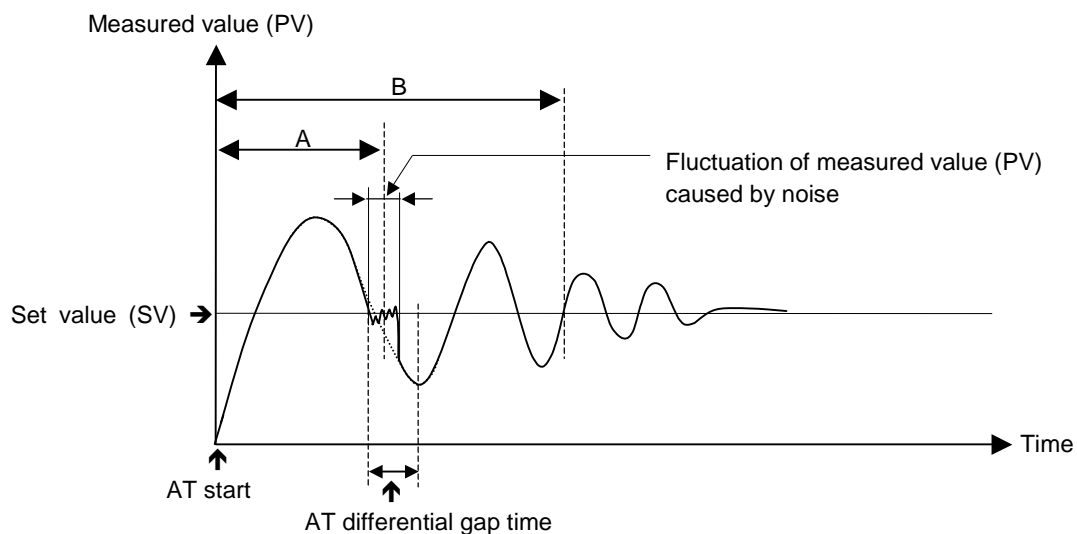

The factory set value of the AT cycle is 1.5 cycles.

F52

ST start condition

575

Timing (starting condition) to activate the Startup tuning (ST) function is selected.

Data range	Factory set value
0: Activate the ST function when the power is turned on; when transferred from STOP to RUN; or when the Set value (SV) is changed.	0
1: Activate the ST function when the power is turned on; or when transferred from STOP to RUN.	
2: Activate the ST function when the Set value (SV) is changed.	

Related parameters

Parameter setting mode:

- Startup tuning (ST) (P. 8-25)

 For details of Startup tuning (ST), refer to **6.3 Startup Tuning (ST) (P. 6-11)**.

Function block 60 (F60)

F60.

This is the first parameter symbol of Function block 60 (F60).
The settings of parameters in this block require the Communication function (optional) to be specified.

F60

Communication protocol

CMPS

Use to select the protocol for Communication function.

Data range	Factory set value
0: RKC communication	Based on model code
1: Modbus	

 For the Communication function, refer to the **Communication Instruction Manual (IMR02C16-E□)**.

Related parameters

Engineering mode:

- Device address (P. 8-133)
- Data bit configuration (P. 8-134)
- Communication speed (P. 8-134)
- Interval time (P. 8-135)
- Communication response monitor (P. 8-135)

F60

Device address

Add

Device address is used to set the slave address of the controller for Communication function.

Data range	Factory set value
0 to 99 (Modbus: 1 to 99)	RKC communication: 0 Modbus: 1

 **Do not use the same Device address for more than one controller in multi-drop connection. Each controller must have a unique address in multi-drop connection.**

 **If the protocol is Modbus, no “0” can be set.**

 For the Communication function, refer to the **Communication Instruction Manual (IMR02C16-E□)**.

F60

Communication speed

bps

Communication speed is to set Communication speed for Communication function.

Data range	Factory set value
0: 2400 bps 1: 4800 bps 2: 9600 bps 3: 19200 bps	3

 For the Communication function, refer to the **Communication Instruction Manual (IMR02C16-E□)**.

F60

Data bit configuration

bit

This item is Data bit configuration of Communication function.

Set value	Data bit configuration			Modbus Communication	RKC Communication
	Data	Parity	Stop		
0	8	Without	1	Selectable	Selectable
1	8	Without	2		
2	8	Even	1		
3	8	Even	2		
4	8	Odd	1		
5	8	Odd	2		
6	7	Without	1	Not selectable	
7	7	Without	2		
8	7	Even	1		
9	7	Even	2		
10	7	Odd	1		
11	7	Odd	2		

Factory set value: 0 (Data bit: 8, Parity bit: Without, Stop bit: 1)

 For the Communication function, refer to the **Communication Instruction Manual (IMR02C16-E□)**.

F60

Interval time

[Inf]

This item is Interval time of Communication function.

Data range	Factory set value
0 to 250 ms	10

 For the Communication function, refer to the **Communication Instruction Manual (IMR02C16-E□)**.

F60

Communication response monitor

[CRRM]

This is the communication error. If two or more errors happen, the sum of errors will be displayed.

Data range	Factory set value
0: Normal response 1: Overrun error 2: Parity error 4: Framing error 8: Receive buffer overflow	0

 For the Communication function, refer to the **Communication Instruction Manual (IMR02C16-E□)**.

Function block 70 (F70)

F70.

This is the first parameter symbol of Function block 70 (F70).

F70

Setting change rate limiter unit time

SVRF

Set the time unit for Setting change rate limiter (up/down).

Data range	Factory set value
0: Minute	0
1: Hours	

Related parameters

Parameter setting mode:

- Setting change rate limiter (up), Setting change rate limiter (down) (P. 8-66)

F70

Timer time unit

TMU

Set the time unit for Timer.

Data range	Factory set value
0: Min.: sec.	0
1: Hour: min.	

Related parameters

Parameter setting mode:

- Timer 1 to Timer 4 (P. 8-63)

Function block 91 (F91)

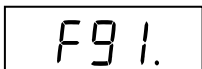

This is the first parameter symbol of Function block 91 (F91).

F91

ROM version monitor



Displays the version of loaded software.

Display range	Factory set value
Version of ROM built in the controller	—

F91

Integrated operating time monitor

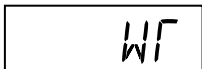

Displays the Integrated total operating time of the controller.

Display range	Factory set value
0 to 9999 hours	—

F91

Holding peak value ambient temperature monitor

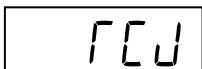

Displays the maximum ambient temperature of the instrument.

Display range	Factory set value
-10 to +100 °C (14 to 212 °F)	—

MEMO

TROUBLE SHOOTING

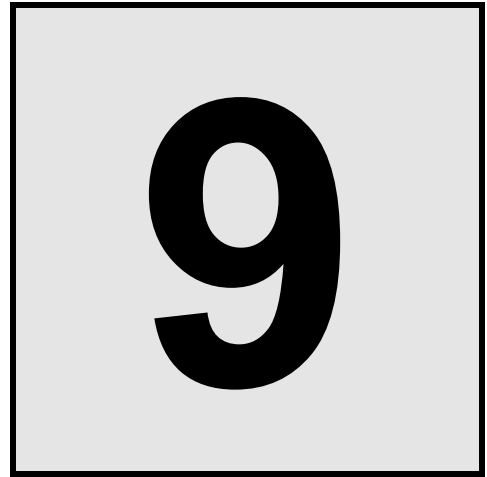

This chapter describes error displays and procedures to follow when problems occur.

9.1 Error Display	9-2
9.2 Solutions for Problems.....	9-4

9.1 Error Display

This Section describes error display when the measured value (PV) exceeds the display range and the self-diagnostic error.

■ Display when input error occurs

The table below shows displays, description, control actions and solutions when the measured value (PV) exceeds the display range.

 **Prior to replacing the sensor, always turn the power OFF or change to STOP with RUN/STOP transfer.**

Display	Description	Action (Output)	Solution
Measured value (PV) [Flashing]	Measured value (PV) exceeds the input range. Display does not flash when “Non-flashing display” is set.	<ul style="list-style-type: none"> Control output: Output depending on the “Control output at burnout” (Refer to P. 8-127.) 	Check Input type, Input range and connecting state of sensor. Confirm that the sensor or wire is not broken.
□□□□ [Flashing]	Over-scale Measured value (PV) is above the display range limit high.	<ul style="list-style-type: none"> Event output: Output depending on the “Event output state at input burnout” (Refer to P. 8-115.) 	
UUUUU [Flashing]	Underscale Measured value (PV) is below the display range limit low.		

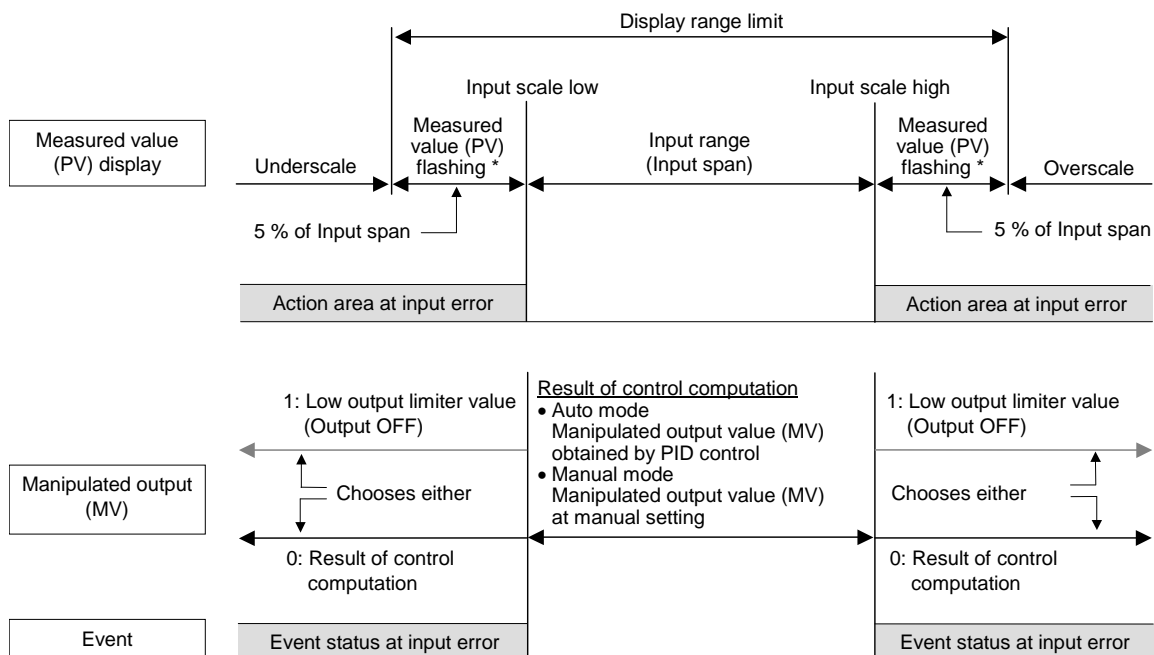

* “PV flashing display at input error (P. 8-94)” of PV can be selected for the PV flashing display at input error of the Engineering mode (F21).

■ Self-diagnostic error

In an error is detected by the self-diagnostic function, the PV display shows “Err,” and the SV display shows the error code. If two or more errors occur simultaneously, the total summation of these error codes is displayed.

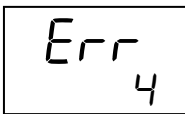
Error number	Description	Action	Solution
1	Adjusted data error • Adjusted data range is abnormal.	Display: Error display (Err) Control output: Time-proportional control output: OFF Continuous control output: Output of -5 % Transmission output: Output of -5 % FAIL output: Contact open [When FAIL is selected for the event (EV)] Communication: Possible <Example of error display> 	Turn off the power once. If the RB100/400/500/700/900 is restored to normal after the power is turned on again, then probable cause may be external noise source affecting the control system. Check for the external noise source. If an error occurs after the power is turned on again, the RB100/400/500/700/900 must be repaired or replaced. Please contact RKC sales office or the agent.
2	Data back-up error • Back-up action is abnormal. • Data write failure		
4	A/D conversion error • Response signal from A/D converter is abnormal. Temperature compensation error • Temperature measuring range (+100 °C or more, -20 °C or less) is abnormal.		

If any of the following errors occur, all action of the RB100/400/500/700/900 is stopped. In this case the error number is not displayed.

Description	Action	Solution
Power supply voltage is abnormal (power supply voltage monitoring)	Display: All display is OFF Control output: Time-proportional control output: OFF Continuous control output: Output of -5 % Transmission output: Output of -5 % FAIL output: Contact open [When FAIL is selected for the event (EV)] Communication: No response	The RB100/400/500/700/900 must be repaired or replaced. Please contact RKC sales office or the agent.
Watchdog timer • The part of an internal program stops the action.		

9.2 Solutions for Problems

This section explains probable causes and solutions if any abnormality occurs in the instrument. For any inquiries or to confirm the specifications of the product, please contact RKC sales office or the agent.

If it is necessary to replace a device, always strictly observe the warnings below.



WARNING

- To prevent electric shock or instrument failure, always turn off the system power before replacing the instrument.
- To prevent electric shock or instrument failure, always turn off the power before mounting or removing the instrument.
- To prevent electric shock or instrument failure, do not turn on the power until all wiring is completed. Make sure that the wiring is correct before applying power to the instrument.
- To prevent electric shock or instrument failure, do not touch the inside of the instrument.
- All wiring must be performed by authorized personnel with electrical experience in this type of work.

CAUTION

All wiring must be completed before power is turned on to prevent electric shock, instrument failure, or incorrect action. The power must be turned off before repairing work for input break and output failure including replacement of sensor, contactor or SSR, and all wiring must be completed before power is turned on again.

■ Display

Problem	Probable cause	Solution
No display appears	The internal assembly is not inserted into the case correctly.	Insert the internal assembly into the case correctly.
	Power supply terminal connection not correct.	Connect the terminals correctly by referring to 3.3 Wiring of Each Terminal (P. 3-8) .
	Power supply terminal contact defect.	Retighten the terminals
	Proper power supply voltage is not being supplied.	Apply the normal power supply by referring to 10. SPECIFICATIONS (P. 10-1) .
Display is abnormal	Noise source is present near the instrument.	Separate the noise source from the instrument. Set the appropriate digital filter according to the responding control systems.
	The terminal board on the instrument using the thermocouple is directly exposed to the air from an air conditioner.	Do not directly expose the terminal board to the air from the air conditioner.
Measured value (PV) display differs from the actual value	Proper sensor is not being used.	Use the specified sensor.
	The PV bias is set.	Set the PV bias to "0 (0.0)" by referring to PV bias (P. 8-41) . However, this is limited only to when the PV bias setting can be changed.



How to check if the input function of the controller is working correctly.

- When the controller is configured as Thermocouple input:
Short the input terminals No. 17 and No. 18 for RB700 or No. 11 and No. 12 for RB100, RB400, RB500 and RB900. If the controller shows a Measured value around the ambient temperature of the input terminals, the input function of the controller is working correctly.
- When the controller is configured as RTD input:
Connect a 100 Ω resistor between the input terminals No. 16 and No. 17 for RB700 or No. 10 and No. 11 for RB100, RB400, RB500 and RB900, and short the input terminals No. 17 and No. 18 for RB700 or No. 11 and No. 12 for RB100, RB400, RB500 and RB900. If the controller shows Measured value around 0 °C (32 °F), the input function of the controller is working correctly.
- When the controller is configured as Voltage/Current input:
Input a certain voltage or current from a voltage/current generator to the controller. If the controller shows the equivalent input value, the input setting and function of the controller is working correctly.

■ Control

Problem	Probable cause	Solution
Control is abnormal	The power supply is not correct.	Apply the normal power supply by referring to 10. SPECIFICATIONS (P. 10-1) .
	Sensor or input lead wires break.	Turn off the power or STOP the operation by “RUN/STOP transfer” and repair the sensor or replace it.
	The sensor is not wired correctly.	Conduct sensor wiring correctly by referring to 3.3 Wiring of Each Terminal (P. 3-8) .
	Proper sensor is not being used.	Use the specified sensor.
	Sensor insertion depth is insufficient.	Check whether sensor is inserted too loosely. If so, fully insert the sensor.
	Sensor insertion position is not appropriate.	Insert the sensor at the specified location.
	Input signal wires are not separated from instrument power and/or load wires.	Separate each wire.
	Noise source is present near the wiring.	Separate the noise source from the wiring.
	Inappropriate PID constants	Set the appropriate PID constants.
Startup tuning (ST) function cannot be activated	Startup tuning (ST) mode is “0 (ST unused).” (Factory set value: 0)	Refer to 6.3 Startup Tuning (ST) (P. 6-11) .
	Requirements for performing the Startup tuning (ST) function are not satisfied.	Satisfy the requirements for performing the Startup tuning (ST) function by referring to 6.3 Startup Tuning (ST) (P. 6-11) .

Continued on the next page.

Continued from the previous page.

Problem	Probable cause	Solution
Autotuning (AT) function not activated	Requirements for performing the Autotuning (AT) function are not satisfied.	Satisfy the requirements for performing the Autotuning (AT) function by referring to 6.2 Autotuning (AT) (P. 6-8) .
Autotuning (AT) suspended	Requirements for suspending the Autotuning (AT) function are established.	Identify causes for Autotuning (AT) suspension by referring to 6.2 Autotuning (AT) (P. 6-8) and then remove them. Then, execute the Autotuning (AT) function again.
Acceptable PID values cannot be calculated by Autotuning (AT)	The Autotuning (AT) function does not appropriately meet the characteristics of the controlled object.	Set PID constants manually.
Autotuning (AT) cannot be finished normally	A temperature change (UP and/or Down) is 1 °C or less per minute during Autotuning.	Set PID constants manually.
	Autotuning (AT) is activated when the set value is around the ambient temperature or is close to the maximum temperature achieved by the load.	
Output does not change.	The Output limiter is set.	Change the Output limiter setting by referring to Output limiter (high/low) (P. 8-38) . However, this is limited only to when the Output limiter setting can be changed.

■ Operation

Problem	Probable cause	Solution
No control RUN can be made by key operation (Digital input: either DI1 or DI2)	RUN/STOP transfer of the Digital input (DI) is set to the contact opened.	Check the contact state of RUN/STOP transfer by referring to 6.1 RUN/STOP Transfer (P. 6-2) .
No Manual mode can be made by key operation. (Digital input: either DI1 or DI2)	Auto/Manual transfer of the digital input (DI) is set to the contact opened.	Check the contact state of Auto/Manual transfer by referring to 6.5 Auto/Manual Transfer (P. 6-20) .
No setting change can be made by key operation.	Set data is locked.	Release the set data lock by referring to 6.6 Protecting Setting Data (P. 6-24) .
Set value does not change.	The Setting limiter is set.	Change the Setting limiter setting by referring to Setting limiter (high/low) (P. 8-93) . However, this is limited only to when the Setting limiter setting can be changed.
Set value (SV) does not change immediately when the Set value (SV) is changed	The Setting change rate limiter is set.	Set the Setting change rate limiter to "0 (0.0)" by referring to Setting change rate limiter (up/down) (P. 8-18) . However, this is limited only to when the Setting limiter setting can be changed.

■ Event function

Problem	Probable cause	Solution
Event function is abnormal	Event function is different from the specification.	Change the Event action type by referring to Event type (P. 8-101) after the instrument specification is confirmed.
	Digital output (DO) relay contact Energized/De-energized is reversed. When FAIL is selected for digital output: De-energized fixed: Contact opens under FAIL	Check the setting details by referring to Energized/De-energized (P. 8-116) .
	Setting of Event differential gap is not appropriate.	Set the appropriate Event differential gap by referring to Event differential gap (P. 8-113) .
Event hold action is not activated.	The Setting change rate limiter is set.	Set the Setting change rate limiter to “0 (0.0)” by referring to Setting change rate limiter (up/down) (P. 8-18) . However, this is limited only to when the Setting limiter setting can be changed.

■ Heater break alarm (HBA)

Problem	Probable cause	Solution
No heater break can be detected	Setting of Heater break alarm is not appropriate.	Set the appropriate Heater break alarm value.
	The CT is not connected.	Connect the CT by referring to 3.3 Wiring of Each Terminal (P. 3-8) .
CT input value is abnormal	Proper CT is not used.	Use the specified CT.
	The heater is broken.	Check the heater.
	CT wired improperly.	Conduct CT wiring correctly by referring to 3.3 Wiring of Each Terminal (P. 3-8) .
	Input terminal contact defect.	Retighten the terminals.

MEMO

SPECIFICATIONS



■ Measured input

Number of input:	1 point
Input type:	TC input: K, J, T, S, R, E, B, N (JIS-C1602-1995) PL II (NBS), W5Re/W26Re (ASTM-E988-96)
	RTD: Pt100 (JIS-C1604-1997) JPt100 (JIS-C1604-1997, JIS-C1604-1981 of Pt100) 3-wire system
	Voltage: 0 to 1 V DC, 0 to 5 V DC, 1 to 5 V DC, 0 to 10 V DC
	Current: 0 to 20 mA DC, 4 to 20 mA DC (Connect a 250 Ω shunt resistor to the input terminals)

Input range:

TC input

Input type	Measured range
K	-199.9 to +400.0 °C, 0.0 to +800.0 °C, -200 to +1372 °C, -100.0 to +752.0 °F, -328 to +2501 °F (Accuracy is not guaranteed for less than -100 °C)
J	-199.9 to +300.0 °C, -200 to +1200 °C, -199.9 to +550.0 °F, -328 to +2192 °F (Accuracy is not guaranteed for less than -100 °C)
T	-199.9 to +300.0 °C, 0.0 to 400.0 °C, -200 to +400 °C, -199.9 to +300.0 °F, 0.0 to 600.0 °F, -328 to +752 °F (Accuracy is not guaranteed for less than -100 °C)
S	0 to 1769 °C, 0 to 3216 °F (Accuracy is not guaranteed for less than 400 °C)
R	0 to 1769 °C, 0 to 3216 °F (Accuracy is not guaranteed for less than 400 °C)
E	0 to 1000 °C, 0 to 1832 °F
B	0 to 1820 °C, 0 to 3308 °F (Accuracy is not guaranteed for less than 400 °C)
N	0 to 1300 °C, 0 to 2372 °F
PLII	0 to 1390 °C, 0 to 2534 °F
W5Re/W26Re	0 to 2320 °C, 0 to 4208 °F (Accuracy is not guaranteed for less than 400 °C)

RTD input

Input type	Measured range
Pt100	-199.9 to +649.0 °C, -199.9 to +900.0 °F
JPt100	-199.9 to +649.0 °C, -199.9 to +900.0 °F

Voltage/Current inputs

Input type	Measured range
Voltage	0 to 1 V DC, 0 to 5 V DC, 1 to 5 V DC, 0 to 10 V DC
Current	0 to 20 mA DC, 4 to 20 mA DC (Connect a 250 Ω shunt resistor to the input terminals)
	Programmable range -1999 to +9999 [The decimal point position is selectable] (Factory set value: 0.0 to 100.0 %)

Sampling cycle: 250 ms

Influence of external resistance:

Approx. 0.25 $\mu\text{V}/\Omega$ (Converted depending on TC types)

Influence of input lead: Approx. 0.02 %/ Ω of span (Only RTD)

10 Ω or less per wire

Input impedance:

TC input: 1 M Ω or more

Voltage input: Approx. 1 M Ω

Current input: Approx. 250 Ω

(Connect a 250 Ω shunt resistor to the input terminals)

Sensor current:

Approx. 200 μA (Only RTD)

Action at input break:

TC input: Upscale or downscale
(Select one of these)

RTD input: Upscale

Voltage input: Downscale or Indicates the value near 0

Current input: Downscale or Indicates the value near 0

Action at input short circuit:

Downscale (RTD input)

Input correction:

PV bias: -1999 to +9999 $^{\circ}\text{C}$ [$^{\circ}\text{F}$] or -199.9 to +999.9 $^{\circ}\text{C}$ [$^{\circ}\text{F}$]
(TC/RTD inputs)

-Input span to +Input span (Voltage/Current inputs)

PV digital filter (First order lag digital filter):

0 to 100 seconds (0: Filter OFF)

■ **Current transformer (CT) input [optional]**

Number of input: 2 points

CT type: CTL-6-P-N or CTL-12-S56-10-N (Sold separately)

Input range: 0.0 to 0.1 Arms

Measurement current range:

CTL-6-P-N: 0.0 to 30.0 A

CTL-12-S56-10L-N: 0.0 to 100.0 A

Sampling cycle: 1 second

CT ratio (Number of turns):

1 to 1000

CTL-6-P-N: 800

CTL-12-S56-10L-N: 1000

■ Digital input (DI) [optional]

Number of input: 2 points (DI1, DI2) Isolated input

Input method: Dry contact input:
Open state: 500 k Ω or more
Close state: 10 Ω or less
Contact current: 3.3 mA or less
Voltage at open: Approx. 5 V DC

Capture judgment time: Approx. 250 ms

Function:

- Set value 1 (SV1) to Set value 4 (SV4) select
- Set value 1 (SV1) to Set value 2 (SV2) select + RUN/STOP transfer
- Set value 1 (SV1) to Set value 2 (SV2) select + AUTO/MAN transfer
- Set value 1 (SV1) to Set value 2 (SV2) select + Interlock release
- RUN/STOP transfer + AUTO/MAN transfer
- RUN/STOP transfer + Interlock release
- AUTO/MAN transfer + Interlock release



When the set value (SV) is set by digital input (DI), settings by communication and front keys are not available.



Prior to the RUN/STOP transfer and AUTO/MAN transfer by digital input (DI), the instrument must first be set to RUN mode and AUTO mode by communication or front keys.



Changes of state and mode by digital input (DI) are not stored in EEPROM.

■ Output

Number of output:	Up to 6 points (RB100: Up to 4 points)
Output type:	Relay contact output (1)
	Contact type: 1a contact
	Contact rating (Resistive load): 250 V AC 3 A, 30 V DC 1 A
	Electrical life: 100,000 times or more (Rated load)
	Mechanical life: 20 million times or more (Switching: 360 times/min [no-load])
	Relay contact output (2)
	Contact type: 1a contact
	Contact rating (Resistive load): 250 V AC 1 A, 30 V DC 0.5 A
	Electrical life: 150,000 times or more (Rated load)
	Mechanical life: 20 million times or more (Switching: 360 times/min [no-load])
	Voltage pulse output:
	Output voltage (Rating): 0/12 V DC
	ON voltage: 10 V to 13 V (at 20 mA)
	OFF voltage: 0.5 V or less
	Allowable load resistance: 600 Ω or more (20 mA or less) Not using OUT2: 40 mA or less
	Current output:
	Output current (Rating): 0 to 20 mA DC, 4 to 20 mA DC
	Output range: 0 to 21 mA DC, 1 to 21 mA DC
	Allowable load resistance: 500 Ω or less
	Output impedance: 1 M Ω or more
	Voltage output:
	Output voltage (Rating): 0 to 5 V DC, 1 to 5 V DC, 0 to 10 V DC
	Output range: -0.25 to +5.25 V DC, 0.8 to 5.2 V DC, -0.5 to +10.5 V DC
	Allowable load resistance: 1 k Ω or more
	Output impedance: 0.1 Ω or less
	Triac output:
	Output method: AC output (Zero-cross method)
	Allowable load current: 0.5 A (Ambient temperature 40 °C or less) Ambient temperature 50 °C: 0.3 A
	Load voltage: 75 to 250 V AC
	Minimum load current: 30 mA
	ON voltage: 1.6 V or less (at maximum load current)
	Open collector output:
	Output method: Sink type
	Allowable load current: 100 mA
	Load voltage: 30 V DC or less
	Minimum load current: 0.5 mA
	ON voltage: 2 V or less (at maximum load current)
	Leakage current at OFF: 0.1 mA or less

■ Performance (at the ambient temperature 23 ± 2 °C):

Input accuracy:

Measured input:

[For Fahrenheit: Converted value of Celsius]

Input type	Input range	Accuracy
K, J, T, E *1	Less than -100 °C	$\pm(2.0$ °C + 1 digit)
	-100 °C or more, Less than $+500$ °C	$\pm(1.0$ °C + 1 digit)
	500 °C or more	$\pm(0.2$ % of Reading + 1 digit)
N, R, S, PLII, W5Re/W26Re *2	Less than 0 °C	$\pm(4$ °C + 1 digit)
	0 °C or more, Less than 1000 °C	$\pm(2$ °C + 1 digit)
	1000 °C or more	$\pm(0.2$ % of Reading + 1 digit)
B *2	Less than 400 °C	$\pm(70$ °C + 1 digit)
	400 °C or more, Less than 1000 °C	$\pm(2$ °C + 1 digit)
	1000 °C or more	$\pm(0.2$ % of Reading + 1 digit)
Pt100, JPt100	Less than 200 °C	$\pm(0.4$ °C + 1 digit)
	200 °C or more	$\pm(0.2$ % of Reading + 1 digit)
Voltage input	$\pm(0.2$ % of span + 1 digit)	
Current input		

*1: Accuracy is not guaranteed for less than -100 °C

*2: Accuracy is not guaranteed for less than 400 °C for Input type R, S, B, and W5Re/W26Re.

Current transformer (CT) input:

± 5 % of Reading ± 1 digit or ± 2 A (whichever is larger)

Close horizontal mounting error:

Within ± 2.0 °C (Less than -100 °C input: ± 3.5 °C)

[RB500: Within ± 2.5 °C (Less than -100 °C input ± 4.0 °C)]

Output accuracy:

Current output: ± 5.0 % of span

Voltage output: ± 5.0 % of span

Transmission output (AO): ± 0.3 % of span

Influence ambient temperature (5 to 40 °C):

Input: TC/RTD inputs: ± 0.06 °C/°C

Voltage/Current inputs: ± 0.06 %/°C of span

Output: ± 0.02 %/°C of span

Influence of physical orientation ($\pm 90^\circ$ all orientations):

Input: TC input: ± 0.6 % of input span or ± 3.0 °C, or less

RTD input: ± 0.5 °C or less

Voltage/Current inputs: Less than ± 0.2 % of span

 Input error is added to the accuracy.

Output: Less than ± 0.3 % of span

 Input error is added to the accuracy.

■ Control

Control method:	PID control (Direct/Reverse action is selectable) Heat/Cool PID control P, PI, PD, or ON/OFF action is available
Additional function:	Autotuning, Startup tuning, Fine tuning

■ PID control

Overshoot suppression function: Anti-reset windup (ARW)

Setting range:

- a) Proportional band [heat-side] (P) *
 - TC/RTD inputs: 1 (0.1) to Input span (unit: °C [°F])
 - Voltage/Current inputs: 0.1 to 100.0 % of Input span
 - * 0 (0.0): ON/OFF action
 - ON/OFF action differential gap:
 - TC/RTD inputs: 0 (0.0) to 100 (100.0) °C [°F]
 - Voltage/Current inputs: 0.0 to 10.0 % of Input span
- b) Integral time (I): 1 to 3600 seconds (0: PD action)
- c) Derivative time (D): 1 to 3600 seconds (0: PI action)
- d) Anti-reset windup (ARW):
 - 1 to 100 % of Proportional band [heat-side]
 - (0: Integral action OFF)
- e) Derivative action: Measured value derivative,
Deviation derivative
- f) Proportional cycle time: 0 to 100 seconds
(0: Setting below 1 second is possible for
“Time setting of proportional cycle time [heat-side]”)
- g) Time setting of proportional cycle time [heat-side]:
0.1 seconds, 0.25 seconds, 0.5 seconds
- h) Output limiter (high/low):
 - −5.0 to +105.0 %
 - (High/Low individual setting) **
 - ** Output limiter low < Output limiter high
- i) Manual output: Output limiter low to Output limiter high

■ Heat/Cool PID control

Overshoot suppression function: Anti-reset windup (ARW)

Setting range:

- a) Proportional band [heat-side] (P) *
 - TC/RTD inputs: 1 (0.1) to Input span (unit: °C [°F])
 - Voltage/Current inputs: 0.1 to 100.0 % of Input span
 - * 0 (0.0): ON/OFF action
 - ON/OFF action differential gap:
 - TC/RTD inputs: 0 (0.0) to 100 (100.0) °C [°F]
 - Voltage/Current inputs: 0.0 to 10.0 % of Input span
- b) Integral time (I): 1 to 3600 seconds (0: PD action)
- c) Derivative time (D): 1 to 3600 seconds (0: PI action)
- d) Anti-reset windup (ARW):
 - 1 to 100 % of Proportional band [heat-side]
 - (0: Integral action OFF)
- e) Proportional band [cool-side] (Pc)
 - 1 to 1000 % of Proportional band [heat-side]
 - (Invalid when the Proportional band [heat-side] is “0”)
 - (ON/OFF control of cool-side only is not available)
- f) Overlap/Deadband:
 - TC/RTD inputs:
 - 10 (–10.0) to +10 (+10.0) °C [°F]
 - Voltage/Current inputs:
 - 10.0 to +10.0 % of Input span
 - (Minus (-) setting results in overlap.)
- g) Derivative action: Measured value derivative,
Deviation derivative
- h) Proportional cycle time [heat-side]:
 - 0 to 100 seconds
 - (0: Setting below 1 second is possible for
“Time setting of Proportional cycle time [heat-side]”)
- i) Proportional cycle time [cool-side]:
 - 0 to 100 seconds
 - (0: Setting below 1 second is possible for
“Time setting of proportional cycle time [cool-side]”)
- j) Time setting of proportional cycle time [heat-side]:
 - 0.1 seconds, 0.25 seconds, 0.5 seconds
- k) Time setting of proportional cycle time [cool-side]:
 - 0.1 seconds, 0.25 seconds, 0.5 seconds
- l) Output limiter high [heat-side]:
 - 0.0 to 105.0 %
- m) Output limiter low [cool-side]:
 - 0.0 to 105.0 %
- n) Cool action: Air cooling, water cooling, cooling gain linear
- o) Manual output: –Cool-side output limiter (high) to
+Heat-side output limiter (high)

■ Event function [optional]

Number of events:	Up to 4 points (Event function 1 to 4) Up to 2 points for RB100 Heat/Cool PID control. Up to 3 points for RB100 PID control with relay contact output on OUT2.
Output method:	Event 1: Digital output 1 (DO1) Event 2: Digital output 2 (DO2) Event 3: Output 2 (OUT2) [RB100] Digital output 3 (DO3) [RB400/500/700/900] Event 4: Digital output 4 (DO4) [RB400/500/700/900]
Event action:	Deviation high (Using SV monitor value) Deviation high with hold action (Using SV monitor value) Deviation high with re-hold action (Using SV monitor value) Deviation high (Using local SV) Deviation high with hold action (Using local SV) Deviation high with re-hold action (Using local SV) Deviation low (Using SV monitor value) Deviation low with hold action (Using SV monitor value) Deviation low with re-hold action (Using SV monitor value) Deviation low (Using local SV) Deviation low with hold action (Using local SV) Deviation low with re-hold action (Using local SV) Deviation high/low (Using SV monitor value) Deviation high/low with hold action (Using SV monitor value) Deviation high/low with re-hold action (Using SV monitor value) Deviation high/low (Using local SV) Deviation high/low with hold action (Using local SV) Deviation high/low with re-hold action (Using local SV) Deviation high/low (Using SV monitor value) [High/Low individual setting] Deviation high/low with hold action (Using SV monitor value) [High/Low individual setting] Deviation high/low with re-hold action (Using SV monitor value) [High/Low individual setting] Deviation high/low (Using local SV) [High/Low individual setting] Deviation high/low with hold action (Using local SV) [High/Low individual setting] Deviation high/low with re-hold action (Using local SV) [High/Low individual setting] Band (Using SV monitor value) Band (Using local SV) Band (Using SV monitor value) [High/Low individual setting] Band (Using local SV) [High/Low individual setting] Process high Process high with hold action Process low Process low with hold action

SV high (Using SV monitor value)
 SV high (Using local SV)
 SV low (Using SV monitor value)
 SV low (Using local SV)
 Control loop break alarm (LBA)
 FAIL
 Monitor during RUN
 Heater break alarm (HBA)
 Output of the communication monitoring result

Setting range:**Deviation action:**

- Event setting:
 - High/Low common setting: -Input span to +Input span
 Setting a minus (-) value for event types C, G, T (deviation high/low alarm) and D (band alarm) is taken as an absolute value.
- High/Low individual setting: -Input span to +Input span
- Differential gap: 0 to Input span

Process:

- Event setting: Same as input range
- Differential gap: 0 to Input span

SV:

- Event setting: Same as input range
- Differential gap: 0 to Input span

Control loop break alarm (LBA) time:

- LBA time: 0 to 7200 seconds
- LBA deadband (LBD): 0 to Input span

Heater break alarm (HBA):

- Number of HBA: Up to 2 points (1 point per CT input)
- Setting range: 0.0 to 100.0 A *
 * 0.0: HBA function OFF
 Current value monitoring is still available
- Number of HBA delay time: 0 to 255 times



CT does not detect current value when the event ON time or event OFF time is 0.5 seconds or less.

Output of the communication monitoring result:

Event signal is turned on when communication is not properly made for 10 seconds.



Event setting and Event differential gap are not available for the following actions:

Control loop break alarm (LBA), Heater break alarm (HBA), FAIL, Monitor during RUN, Output of the communication monitoring result

Additional function:	Hold action: OFF Hold action ON (When power turned on; when transferred from STOP to RUN) Re-hold action ON (When power turned on; when transferred from STOP to RUN; SV changed)
	 <ul style="list-style-type: none"> • During the operation of the Setting change rate limiter, Hold action and Re-hold action are not available. • Hold action is effective for Input value action or Deviation action. • Re-hold action is effective for Deviation action.
	Event timer: 0 to 600 seconds
	Interlock function: Use/Unuse is selectable
	Action at input burnout: Action is selectable

■ Transmission output (AO) [optional]

Number of outputs:	1 point (Transmission output must be specified for OUT2.)
Output contents:	Measured value (PV), Set value (SV), Manipulated output (MV1) [heat-side]
Output type:	Voltage output Output voltage (Rating): 0 to 5 V DC, 1 to 5 V DC, 0 to 10 V DC Output range: -0.25 to +5.25 V DC, 0.8 to 5.2 V DC, -0.5 to +10.5 V DC Allowable load resistance: 1 k Ω or more Output impedance: 0.1 Ω or less Current output Output current (Rating): 0 to 20 mA DC, 4 to 20 mA DC Output range: 0 to 21 mA DC, 1 to 21 mA DC Allowable load resistance: 500 Ω or less Output impedance: 1 M Ω or more
Output scaling:	High/Low individual setting Measured value (PV): Input scale low to Input scale high Set value (SV): Input scale low to Input scale high Manipulated output value (MV1) [heat-side]: -5.0 to +105.0 %

AO full scale adjustment value *:
-10.0 to +10.0 %

AO zero adjustment value *:
-10.0 to +10.0 %

* Do not change the factory set adjustment value for the AO full scale adjustment value and or the AO zero adjustment value as the accuracy will be changed.

■ SV selection function

Number of SV:	4 points
Setting method:	Front keys Communication Digital input (DI)
	 Attention must be paid to the number of EEPROM writes. (P. 10-18)
Setting range:	1 to 4

■ Timer function

Timer setting:	00 minutes 01 seconds to 99 minutes 59 seconds or 00 hours 01 minutes to 99 hours 59 minutes
Timer time unit:	Min.: sec. or Hour: min.
Function selection:	Timer function 1, Timer function 2, Timer function 3, Timer function 4
Repeat execution times:	0 to 9999 (9999: Infinite times) Effective when Timer function 3 or 4 is selected.



- When power failure occurs during the process of timer time, it restarts from 0:00.
- The timer time restarts from 0:00 when Timer functions are switched.

■ Operation mode

Auto mode:	Optimum PID values are automatically measured, computed and set.
Manual mode:	Optimum PID values are tuned manually by front keys.
Control stop (STOP mode):	Time-proportional control output: OFF (Contact open) *
	Control output (continuous): Low limit or less
	Transmission output (AO): OFF
	Event output: OFF (Contact open) *
	* Output still functions during in the Stop state

Output status at STOP mode:

Both event output and Transmission output (AO) are off.
Event output remains unchanged, and Transmission output (AO) is off.
Event output is off, and Transmission output (AO) remains unchanged.
Both Event output and Transmission output (AO) remain unchanged.

STOP display selection:	STOP on PV display + STOP lamp (green) lights.
	STOP on SV display + STOP lamp (green) lights.
	STOP lamp (green) lights.

■ Action at mode transfer

Transfer AUTO/MAN mode from Manual to Auto:

Automatically activates the Bumpless function when Measured value (PV) is within the Proportional band.

Bumpless function does not activate when Measured value (PV) is out of the Proportional band.



Bumpless function for Heat/Cool PID with Autotuning (AT) takes place as follows:

- When the Manual manipulated output value (MV) is positive number, Bumpless action takes place at the heat-side output.
- When the Manual manipulated output value (MV) is negative number, Bumpless action takes place at the cool-side output.

Transfer AUTO/MAN mode from Auto to Manual:

Set ON or OFF to Bumpless function

In case of “0: without bumpless”: Output the Manual manipulated value (MV)

In case of “1: with bumpless” Output the Manual manipulated value (MV) set before the AUTO/MAN transfer.



In Heat/Cool PID control with Autotuning (AT), Bumpless action is as follows:

- When Heat-side output value is set to the Manipulated value (MV) as positive output.
- When only cool-side output is output, Bumpless takes place at the negative output.
- When the output value is 0 % or less at both heat-side and cool-side, Manipulated value (MV) is also 0 % or less.

Transfer RUN/STOP mode from Stop to Run:

Same action as when the power is turned on.

■ Loader communication

Loader communication: For RKC communication protocol only

Synchronous method: Start/Stop synchronous type

Communication speed: 9600 bps

Data format:
Start bit: 1
Data bit: 8
Parity bit: Without
Stop bit: 1

Protocol: ANSI X3.28-1976 subcategories 2.5 and A4

Maximum connections: 1 point (Only COM-K2)
Address is fixed at 0.

Connection method: COM-K2 loader cable (equivalent to W-BV-01-1500)

Interval time: 10 ms

Other:

- ① The instrument can be powered from the COM-K2 (our USB communication converter) *
Control and host communication are suspended. For this reason, PV/SV display indicate “----“and the back light is partially turned off.
- ② While the instrument is powered by COM-K2 *, if power is applied to the instrument, the instrument will be reset and starts for normal operation.
- ③ When the instrument is normally powered, the host communication can be used simultaneously.

* COM-K (Version 1) is also available.

■ Communication [optional]

● RKC communication

Interface:	Based on RS-485, EIA standard
Connection method:	2-wire system, half-duplex multi-drop connection
Synchronous method:	Start/Stop synchronous type
Communication speed:	2400 bps, 4800 bps, 9600 bps, 19200 bps
Data bit configuration:	Start bit: 1 Data bit: 7 or 8 Parity bit: Without, Odd or Even Stop bit: 1 or 2
Protocol:	ANSI X3.28-1976 subcategories 2.5 and A4 RKC communication protocol Polling/Selecting type
Error control:	Vertical parity (With parity bit selected) Horizontal parity (BCC check)
Communication code:	JIS/ASCII 7-bit code
Termination resistor:	Externally terminal connected (Example: 120 Ω, 1/2 W)
Xon/Xoff control:	None
Maximum connections:	31 controllers
Signal logic:	RS-485

Signal voltage	Logic
$V(A) - V(B) \geq 2\text{ V}$	0 (SPACE)
$V(A) - V(B) \leq -2\text{ V}$	1 (MARK)

Voltage between V (A) and V (B) is the voltage of (A) terminal for the (B) terminal.

● Modbus

Interface:	Based on RS-485, EIA standard
Connection method:	2-wire system, half-duplex multi-drop connection
Synchronous method:	Start/Stop synchronous type
Communication speed:	2400 bps, 4800 bps, 9600 bps, 19200 bps
Data bit configuration:	Start bit: 1 Data bit: 8 Parity bit: Without, Odd or Even Stop bit: 1 or 2
Protocol:	Modbus
Signal transmission mode:	Remote Terminal Unit (RTU) mode
Function code:	03H (Read holding registers) 06H (Preset single register) 08H (Diagnostics: loopback test)
Error check method:	CRC-16
Error code:	1: Function code error 2: When the mismatched address is specified. 3: When the specified number of data items in the query message exceeds the maximum number of data items available 4: When the data written exceeds the setting range
Termination resistor:	Externally terminal connected (Example: 120 Ω , 1/2 W)
Maximum connections:	31 controllers

■ Self-diagnostic function

Control stop (Error number is displayed [Operation: Possible]):

Adjustment data error (Err 1)
 Data back-up error (Err 2)
 A/D conversion error (Err 4)
 Temperature compensation error (Err 4)

Action stop (Error number is not displayed [Operation: Impossible]):

Power supply voltage is abnormal
 Watchdog timer

■ Power

Power supply voltage: 100 to 240 V AC type:
 90 to 264 V AC [Including power supply voltage variation], 50/60 Hz,
 (Rating 100 to 240 V AC)
 Frequency variation: 50 Hz±10 %, 60 Hz±10 %
 24 V AC type:
 21.6 to 26.4 V AC [Including power supply voltage variation], 50/60 Hz,
 (Rating 24 V AC)
 Frequency variation: 50 Hz±10 %, 60 Hz±10 %
 24 V DC type:
 21.6 to 26.4 V DC [Including power supply voltage variation]
 (Rating 24 V DC)

Power consumption (at maximum load):

RB100:	5.5 VA max. (at 100 V AC) 8.5 VA max. (at 240 V AC) 4.7 VA max. (at 24 V AC) 108 mA max. (at 24 V DC)
RB400/500:	6.0 VA max. (at 100 V AC) 8.7 VA max. (at 240 V AC) 5.8 VA max. (at 24 V AC) 141 mA max. (at 24 V DC)
RB700:	6.0 VA max. (at 100 V AC) 8.7 VA max. (at 240 V AC) 5.8 VA max. (at 24 V AC) 147 mA max. (at 24 V DC)
RB900:	6.2 VA max. (at 100 V AC) 9.0 VA max. (at 240 V AC) 6.0 VA max. (at 24 V AC) 147 mA max. (at 24 V DC)

Rush current: 5.6 A or less (at 100 V AC)
 13.3 A or less (at 240 V AC)
 16.3 A or less (at 24 V AC)
 11.5 A or less (at 24 V DC)

Transportation and Storage environment conditions:

Vibration:

- Amplitude: < 7.5 mm (2 to 9 Hz)
 - Acceleration: < 20 m/s² (9 to 150 Hz)
- Each direction of XYZ axes

Shock: Height 400 mm or less

Temperature: -10 to +60 °C

Humidity: 10 to 90 %RH (Non condensing)

Mounting and Structure: Mounting method: Panel-mounted

Front panel material: PC [Flame retardancy: UL94 V-1]

Case material: PC [Flame retardancy: UL94 V-1]

Terminal block material: PPE [Flame retardancy: UL94 V-1]

Panel sheet material: Polyester

Weight:

RB100: Approx. 120 g

RB400: Approx. 185 g

RB500: Approx. 190 g

RB700: Approx. 200 g

RB900: Approx. 250 g

Dimensions:

RB100: 48 × 48 × 63 mm (W × H × D)

RB400: 48 × 96 × 60 mm (W × H × D)

RB500: 96 × 48 × 60 mm (W × H × D)

RB700: 72 × 72 × 60 mm (W × H × D)

RB900: 96 × 96 × 60 mm (W × H × D)

■ Standard**Safety standards:**

UL: UL61010-1

cUL: CAN/CSA-C22.2 No.61010-1

CE marking:

LVD: EN61010-1

OVERVOLTAGE CATEGORYII, POLLUTION DEGREE 2,
Class II (Reinforced insulation)

EMC: EN61326-1

RCM:

EN55011

Panel sealing:

NEMA 4X (NEMA 250), IP66 (IEC60529)

[Front panel (if specified in the model code)]

MEMO

APPENDIX

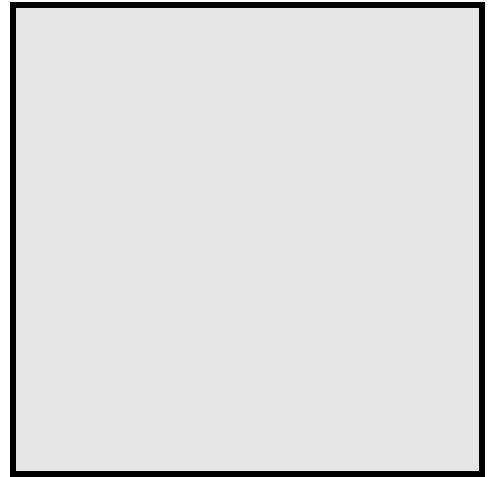

A. Removing the Internal Assembly.....	A-2
B. Replacing the Waterproof/Dustproof Rubber Gasket	A-4
C. Current Transformer (CT) Dimensions.....	A-6
D. 250 Ω Shunt Resistor for Current Input.....	A-7

A. Removing the Internal Assembly

Removing the internal assembly from the case is rarely required. Should you remove the internal assembly without disconnecting the external wiring, take the following steps:



WARNING

- To prevent electric shock or instrument failure, only qualified personnel should be allowed to pull out the internal assembly.
- To prevent electric shock or instrument failure, always turn off the power before pulling out the internal assembly.
- To prevent injury or instrument failure, do not touch the internal printed wiring board.



Apply pressure very carefully when removing internal assembly to avoid damage to the frame.



To conform to **IEC 61010-1** requirements for protection from electric shock, the internal assembly of this instrument can only be removed with an appropriate tool.

■ Procedures

1. Insert the screwdriver in the plug-in lock section as shown in the following figure, and then lightly push the screwdriver in the horizontal direction to release the plug-in lock released bar. The plug-in lock section is released.

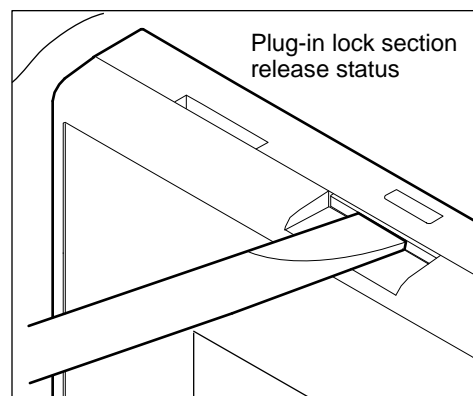
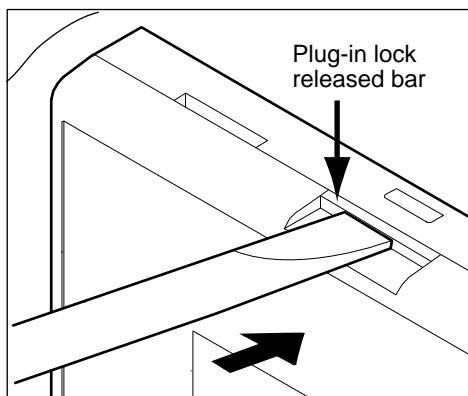
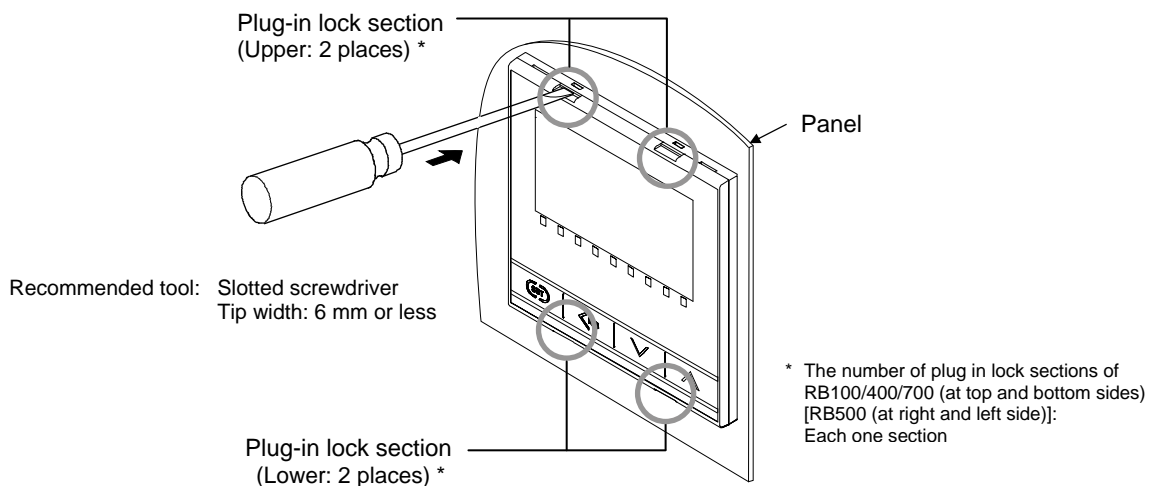

2. Insert the screwdriver in the case lock section as shown in the following figure, and then lightly turn the screwdriver to release the case lock section. The case lock section is released.

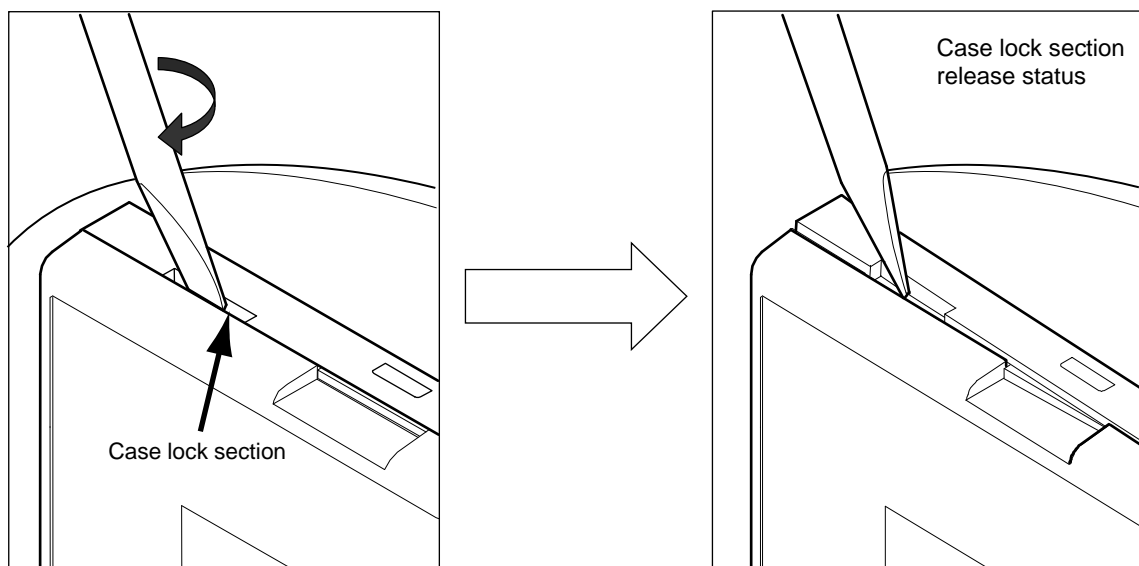
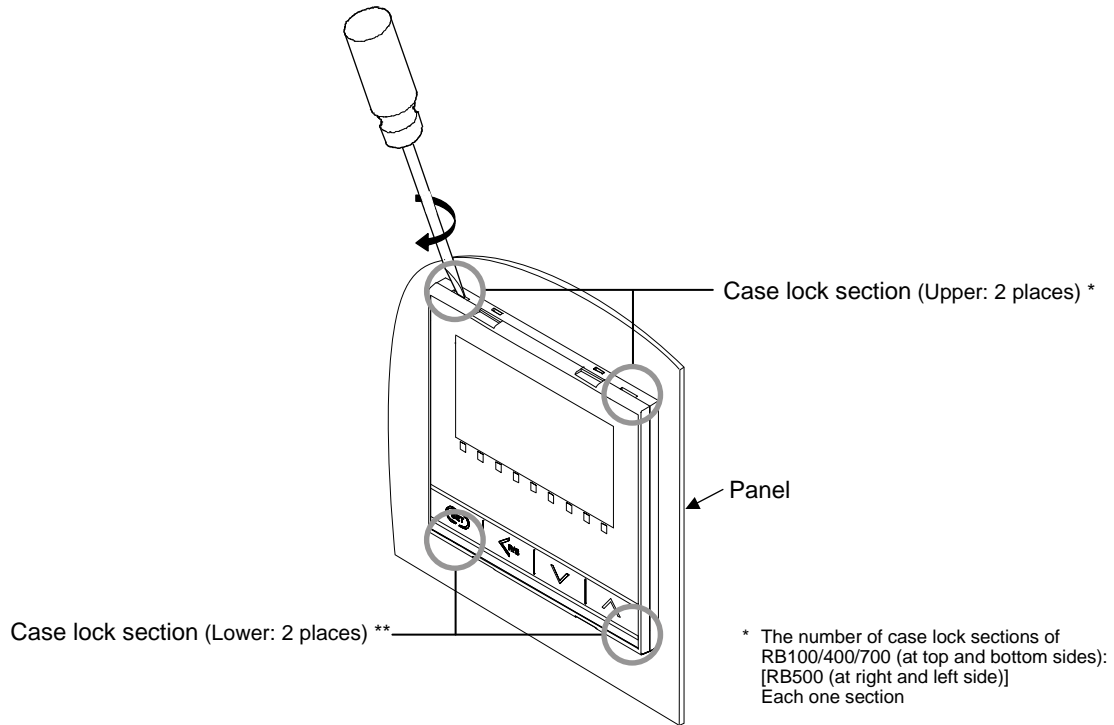

3. The other case lock section should be released the same way described in steps 1 and 2.
4. Remove the internal assembly from the case.

B. Replacing the Waterproof/Dustproof Rubber Gasket

If the waterproof and dustproof rubber gasket deteriorates, please contact RKC sales office or the agent. To replace the rubber gasket, take the following steps:

⚠ WARNING

- In order to prevent electric shock and instrument failure, always turn off the power supply before replacing the rubber gasket.
- In order to prevent electric shock and instrument failure, always turn off the power supply before pulling out the internal chassis.
- In order to prevent injury or instrument failure, do not touch the internal printed circuit board.

■ Replacement of the case rubber gasket

1. Turn the power OFF.
 2. Remove the wiring.
 3. Remove the mounting bracket, and then remove the instrument from the control panel.
- 👉 Refer to 2.3 Procedures of Mounting and Removing (P. 2-6).
4. Remove the old rubber gasket, and then replace the old rubber gasket with a new one.

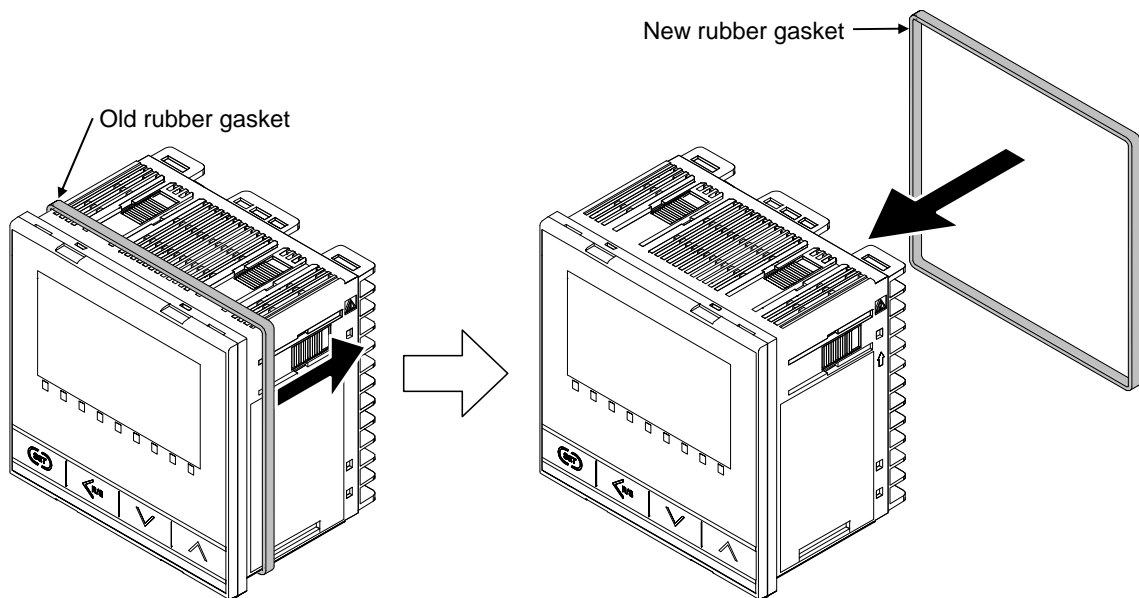

Parts list

	RB100	RB400/500	RB700	RB900
Parts code	KRB100-39	KFB400-36	KRB700-310	KFB900-36
Ordering code	00452425	00421214	00472960	00421248

■ Replacement of the board rubber gasket

1. Turn the power OFF.
2. Remove the internal assembly from the case.
 - ☞ Refer to **APPENDIX A. Removing the Internal Assembly (P. A-2)**.
3. Remove the old rubber gasket, and then replace the old rubber gasket with a new one.

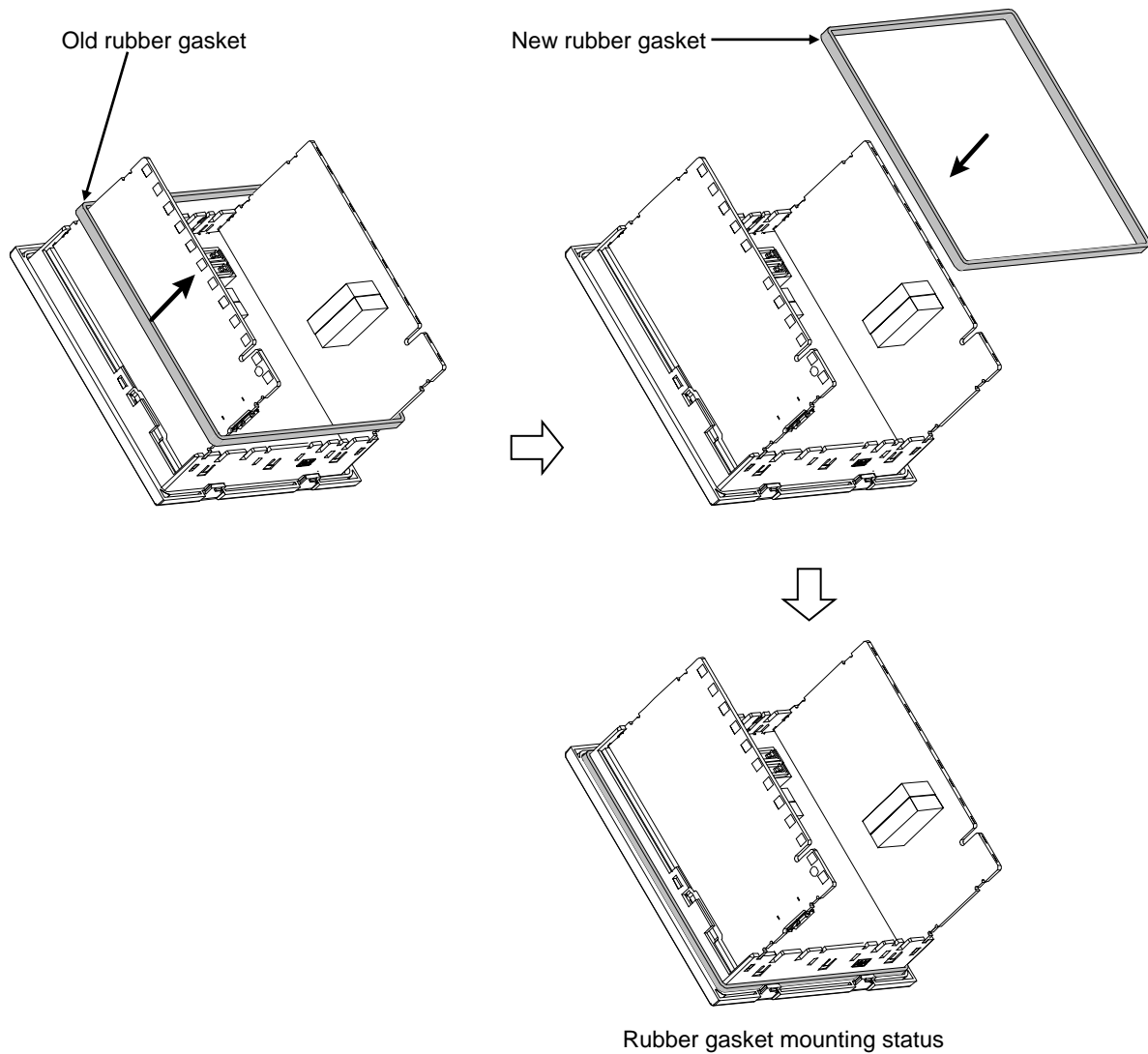

Parts list

	RB100	RB400/500	RB700	RB900
Parts code	KFB100-35	KRB400-39	KRB700-311	KRB900-39
Ordering code	00458663	00455130	00473562	00455148

4. Insert the internal assembly in the case.

C. Current Transformer (CT) Dimensions

■ CTL-6-P-N (For 0 to 30 A)

(Unit: mm)

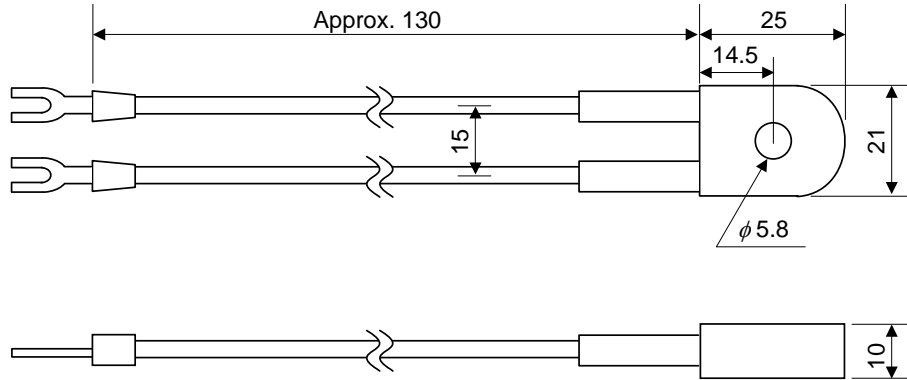

■ CTL-12-S56-10L-N (For 0 to 100 A)

(Unit: mm)

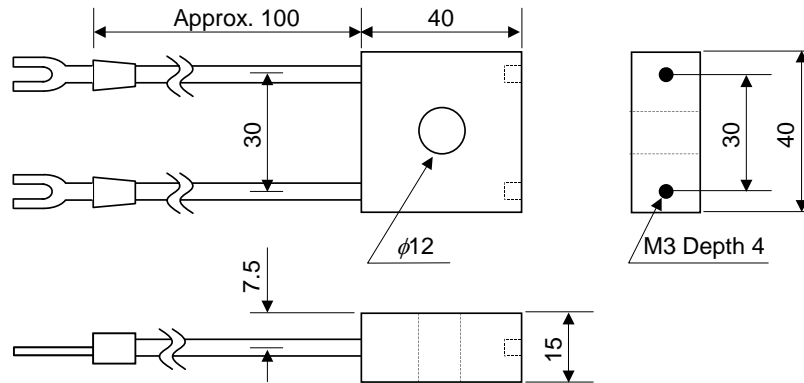

D. 250 Ω Shunt Resistor for Current Input

■ KD100-55

(Unit: mm)

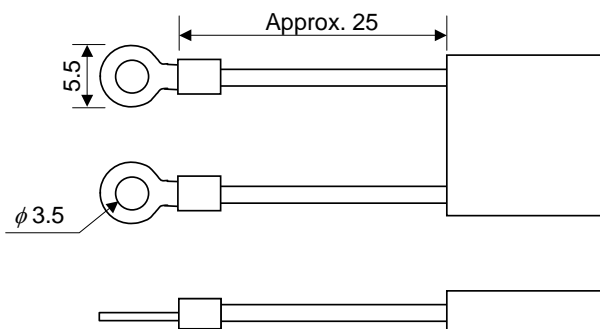

MEMO

Alphabetical order

A

Anti-reset windup (ARW)	8-27, 8-74
AO full scale adjustment value	8-100
AO zero adjustment value	8-100
AT cycles	8-130
AT differential gap time	8-131
Auto (AUTO)/Manual (MAN) transfer	6-20, 8-10
Autotuning (AT)	6-8, 8-24, 8-71

B

Bumpless mode setting	8-127
Burnout direction	8-90

C

Communication protocol	8-133
Communication response monitor	8-135
Communication speed	8-134
Control loop break alarm (LBA) time	8-32, 8-78
Control output at burnout	8-127
Cool action	8-125
CT ratio (Number of turns)	8-122
Current transformer 1 (CT1) input value monitor	8-4
Current transformer 2 (CT2) input value monitor	8-4

D

Data bit configuration	8-134
Decimal point position	8-90
Derivative action	8-128
Derivative time	8-27, 8-74
Device address	8-133
DI assignment	8-95
Direct/Reverse action	8-124

E

Energized/De-energized of Event 1 output	8-116
Energized/De-energized of Event 2 output	8-116
Energized/De-energized of Event 3 output	8-116
Energized/De-energized of Event 4 output	8-116
Event 1 timer	8-118
Event 1 differential gap	8-113
Event 1 hold action	8-110
Event 1 interlock	8-120
Event 1 output action at input burnout	8-115
Event 1 set value (EV1)	8-20, 8-68
Event 1 set value (EV1) [high]	8-20, 8-68
Event 1 set value (EV1') [low]	8-22, 8-69
Event 1 type	8-101
Event 2 timer	8-118
Event 2 differential gap	8-113

Event 2 hold action	8-110
Event 2 interlock	8-120
Event 2 output action at input burnout	8-115
Event 2 set value (EV2)	8-20, 8-68
Event 2 set value (EV2) [high]	8-20, 8-68
Event 2 set value (EV2') [low]	8-22, 8-69
Event 2 type	8-101
Event 3 timer	8-118
Event 3 differential gap	8-113
Event 3 hold action	8-110
Event 3 interlock	8-120
Event 3 output action at input burnout	8-115
Event 3 set value (EV3)	8-20, 8-68
Event 3 set value (EV3) [high]	8-20, 8-68
Event 3 set value (EV3') [low]	8-22, 8-69
Event 3 type	8-101
Event 4 timer	8-118
Event 4 differential gap	8-113
Event 4 hold action	8-110
Event 4 interlock	8-120
Event 4 output action at input burnout	8-115
Event 4 set value (EV4)	8-20, 8-68
Event 4 set value (EV4) [high]	8-20, 8-68
Event 4 set value (EV4') [low]	8-22, 8-69
Event 4 type	8-101

F

Fine tuning setting	6-17, 8-30, 8-75
---------------------------	------------------

H

Heater break alarm 1 (HBA1) set value	8-31, 8-77
Heater break alarm 2 (HBA2) set value	8-31, 8-77
Holding peak value ambient temperature monitor	8-137

I

Input scale high	8-91
Input scale low	8-91
Input type	8-88
Integral time	8-26, 8-73
Integrated operating time monitor	8-137
Interlock release	6-39, 8-11
Interval time	8-135

L

LBA deadband (LBD)	8-34, 8-78
--------------------------	------------

M

Manipulated output value (MV1) monitor [heat-side]	8-4
Manipulated output value (MV2) monitor [cool-side]	8-5

Manual manipulated output value (MV)..... 8-42, 8-86
 Measured value (PV)/Manipulated output value (MV) 8-8
 Measured value (PV)/Set value (SV) 8-7
 Measured value (PV)/Set value (SV) monitor 8-3
 Minimum ON/OFF time of proportioning cycle [cool-side]
 8-40, 8-82
 Minimum ON/OFF time of proportioning cycle [heat-side]
 8-37, 8-80
 Mode selection (no display) 6-35, 8-58
 Monitor selection (no display) 6-34, 8-58

N

Number of HBA delay times 8-123

O

ON/OFF action differential gap (lower) 8-126
 ON/OFF action differential gap (upper) 8-126
 Output limiter high [Heat-side output limiter (high)]
 8-38, 8-81
 Output limiter low [Cool-side output limiter (high)]
 8-38, 8-81
 Output action at STOP mode 8-96
 Overlap/Deadband 8-29, 8-75

P

Proportional band [cool-side] 8-28, 8-74
 Proportional band [heat-side] 8-26, 8-73
 Proportional cycle time [cool-side] 8-39, 8-81
 Proportional cycle time [heat-side] 8-36, 8-80
 PV bias 8-41, 8-84
 PV digital filter 8-41, 8-84
 PV flashing display at input error 8-94

R

Remaining time monitor 8-5
 Repeat execution times 7-10, 8-17, 8-64
 ROM version monitor 8-137
 RUN/STOP setting 8-59

S

Set data unlock/lock transfer 8-10
 Set lock level 6-24, 8-57
 Set value 1 (SV1) 8-13, 8-60
 Set value 2 (SV2) 8-13, 8-60
 Set value 3 (SV3) 8-13, 8-60
 Set value 4 (SV4) 8-13, 8-60
 Setting change rate limiter (down) 8-18, 8-66
 Setting change rate limiter (up) 8-18, 8-66
 Setting change rate limiter unit time 8-136
 Setting limiter high 8-93
 Setting limiter low 8-93

ST start condition 8-132
 Startup tuning (ST) 6-11, 8-25, 8-71
 STOP display selection 8-97
 SV selection 8-14, 8-61

T

Time setting of proportional cycle time [cool-side] 8-129
 Time setting of proportional cycle time [heat-side] 8-129
 Timer 1 7-5, 8-15, 8-63
 Timer 2 7-7, 8-15, 8-63
 Timer 3 7-9, 8-15, 8-63
 Timer 4 7-9, 8-15, 8-63
 Timer function 8-16, 8-64
 Timer time unit 8-136
 Transmission output scale high 8-99
 Transmission output scale low 8-99
 Transmission output type 8-98

Character Order

* Mode

MONI: Monitor display Mode MODE: Mode switching
 PARA: Parameter Setting mode ENG: Engineering mode

Symbol	Name	Mode *	Page
A (A)			
<i>Add</i>	Add Device Address	ENG (F60)	8-133
<i>AHS</i>	AHS Transmission output scale high	ENG (F33)	8-99
<i>ALS</i>	ALS Transmission output scale low	ENG (F33)	8-99
<i>Ao</i>	Ao Transmission output type	ENG (F33)	8-98
<i>AoFS</i>	AoFS AO full scale adjustment value	ENG (F33)	8-100
<i>AoZR</i>	AoZR AO zero adjustment value	ENG (F33)	8-100
<i>ARW</i>	ARW Anti-reset windup (ARW)	PARA, ENG (F06)	8-27, 8-74
<i>ATC</i>	ATC AT cycles	ENG (F52)	8-130
<i>ATH</i>	ATH AT differential gap time	ENG (F52)	8-131
<i>ATU</i>	ATU Autotuning (AT)	PARA, ENG (F05)	8-24, 8-71
<i>AUTO</i>	AUTO Auto (AUTO)/Manual (MAN) transfer [Auto (AUTO) mode]	MODE	8-10
B (b) (b)			
<i>bit</i>	bit Data bit configuration	ENG (F60)	8-134
<i>boS</i>	boS Burnout direction	ENG (F21)	8-90
<i>bPS</i>	bPS Communication speed	ENG (F60)	8-134
<i>bUMP</i>	bUMP Bumpless mode setting	ENG (F51)	8-127
C (C)			
<i>CMPS</i>	CMPS Communication protocol	ENG (F60)	8-133
<i>CMRM</i>	CMRM Communication response monitor	ENG (F60)	8-135
<i>CT1</i>	CT1 Current transformer 1 (CT1) input value monitor	MONI	8-4
<i>CT2</i>	CT2 Current transformer 2 (CT2) input value monitor	MONI	8-4
<i>CTR</i>	CTR CT ratio (Number of turns)	ENG (F45)	8-122
D (d) (d)			
<i>d</i>	d Derivative time	PARA, ENG (F06)	8-27, 8-74
<i>db</i>	db Overlap/Deadband	PARA, ENG (F06)	8-29, 8-75
<i>dF</i>	dF PV digital filter	PARA, ENG (F09)	8-41, 8-84
<i>dISL</i>	dISL DI assignment	ENG (F23)	8-95
<i>dSoP</i>	dSoP PV flashing display at input error	ENG (F21)	8-94
<i>dTP</i>	dTP Derivative action	ENG (F51)	8-128
E (E)			
<i>Ebo1</i>	Ebo1 Event 1 output action at input burnout	ENG (F41)	8-115
<i>Ebo2</i>	Ebo2 Event 2 output action at input burnout	ENG (F42)	8-115
<i>Ebo3</i>	Ebo3 Event 3 output action at input burnout	ENG (F43)	8-115
<i>Ebo4</i>	Ebo4 Event 4 output action at input burnout	ENG (F44)	8-115
<i>EH1</i>	EH1 Event 1 differential gap	ENG (F41)	8-113
<i>EH2</i>	EH2 Event 2 differential gap	ENG (F42)	8-113
<i>EH3</i>	EH3 Event 3 differential gap	ENG (F43)	8-113
<i>EH4</i>	EH4 Event 4 differential gap	ENG (F44)	8-113
<i>EHo1</i>	EHo1 Event 1 hold action	ENG (F41)	8-110
<i>EHo2</i>	EHo2 Event 2 hold action	ENG (F42)	8-110
<i>EHo3</i>	EHo3 Event 3 hold action	ENG (F43)	8-110
<i>EHo4</i>	EHo4 Event 4 hold action	ENG (F44)	8-110
<i>EIL1</i>	EIL1 Event 1 interlock	ENG (F41)	8-120
<i>EIL2</i>	EIL2 Event 2 interlock	ENG (F42)	8-120
<i>EIL3</i>	EIL3 Event 3 interlock	ENG (F43)	8-120
<i>EIL4</i>	EIL4 Event 4 interlock	ENG (F44)	8-120

Symbol	Name	Mode *	Page
<i>ES1</i>	ES1 Event 1 type	ENG (F41)	8-101
<i>ES2</i>	ES2 Event 2 type	ENG (F42)	8-101
<i>ES3</i>	ES3 Event 3 type	ENG (F43)	8-101
<i>ES4</i>	ES4 Event 4 type	ENG (F44)	8-101
<i>EV1</i>	EV1 Event 1 set value (EV1) Event 1 set value (EV1) [high]	PARA, ENG (F04)	8-20, 8-68
<i>EV1'</i>	EV1' Event 1 set value (EV1') [low]	PARA, ENG (F04)	8-22, 8-69
<i>EV2</i>	EV2 Event 2 set value (EV2) Event 2 set value (EV2) [high]	PARA, ENG (F04)	8-20, 8-68
<i>EV2'</i>	EV2' Event 2 set value (EV2') [low]	PARA, ENG (F04)	8-22, 8-69
<i>EV3</i>	EV3 Event 3 set value (EV3) Event 3 set value (EV3) [high]	PARA, ENG (F04)	8-20, 8-68
<i>EV3'</i>	EV3' Event 3 set value (EV3') [low]	PARA, ENG (F04)	8-22, 8-69
<i>EV4</i>	EV4 Event 4 set value (EV4) Event 4 set value (EV4) [high]	PARA, ENG (F04)	8-20, 8-68
<i>EV4'</i>	EV4' Event 4 set value (EV4') [low]	PARA, ENG (F04)	8-22, 8-69
<i>EVT1</i>	EVT1 Event 1 timer	ENG (F41)	8-118
<i>EVT2</i>	EVT2 Event 2 timer	ENG (F42)	8-118
<i>EVT3</i>	EVT3 Event 3 timer	ENG (F43)	8-118
<i>EVT4</i>	EVT4 Event 4 timer	ENG (F44)	8-118
<i>EXC1</i>	EXC1 Energized/De-energized of Event 1 output	ENG (F41)	8-116
<i>EXC2</i>	EXC2 Energized/De-energized of Event 2 output	ENG (F42)	8-116
<i>EXC3</i>	EXC3 Energized/De-energized of Event 3 output	ENG (F43)	8-116
<i>EXC4</i>	EXC4 Energized/De-energized of Event 4 output	ENG (F44)	8-116
H (H)			
<i>HbA1</i>	HbA1 Heater break alarm 1 (HBA1) set value	PARA, ENG (F07)	8-31, 8-77
<i>HbA2</i>	HbA2 Heater break alarm 2 (HBA2) set value	PARA, ENG (F07)	8-31, 8-77
<i>HbC</i>	HbC Number of HBA delay times	ENG (F45)	8-123
I (I)			
<i>I</i>	I Integral time	PARA, ENG (F06)	8-26, 8-73
<i>ILR</i>	ILR Interlock release	MODE	8-11
<i>INP</i>	INP Input type	ENG (F21)	8-88
<i>INT</i>	INT Interval time	ENG (F60)	8-135
L (L)			
<i>LbA</i>	LbA Control loop break alarm (LBA) time	PARA, ENG (F07)	8-32, 8-78
<i>Lbd</i>	Lbd LBA deadband (LBD)	PARA, ENG (F07)	8-34, 8-78
<i>LCK</i>	LCK Set data unlock/lock transfer [Lock]	MODE	8-10
<i>Lock</i>	Lock Set lock level	ENG (F00)	8-57
M (M)			
<i>MAN</i>	MAN Auto (AUTO)/Manual (MAN) transfer [Manual (MAN) mode]	MODE	8-10
<i>M-MV</i>	M-MV Manual manipulated output value (MV)	PARA, ENG (F10)	8-42, 8-86
<i>ModE</i>	ModE Mode selection (no display)	ENG (F00)	8-58
<i>MoNI</i>	MoNI Monitor selection (no display)	ENG (F00)	8-58
<i>MT</i>	MT Minimum ON/OFF time of proportioning cycle [heat-side]	PARA, ENG (F08)	8-37, 8-80
<i>Mt</i>	Mt Minimum ON/OFF time of proportioning cycle [cool-side]	PARA, ENG (F08)	8-40, 8-82
<i>MV</i>	MV Manipulated output value (MV1) monitor [heat-side]	MONI	8-4
<i>MV2</i>	MV2 Manipulated output value (MV2) monitor [cool-side]	MONI	8-5

Symbol	Name	Mode *	Page
O (o) (o)			
obo	Control output at burnout	ENG (F51)	8-127
oHH	ON/OFF action differential gap (upper)	ENG (F51)	8-126
oHL	ON/OFF action differential gap (lower)	ENG (F51)	8-126
oLH	Output limiter high [Heat-side output limiter (high)]	PARA, ENG (F08)	8-38, 8-81
oLL	Output limiter low [Cool-side output limiter (high)]	PARA, ENG (F08)	8-38, 8-81
oS	Direct/Reverse action	ENG (F51)	8-124
oS _c	Cool action	ENG (F51)	8-125
P (P)			
P	Proportional band [heat-side]	PARA, ENG (F06)	8-26, 8-73
P _b	PV bias	PARA, ENG (F09)	8-41, 8-84
P _c	Proportional band [cool-side]	PARA, ENG (F06)	8-28, 8-74
PGdP	Decimal point position	ENG (F21)	8-90
PGSH	Input scale high	ENG (F21)	8-91
PGSL	Input scale low	ENG (F21)	8-91
PTU	Fine tuning setting	PARA, ENG (F06)	8-30, 8-75
R (r) (r)			
R/S	RUN/STOP setting	ENG (F00)	8-59
RPTS	Repeat execution times	PARA, ENG (F02)	8-17, 8-64
S (S)			
SLH	Setting limiter high	ENG (F21)	8-93
SLL	Setting limiter low	ENG (F21)	8-93
SPCH	STOP display selection	ENG (F30)	8-97
SS	Output action at STOP mode	ENG (F30)	8-96
S-SV	SV selection	PARA, ENG (F01)	8-14, 8-61
STS	ST start condition	ENG (F52)	8-132
STU	Startup tuning (ST)	PARA, ENG (F05)	8-25, 8-71
SV1	Set value 1 (SV1)	PARA, ENG (F01)	8-13, 8-60
SV2	Set value 2 (SV2)	PARA, ENG (F01)	8-13, 8-60
SV3	Set value 3 (SV3)	PARA, ENG (F01)	8-13, 8-60
SV4	Set value 4 (SV4)	PARA, ENG (F01)	8-13, 8-60
SVRd	Setting change rate limiter (down)	PARA, ENG (F03)	8-18, 8-66
SVRf	Setting change rate limiter unit time	ENG (F70)	8-136
SVRU	Setting change rate limiter (up)	PARA, ENG (F03)	8-18, 8-66
SVT1	Timer 1	PARA, ENG (F02)	8-15, 8-63
SVT2	Timer 2	PARA, ENG (F02)	8-15, 8-63
SVT3	Timer 3	PARA, ENG (F02)	8-15, 8-63
SVT4	Timer 4	PARA, ENG (F02)	8-15, 8-63

Symbol	Name	Mode *	Page
T (t) (T, t)			
T	Proportional cycle time [heat-side]	PARA, ENG (F08)	8-36, 8-80
t	Proportional cycle time [cool-side]	PARA, ENG (F08)	8-39, 8-81
TCJ	Holding peak value ambient temperature monitor	ENG (F91)	8-137
TIME	Remaining time monitor	MONI	8-5
TMFS	Timer function	PARA, ENG (F02)	8-16, 8-64
TMU	Timer time unit	ENG (F70)	8-136
TU	Time setting of proportional cycle time [heat-side]	ENG (F51)	8-129
tU	Time setting of proportional cycle time [cool-side]	ENG (F51)	8-129
U (U)			
ULCK	Set data unlock/lock transfer [Unlock]	MODE	8-10
W (W)			
WT	Integrated operating time monitor	ENG (F91)	8-137



RKC INSTRUMENT INC.

HEADQUARTERS: 16-6, KUGAHARA 5-CHOME, OHTA-KU TOKYO 146-8515 JAPAN

PHONE: 03-3751-9799 (+81 3 3751 9799)

E-mail: info@rkcinst.co.jp

Website: <https://www.rkcinst.com/>

