

QUESTEMP[°]
HEAT STRESS MONITORS
MODELS 44 AND 46
USER MANUAL



Contents

Contents	iii
Introduction	1
QUESTemp° Models	1
Getting Started	2
Up and Running overview	2
Keypad Operation	2
Turning on/off and basic operation	3
Placing the QUESTemp° 44/46 on the job site	4
Sensors	5
About the sensor bar	5
Globe Thermometer	5
Waterless Wetbulb Sensor and Relative Humidity Sensor	5
Dry Bulb Thermometer	6
Remote, Sensors 2 and 3	7
Tri-sensor weighted average	7
Measurements	8
Waterless Wetbulb	8
WetBulb Globe Temperature	9
Stay Times/Rest Times (QT°46 only)	9
Heat Index/Humidex	9
Air Flow	9
Thermal Comfort	10
Operating QUESTemp° 44/46	11
View	11
Setup	11
Setup for Waterless Wetbulb measurement (air flow rate)	12
Print	12
Reset	13
Run	13
Displayed Items	14
Stay Time	15
Data Logging	16
Electronic sensor check	17
Performing an electronic sensor check	17
Sensor Alignment	18
RH Sensor Alignment	18
Printing	21
Serial	21
Parallel	22
Air Flow functionality	23
Operating sequence	24
Data Logging Air Flow	24
Batteries for Air Probe	24
Operational Check	24
Power options	25
9-Volt Alkaline Battery Replacement	25
Approved 9-Volt Batteries	25
NiMH Battery Pack	26
Appendix A: Specifications	27
Measurements	27
Data Logging	27
Languages	27
Housing	27
Size	27
Weight	27
Sensor Types	27
Accuracy	27
Operating Temperature Range	28
Remote Sensor Bars	28
Power Options	28
Battery Life	28
Charge Time (NiMH Battery Pack)	28
Air Probe Accessory	28
Appendix B: Heat Exposure Tables	29
ACGIH	29
ACGIH Clothing Corrections	30
United States Navy	30
Flag Conditions for U.S. Navy/Marine Corp. Ashore	32
Electrical power research institute (EPRI)	32
Appendix C: Accessories	33
Air Probe Accessories	33
Appendix D: TSI Detection Management Software DMS	34
QUESTemp° 44/46	34
Communication setup	34

Downloading data with the QT ^o 44/46	36
Viewing Data in DMS	37
Selecting a session/study.....	37
Charts and Graphs in Panel layout view (PLV) page	38
Reports and Printing.....	40

Contact/Service information.....	41
Technical Support Contacts.....	41
Service Contact Information.....	41
Returning for Service	42
Calibration	42
Warranty	43

List of Figures

1-1: QUESTemp ^o 44/46.....	1
1-2: Keypad explained Turning on/off and basic operation	3
1-3: Main menu of the QT ^o 44/46.....	3
1-4: About sensor bar and serial number	5
1-5: Sensors identified	6
1-6: Viewing measured data	11
1-7 Setting the air flow for Waterless Wetbulb sensor	12
1-8 Run mode indicator.....	13
1-9: Wet and Dry screen.....	14
1-10: Globe screen	14
1-11: WBGTi & WBGTo screen	14
1-12: RH and H.I/HU screen	14
1-13: Air Flow screen on QT ^o 46	14
1-14: Stay times (ACGIH)	14
1-15: Time & Date screen	15
1-16: Battery & Memory screen	15
1-17: Navy Stay time screen.....	15
1-18: Flag Conditions for U.S. Navy/Marine Corp. Ashore.....	16
1-19: EPRI Stay time screen.....	16

1-20: Main menu with view selected (A) & measurement screen (B)	18
1-21: Alignment screen.....	18
1-22: Sunshield & placement of finger cot prior to RH verification	19
1-23: RH alignment with Low % example	19
1-24: RH alignment with High% screen	20
1-25: DMS Report example	21
1-26: Report using parallel printer	22
1-27: Air flow configuration	23
1-28: 9-volt battery	25
1-29: NiMH rechargeable battery	26
1-30: Communicating with the QT ^o 44/46 and DMS.....	34
1-31: QT ^o 44/46 downloading data.....	35
1-32: Downloading QT ^o 44/46 files.....	36
1-33: Selecting a session.....	37
1-34: QT ^o 44/46 data in panel layout view	38
1-35: Rearranging panels and saving layout	39
1-36: Sample QT ^o 46 report	40

List of Tables

1-1: Example of a memory table.....	16
-------------------------------------	----

Introduction

The QUESTemp° 44 and QUESTemp° 46, offer traditional heat stress monitoring without the aggravation of maintaining a wet bulb. Through collaboration with Professor Dr. Thomas Bernard, from the College of Public Health at the University of South Florida, mathematical models were implemented to create a Waterless Wet Bulb calculation through a combination of dry bulb temperature, globe temperature, relative humidity, and air flow. The Waterless Wet Bulb is used to calculate the Wet Bulb Globe Temperature (WBGT) which is a widely-used method to monitor environmental conditions related to heat stress.



Figure 1-1: QUESTemp° 44/46 Heat Stress Monitor

QUESTemp° Models

QUESTemp° 44 and QUESTemp° 46 both measure and calculate the dry bulb, wet bulb, globe, WBGT indoors, WBGT outdoors, relative humidity, and Heat Index or Humidex.

With the QUESTemp° 46, you have the capability to measure stay times in order to manage work/rest regimens. Guidance is based on the screening criteria for heat stress as defined in the ACHIH TLV Handbook, U.S. Navy PHEL charts, U.S. Navy/Marine Corp. Ashore Flag system, and EPRI Action Limits.

An additional feature with the QUESTemp° 46 is an optional detachable probe for measuring air velocity to determine appropriate levels of indoor thermal comfort monitoring.

Getting Started

Up and Running Overview

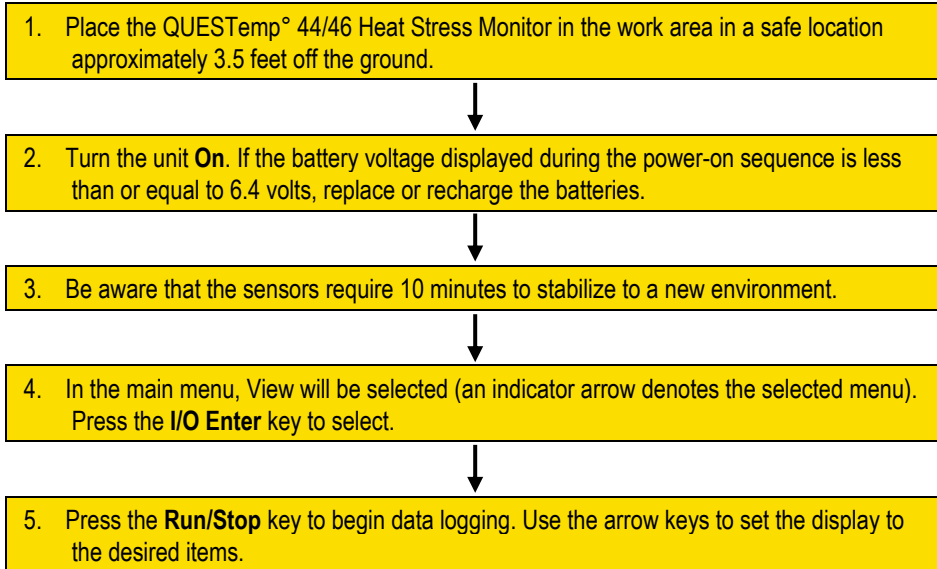

Keypad Operation

The unit operates using a keypad with four keys. The **I/O Enter key** responds when the key is released while all other keys respond when the key is pressed.

Keys	Explanation
I/O Enter key	The unit turns on with a single key press. The unit turns off by holding the key down while a countdown of 3-2-1 occurs in the lower right corner of the display. This key is also used to select a mode (such as Setup or View) or enter setup changes. Pressing and releasing the key while viewing temperatures causes the display to view the next available sensor bar (indicated in the upper right corner of the display).
Up Arrow key	Changes items appearing in the display. Scrolls up.
Down Arrow key	Changes items appearing in the display. Scrolls down.
Run/Stop key	From the menu or view modes, pressing this key starts or stops the run mode. Pressing this key will exit the setup, print or reset modes.

Keys	Explanation
Escaping or moving back one screen	If you are in the setup, print, reset, or calibration screens, you can press Run/Stop key to escape or move back one screen.



Figure 1-2: Keypad explained and identified

Turning On/Off and Basic Operation

To quickly get you started with the QUESTemp[®] 44/46, the following section explains how to turn on the instrument, run, and stop your session.

1. Press the **I/O Enter** key to **turn on**. Proceeding the model and revision information displayed on the screen, the main menu will appear.



Figure 1-3: Main menu of the QT[®]44/46

2. Press the **I/O Enter** key (when view is selected) to access the measurement screens.
 - (The Wet and Dry measurements screen will display. See Figure 1-6 for an example).

3. To view different measurements, press the **Up** or **Down arrow** key to toggle through the views.
 - ☑ **NOTE:** There are five user-selectable languages included in the QUESTemp° 44/46. If you see the fields such as Wet, Dry, WBGTi, and WBGT_o, this indicates the measurements are displaying in English.
 - To display an alternative language, select **Setup** from the main menu. Press the **Down** arrow repeatedly until "**English**" (or the appropriate language) appears. Then repeatedly press the **I/O enter** key to toggle through the languages. Once selected, all menus and measurement screens will change to the selected language. To return to the main menu, press the **Run/Stop** key.
4. To return to the **main menu**, press and hold the **I/O Enter** key (3, 2, 1 countdown will appear) and the main menu will display.
 - To select an option on the main menu, press the **up** or **down arrow** until an arrow appears directly in front of the appropriate menu selection and then press **I/O enter** key.
5. To **power off**, press and hold the **I/O enter key** from the main menu.

Placing the QUESTemp° 44/46 on the Job Site

The QUESTemp° 44/46 should be placed at a height of 3.5 feet (1.1 m) for standing individuals or 2 feet (.6 m) for seated individuals. Tripod mounting is recommended to get the unit away from anything that might block radiant heat or air flow. A 1/4" x 20 threaded bushing on the bottom of the instrument allows mounting to a standard photographic tripod. **DO NOT** stand close to the unit during sampling.

Before data logging, allow ten minutes for the sensors readings to stabilize.

Sensors

About the Sensor Bar

The sensor bar, on the QT^o 44/46, is calibrated to its specific instrument and is not interchangeable with other QT^o 44/46 products. The instrument has a sensor bar label which includes the serial number of the instrument and a sensor bar number. (This is indicated in the diagram below.)

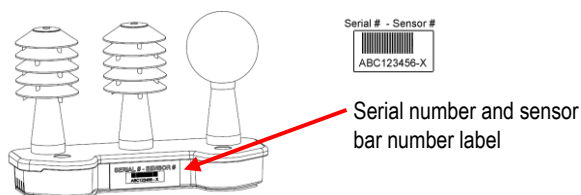

Figure 1-4: About sensor bar and serial number

Globe Thermometer

The globe thermometer (left position) gives an indication of the radiant heat exposure on an individual due to either direct sunlight or hot objects in the environment. This is accomplished by placing a temperature sensor inside a blackened copper sphere and measuring the temperature rise. The WBGT index is based on the response of a 6-inch diameter globe. The QUESTemp uses a 2-inch diameter globe for a faster response time. The temperature of the 2-inch globe is correlated to match that of a 6-inch globe.

Waterless Wetbulb Sensor and Relative Humidity Sensor

The relative humidity sensor (middle position) is used to calculate the Waterless Wetbulb from a combination of dry bulb temperature, humidity and wind speed measurements. The Waterless Wetbulb is used to calculate an estimated WBGT value.

Dry Bulb Thermometer

The dry bulb thermometer (right position) measures the ambient air temperature. This measurement is used in the outdoor WBGT calculation when a high solar radiant heat load may be present. The series of white plates surrounding the sensor shield it from radiant heat.



Figure 1-5: Sensors identified

Remote, Sensors 2 and 3

The top sensor bar (sensor 1) may be removed from the instrument and used through a remote cable. Shelter the instrument and remote the sensor bar if the measured environment is expecting heavy rain or if temperatures are above 60°C.

The sensor 2 and sensor 3 jacks on the side of the instrument allow simultaneous monitoring of up to three sensor arrays using connecting cables.

Cable lengths of up to two hundred feet (61 meters) may be used without a decrease in accuracy provided the environment does not contain strong electromagnetic fields.

The data from these arrays may be viewed separately or combined into a weighted average WBGT reading per ISO 7243. Change the displayed sensor bar by pressing and releasing the enter key. The upper right corner of the display shows the current sensor bar. 1 refers to the top sensor bar, 2 and 3 are labeled on the side of the unit, W indicates the weighted average which only appears if a WBGT is displayed and all three of the sensor bars are attached.

Tri-sensor Weighted Average

Per the recommendations outlined in ISO 7243:2017, when the temperature in the space surrounding a worker is not uniform, it is necessary to determine the WBGT index at three heights corresponding to the worker's ankles, abdomen and head and perform a weighted average on those values. It is computed using the formula:

$$\text{WBGT}_w = (\text{WBGT}_{\text{head}} + (2 \times \text{WBGT}_{\text{abdomen}}) + \text{WBGT}_{\text{ankles}}) / 4$$

The QUESTemp° 44/46 always assigns the top sensor bar the double weighting. This calculation is shown if a WBGT display has been selected and if three sensor sets are connected.

Measurements

The QUESTemp° 44/46 data logging area heat stress monitor directly senses three parameters: dry bulb temperature (DB), globe temperature (G), and relative humidity (RH).

It computes the wet bulb (WB), the Wet Bulb Globe Temperature (WBGT), stay times for four possible indices, and the Heat Index (HI) or the Canadian Humidex. Using inputs on the side of the instrument, two additional sensor arrays can monitor up to three locations simultaneously.

On the QUESTemp° 46 model, you can measure air flow, in meters per second, by plugging an optional hot wire anemometer sensor into a side jack on the unit.

Determine thermal comfort indices, Predicted Mean Vote (PMV) and Predicted Percent Dissatisfied (PPD), using Detection Management Software (DMS).

Waterless Wetbulb

The Waterless Wetbulb is an estimated measurement using the % of Relative Humidity, Dry Bulb Temperature, and Globe Bulb Temperature to determine the psychrometric wetbulb. The psychrometric wetbulb value is adjusted based on air flow to provide the waterless wetbulb estimate.

Computing Waterless Wetbulb and Wind Speed

When computing the waterless wetbulb, you can increase accuracy by setting the air flow to the current environments wind speed. The recommended air flow setting for an indoor environment is 0.3 m/s unless otherwise determined with an air-probe measurement (available only on the QT°46 model). The recommended setting for outdoor environment is 2.0 m/s.

NOTE: To convert wind speed from miles/hour to meters/sec use the following formula:

- **Miles/hour * .447 = meters/sec.** (Example: If the average wind speed is 5 mph, then enter $5 * .447 = 2.2$ meters/sec.)

If you are using the QUESTemp°46 with the Air Probe attached, you would not set the air flow setting. (It will automatically calculate with the current reading.)

See “Setup for Waterless Wetbulb measurement” for details on setting the Air flow.

WetBulb Globe Temperature

The WBGT is a weighted average of the three temperature sensors using the following formulas:

- $WBGT \text{ (indoor)} = 0.7WB + 0.3G$ (denoted as “WBGTi” on the display)
- $WBGT \text{ (outdoor)} = 0.7WB + 0.2G + 0.1DB$ (denoted as “WBGT_o” on the display)

The resulting WBGT values can then be compared to indices of work-rest regimens (stay times) based upon workloads.

Stay Times/Rest Times (QT^o46 only)

Stay times represent how long a worker should be able to safely work under heat stress conditions. Select one of four indices for displaying and printing from the unit: ACGIH Stay Times, NAVY PHEL's, U.S. Navy/Marine Corp. Ashore Flag Conditions, or EPRI Action Limits. Refer to [Appendix B](#) for more information on the indices.

Heat Index/Humidex

The Heat Index is determined using the dry bulb temperature and relative humidity. Based upon charts available from the U.S. National Weather Service, Heat Index represents how an average person feels relative to climate conditions. For a given temperature, the higher the humidity, the higher the heat index.

The Heat Index is defined over a temperature range of 70°F – 120°F (21°C – 49°C) and a relative humidity range of 30% – 99%. Outside of this range, the instrument will show dashes in the display for the Heat Index.

The Humidex, used primarily in Canada, works on the same concept as the Heat Index. The values are slightly different. The Humidex is defined over a temperature range of 70°F - 109°F (21°C - 43°C) and a relative humidity range of 20% - 99%. Outside of this range, the instrument will show dashes in the display for the Humidex.

Air Flow

The QUESTemp^o 46 measures air flow if TSI Quest's Air Probe accessory is used. The Air Probe uses an omni-directional anemometer sensor that measures air flow between 0 and 20 meters per second in 0.1m/s increments. See [“Air flow Functionality”](#) for more details.

Thermal Comfort

Thermal comfort readings for indoor environments are a benefit of Detection Management Software (DMS) and are not displayed or printed from the instrument directly. Readings are derived from the dry bulb, relative humidity, mean radiant temperature, air flow, and user entered parameters of clothing, metabolic rate and external work.

Thermal comfort indices, Predicted Mean Vote (PMV) and Predicted Percent Dissatisfied (PPD), help predict the thermal satisfaction level of a person with their indoor environment. The PMV is a rating scale of +3 to -3 where +3 is much too warm, -3 is much too cool, and 0 is thermally neutral. The PPD reflects what percent of people in a given location would be dissatisfied with their thermal surroundings.

The formulas used by DMS to derive the PMV and PPD come from the international standard ISO 7730 "Moderate thermal environments - Determination of the PMV and PPD indices and specification of the conditions for thermal comfort".

Operating QUESTemp° 44/46

Use the **Up Arrow** and **Down Arrow** keys to move the marker in the display in front of the desired mode. Pressing the **I/O Enter** key will select the mode.

View

Displays the measured data but does not log it. If more than one set of sensors is plugged into the unit, they can be displayed by pressing and releasing the **I/O ENTER** key. The displayed **sensor set** is shown in the **upper right corner**.



Figure 1-6: Viewing measured data

- ☑ **NOTE:** To return to the menu, hold down the **I/O ENTER** key while a 3, 2, 1 countdown is shown in the lower right corner of the display. Then the menu screen will appear (see Figure 1-3 for an example).

Setup

Allows changing temperature units, language, time, date, logging rate, selecting between Heat Index and Humidex, turning air flow on or off, and setting stay time parameters.

- To Setup parameters do one of the following:
1. From the main menu, select **Setup** by pressing the **I/O Enter** key.
 2. Use the **Arrow** keys to select an item (listed below).
 - **Temperature:** Celsius, Fahrenheit.
 - **Language:** English, Spanish, French, Italian, German.
 - **Time:** 24 hour clock only.
 - **Date:** Day-month-year format.
 - **Log Rate:** 1, 2, 5, 10, 15, 30, 60 minutes.
 - **Heat Index** (United States), **Humidex** (Canada)
 - **Flow:** On (QT°46 only), Off with fixed rate. (0.3 m/s is the recommended value for indoor applications and 2.0 m/s for outdoor applications)
 - **Index:** none, ACGIH, Navy, Marine, EPRI and select either: WBGTi (indoor), WBGT_o (outdoor) for Index setting.

Index Setting Notes

- **TLV and action limit** only apply to the ACGIH Index. EPRI Navy, and Marine will ignore this setting.
 - **Clothing Correction** parameters are set from 0 - 9.9°C. This is a clothing correction for the WBGT in degrees Celsius and is applied to the selected WBGT when the work duration is calculated. (It will not affect the WBGT as displayed by the unit.) This value should typically be set to 0.0 for the Navy. (The field is noted as "Clo Corr".)
3. Press the **I/O Enter** key to change a parameter. Time and date require using the **Up/Down Arrows** and **I/O Enter** keys to modify each number.
 - NOTE:** At any time, you can move back one level, by pressing the **Run/Stop** key.
 4. Exit Setup by pressing the **Run/Stop** key.

Setup for Waterless Wetbulb Measurement (air flow rate)

For the Waterless Wetbulb sensor calculation, an air flow rate (or wind speed) of 0.3 m/s is recommended and is the default setting of the instrument. **NOTE:** Only QT⁴⁶ supports the optional air-probe accessory.

If an air probe is not selected, the average wind speed of the environment should be configured. This value is then entered into the Flow screen under the setup menu.

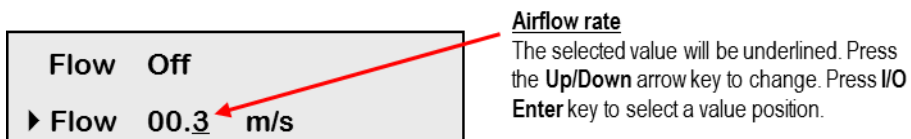

Figure 1-7: Setting the air flow for Waterless Wetbulb sensor

▶ To Setup Air flow rate

1. In the setup menu, select **Flow** by pressing the **Up/Down Arrow** key to select.
2. Press **I/O Enter** key and press **Up/Down Arrow** key to change the values. The **I/O Enter** key is pressed to toggle through the changeable fields and to return to the first column.

Print

Allows printing to a parallel or serial printer or to a computer. The QUESTemp[®] 44/46 will recognize the cable plugged in and configure itself for serial or parallel. If no cable is plugged in, it will default to serial. Press **I/O Enter** key to begin printing. Press **Run/Stop** key to return to the menu.

- NOTE:** If you want to stop the printing, press **I/O enter** key until you return to the main menu. When the printer has stopped printing, remove the cable from the printer to the instrument.

Reset

Resetting enables you to clear the logged data from memory. Press the **I/O Enter key** to enter the **Reset mode**. Clear the memory by holding down the **I/O Enter key** while the display counts down from three.

Run

The run mode begins a session in memory and logs the data.

1. Begin a session by pressing the **Run/Stop key** from the view mode (or measurement view). An asterisk in the lower right corner indicates the run mode.
 - To toggle through the views, press the up or down arrow.

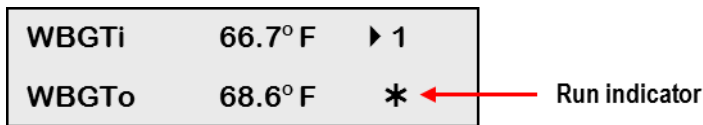

Figure 1-8: Run mode indicator

2. End the session by pressing the **Run/Stop key** again. (The session will stop recording when the asterisk is no longer displayed.)
 - NOTE:** If the logging memory is full or if there are no sensors plugged into the unit, attempting to enter the Run mode will result in an error message. If the memory capacity is exceeded, the asterisk in the lower right corner of the display will turn into an “F” and the memory remaining screen will show “0.0”.

Displayed Items

For the QUESTemp^o 44/46, the number in the upper right corner indicates which sensor bar's data is displayed.

- “1” indicates the sensor bar placed on (or attached to) the top of the instrument. Sensors 2 and 3 are labeled on the side of the unit as “Sensor 2”, and “Sensor 3”.
- “W” indicates the weighted average which only appears if a WBGT is displayed and all three sensor bars are attached. An asterisk in the lower right corner indicates that the unit is in the run mode and is logging data.

The following measurements can be accessed on the display:

Screen 1: WET (Wet bulb)
DRY (Dry bulb)

WET	80.5° F	▶ 1
DRY	92.2° F	*

Figure 1-9: Wet and Dry screen

Screen 2: GLOBE

GLOBE	92.4° F	▶ 1
		*

Figure 1-10: Globe screen

Screen 3: WBGTi (Indoors)
WBGT_o (Outdoors)

WBGTi	84.1° F	▶ 1
WBGT_o	107.5° F	*

Figure 1-11: WBGTi & WBGT_o screen

Screen 4: RH (Relative Humidity)
H.I. or HU
(Heat Index or Humidex)

RH	66.2 %	▶ 1
H.I.	84.3° F	*

Figure 1-12: RH and H.I./HU screen

Screen 5: Air Flow (QT^o46 only)
(If turned ON via setup)

FLOW	0.3m/s	▶ 1
-------------	---------------	------------

Figure 1-13: Air Flow screen on QT^o46

Screen 6: Stay times (QT^o46 only)

L	M	H	VH	▶ 1
60	45	30	15	*

Figure 1-14: Stay times (ACGIH)

Screen 7: Time (24 hour format)
Date (day, month, year)

TIME	11:04:13	▶ 1
DATE	26-JUN-08	*

Figure 1-15: Time & Date screen

Screen 8: BAT (Battery voltage)
MEM (Logging memory available in days)

BAT	11:04:13	▶ 1
MEM	10.4dy	*

Figure 1-16: Battery & Memory screen

NOTE: A series of dashes appear in the display if one of the following occur:

- The Heat Index or Humidex is outside of its allowable range
- The temperature is outside of its allowable range
- A temperature sensor has failed
- Stay times temperatures are outside of the their defined range

Stay Time

The screen(s) displaying stay time data appear different for each of the possible indices.

If **ACGIH** is selected, the recommended working minutes per hour are shown for each of the workload categories Light (L), Moderate (M), Heavy (H), and Very Heavy (VH). (See Figure 1-13 above.)

If the **Navy PHELs** are selected, the recommended working hours are shown based on a maximum of eight hours. Three screens are used to display the PHELs two at a time.

NOTE: "8:01" following one of the PHELs indicates greater than eight hours.

PHEL_5	3:10	▶ 1
PHEL_6	2:10	

Figure 1-17: Navy Stay time screen

If **Flag** is selected, the Flag Conditions for U.S. Navy/Marines Corp. Ashore warning system screen will appear. There are five flag systems, no flag, yellow, green, red, and black, which provide heat exposure guidelines for acclimated individuals. (For more information, refer to the “U.S. Navy/ Marine Corp. Ashore Flag System”.)

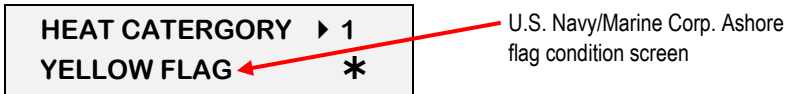

Figure 1-18: Flag Conditions for U.S. Navy/Marine Corp. Ashore

If **EPRI** is selected, the recommended working hours are shown based on a maximum of four hours. Working hours for Light (L), Moderate (M), and Heavy (H) workload categories are displayed below.

NOTE: “4:01” indicates greater than four hours.

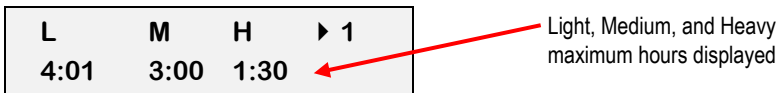

Figure 1-19: EPRI Stay time screen

Data Logging

Data from each sensor is recorded at the interval set by the logging rate. Every time **Run/Stop** is pressed, a session is either started or ended in memory. Each session contains a header with time, date, and summary information.

Memory Table: Gives the number of logging DAYS.

Log Rate	1 min	2 min	5 min	10 min	15 min	30 min	60 min
1 sensor	11.2	22.5	56.2	112.4	168.6	337.3	674.5
2 sensors	5.6	11.2	28.1	56.2	84.3	168.6	337.3
3 sensors	3.7	7.5	18.7	37.5	56.2	112.4	224.8

Table 1-1: Data logging (or memory table) table example

Electronic Sensor Check

A verification module, Quest model 053-923, may be used to check the operation of the QUESTemp's wet bulb, dry bulb, and globe. The purpose is to verify that the electronic components are within a specific range with known values and a known source. The temperature tolerances should be within $\pm 0.5^{\circ}\text{C}$.



Example of Verification module

- **NOTE:** If the sensors are outside of the tolerances, this indicates the sensor alignment should be serviced off-site for calibration.

Performing an Electronic Sensor Check

1. Ensure the instrument is reading in Celsius prior to your electronic sensor check.
 - To change the temperature setting, select Setup from the main menu. Then, either Fahrenheit or Celsius will appear on the screen. When selected, press **I/O enter** key to switch between settings. For more information, refer to Operating.
2. Remove the top sensor bar, place to the side, and plug in the verification module into the center pins of the sensor housing.
3. Verify the measurement readings on the screen are within $\pm 0.5^{\circ}\text{C}$ tolerance to the readings printed on the verification module label. Example below:
 - a. Wet Bulb (WB) – 11.1°C
 - b. Dry Bulb (DB) - 45.3°C
 - c. Globe (G) – 69.2°C
 - **NOTE:** Relative humidity (RH) is not valid on this instrument.
4. Once completed, remove verification module and place sensor bar back on the instrument. (Tighten down the two bolts.) Change the Celsius reading back to Fahrenheit. (Refer to step 1 a-b.)

Sensor Alignment

For highly accurate measurement readings, you should align your QUESTemp[®] 44/46 prior to data logging. For the RH sensor, it is recommended to align with a High concentration level using the 75% sensor salt, NaCl (sodium chloride), or a Low concentration level using the, the 33% sensor salt, MgCl (magnesium chloride). (See ColePalmer.com to order sensor alignment salts.)

RH Sensor Alignment

1. To open, navigate to the main menu and select **View** by pressing **I/O Enter** key (see **A**). A measurement screen will appear (see **B**).

(A)	▶ VIEW	PRINT	(B)	WET	50.7° F
	SETUP	RESET		DRY	70.6° F

Figure 1-20: Main menu with view selected (A) & measurement screen (B)

2. Press and hold **I/O Enter** key and then press **Down Arrow** key from the **View** menu. The Alignment screen will appear.

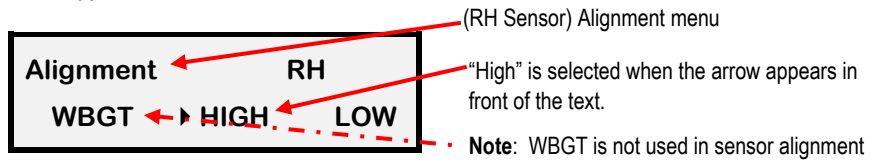

Figure 1-21: Alignment screen

3. Press **Up/Down Arrow** key to select either **High** or **Low**. Then press **I/O Enter** key.
4. **Remove** (or slide) the **Sunshield** (white globe) from the **RH sensor** and place it to the side. (See Figure 1-22.)

5. Place a latex finger cot (user supplied) over the humidity sensor in order for the sensor to stabilize quicker about 15 minutes (or up to 60 minutes without). **NOTE:** Latex finger cots can be found at various hardware stores or online such as ColePalmer.com.



Figure 1-22: Sunshield & placement of finger cot prior to RH verification

6. Place the **Salt container**, with the salt alignment cap removed, over the **RH sensor** (middle sensor). Allow level to **stabilize** for at least **15 minutes**. (Refer to Figure 1-23.)
- About sensor alignment: if readings are within $\pm 0.5\%$, a change in sensor alignment is not required. Skip to step 7 to return to main menu.
- NOTE:** For a High alignment, use the 75% sensor alignment salt (NaCl) and for a Low alignment, use the 33% alignment salt (MgCl).

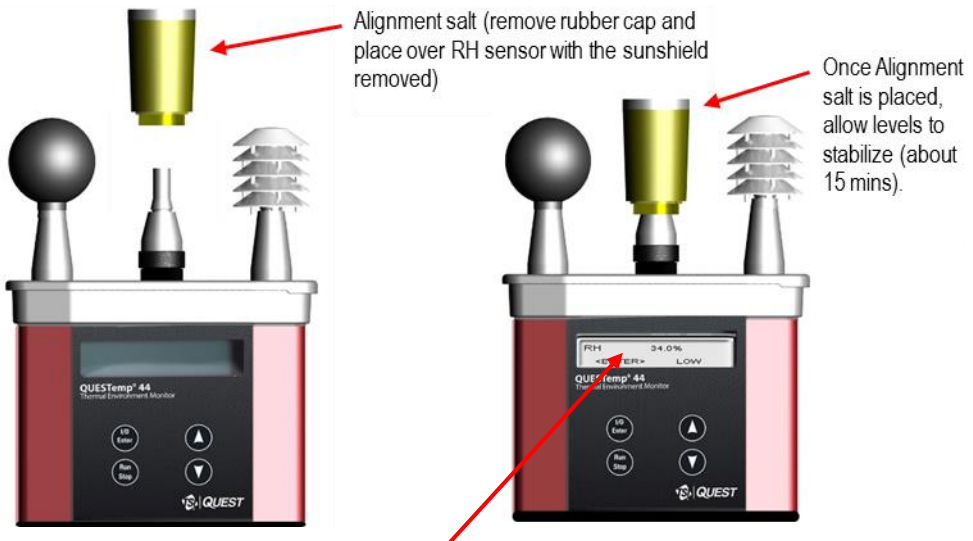

Low RH Alignment screen

Adjust % to 33% (using up/down arrow keys) and press Enter (after level has stabilized) to store sensor alignment level.

Figure 1-23: RH alignment with Low % example

- In either the High/Low RH alignment screen, adjust the level to the percentage displayed on the salt container by using the **Up/Down Arrow** keys. Press **I/O Enter** key to save. (The instrument will state either “Successful” or “Failure” if it passed/did not pass. For “Failure” repeat the steps above.)

Press **Enter**
to save the
alignment.



Example of high RH percentage prior to
sensor alignment. Press up/down arrows to
adjust level after salt has stabilized.

Sensor alignment with High % RH level.

Figure 1-24: RH alignment with High% screen

- To return to the main menu, press **Run/Stop** key.
- Verify the RH sensor is $\pm 0.5\%$ of the specific percentage. If not repeat the steps above.
- Remove the alignment salt and finger cot. Replace the Sunshield over the RH sensor when completed with the sensor alignment.

Printing

The recorded data can be sent to a computer through the serial RS232 port or to a parallel printer. Serial transmission requires cable #054-715. Parallel transmission requires cable #056-875. With the cable plugged in, select **PRINT** from the menu and press the **I/O Enter key** to enter the **PRINT** mode. Begin printing by pressing the **I/O Enter key**. Press the key again to abort printing.

Serial

TSI Detection Management Software (DMS) is recommended for downloading, storing, and graphing your data. Communications programs such as Windows® HyperTerminal® program may also be used to capture the printout into a file. The baud rate is fixed at 9600.



Figure 1-25: DMS Report example

Parallel

Data can be sent directly to parallel printers that accept direct ASCII test input without special drivers. Make sure the **printer is powered on** and is **online**, ready to accept data, prior to printing.

<p style="text-align: center;">QUEST TECHNOLOGIES, TSI Page 1 HEAT STRESS REPORT</p> <p>File Name _____ QUESTemp^o46 Rev 1.00 Serial # TK09090909</p> <p>Employee _____</p> <p>Facility _____ Session (3) Start: 21-NOV-09 11:07:32</p> <p>Department _____ Stop: 21-NOV-09 11:10:15</p> <p>Job _____ Printed: 21-NOV-09 11:16:00</p> <p>Comments/Notes _____</p> <hr/> <p>Logging Interval: 1 minutes Degrees Fahrenheit</p> <p>MAXIMUM LEVELS, Sensor 1</p> <table style="width: 100%; border-collapse: collapse;"> <tr><td>WBGT</td><td>68.3</td><td>21-NOV-09</td><td>11:10:08</td></tr> <tr><td>DRY BULB</td><td>82.7</td><td>21-NOV-09</td><td>11:09:56</td></tr> <tr><td>GLOBE</td><td>91.4</td><td>21-NOV-09</td><td>11:10:12</td></tr> <tr><td>REL HUMIDITY</td><td>14%</td><td>21-FEB-08</td><td>11:07:32</td></tr> <tr><td>FLOW (m/s)</td><td>0.6</td><td>21-FEB-08</td><td>11:09:08</td></tr> </table> <p>MAXIMUM LEVELS, Sensor 2</p> <table style="width: 100%; border-collapse: collapse;"> <tr><td>WBGT</td><td>80.5</td><td>21-FEB-08</td><td>11:10:11</td></tr> <tr><td>DRY BULB</td><td>99.2</td><td>21-FEB-08</td><td>11:09:07</td></tr> <tr><td>GLOBE</td><td>106.1</td><td>21-FEB-08</td><td>11:10:06</td></tr> <tr><td>HEAT INDEX</td><td>0</td><td>00-XXX-00</td><td>00:00:00</td></tr> <tr><td>REL HUMIDITY</td><td>15%</td><td>21-FEB-08</td><td>11:07:32</td></tr> </table> <p>MAXIMUM LEVELS, Sensor 3</p> <table style="width: 100%; border-collapse: collapse;"> <tr><td>WBGT</td><td>68.6</td><td>21-FEB-08</td><td>11:09:56</td></tr> <tr><td>DRY BULB</td><td>88.6</td><td>21-FEB-08</td><td>11:10:08</td></tr> <tr><td>GLOBE</td><td>93.0</td><td>21-FEB-08</td><td>11:10:03</td></tr> <tr><td>HEAT INDEX</td><td>0</td><td>00-XXX-00</td><td>00:00:00</td></tr> <tr><td>REL HUMIDITY</td><td>11%</td><td>21-FEB-08</td><td>11:07:32</td></tr> </table> <p>MAXIMUM LEVELS, Sensor(WEIGHTED AVERAGE)</p> <table style="width: 100%; border-collapse: collapse;"> <tr><td>WBGT</td><td>71.4</td><td>21-FEB-08</td><td>11:10:14</td></tr> </table>	WBGT	68.3	21-NOV-09	11:10:08	DRY BULB	82.7	21-NOV-09	11:09:56	GLOBE	91.4	21-NOV-09	11:10:12	REL HUMIDITY	14%	21-FEB-08	11:07:32	FLOW (m/s)	0.6	21-FEB-08	11:09:08	WBGT	80.5	21-FEB-08	11:10:11	DRY BULB	99.2	21-FEB-08	11:09:07	GLOBE	106.1	21-FEB-08	11:10:06	HEAT INDEX	0	00-XXX-00	00:00:00	REL HUMIDITY	15%	21-FEB-08	11:07:32	WBGT	68.6	21-FEB-08	11:09:56	DRY BULB	88.6	21-FEB-08	11:10:08	GLOBE	93.0	21-FEB-08	11:10:03	HEAT INDEX	0	00-XXX-00	00:00:00	REL HUMIDITY	11%	21-FEB-08	11:07:32	WBGT	71.4	21-FEB-08	11:10:14	<p>SESSION: 1 Page 2 Sensor: 1 Degrees Fahrenheit Stay Times: ACGIH, Acclimated, WBGT, clo correction = 1.0 °C</p> <table style="width: 100%; border-collapse: collapse;"> <thead> <tr><th>TIME</th><th>WBGT</th><th>DRY</th><th>GLOBE</th><th>RH</th><th>HI</th><th>FLOW</th><th>L</th><th>M</th><th>H</th><th>VH</th></tr> </thead> <tbody> <tr><td>11:08</td><td>67.9</td><td>82.4</td><td>90.7</td><td>13</td><td>0</td><td>0.5</td><td>60</td><td>60</td><td>60</td><td>60</td></tr> <tr><td>11:09</td><td>68.1</td><td>82.6</td><td>91.3</td><td>12</td><td>0</td><td>0.5</td><td>60</td><td>60</td><td>60</td><td>60</td></tr> </tbody> </table> <p>SESSION: 1 Page 3 Sensor: 2 Degrees Fahrenheit Stay Times: ACGIH, Acclimated, WBGT, clo correction = 1.0 °C</p> <table style="width: 100%; border-collapse: collapse;"> <thead> <tr><th>TIME</th><th>WBGT</th><th>DRY</th><th>GLOBE</th><th>RH</th><th>HI</th><th>L</th><th>M</th><th>H</th><th>VH</th></tr> </thead> <tbody> <tr><td>11:08</td><td>79.3</td><td>98.9</td><td>104.5</td><td>15</td><td>0</td><td>60</td><td>45</td><td>30</td><td>15</td></tr> <tr><td>11:09</td><td>80.2</td><td>99.2</td><td>105.6</td><td>15</td><td>0</td><td>60</td><td>45</td><td>30</td><td>15</td></tr> </tbody> </table> <p>SESSION: 1 Page 4 Sensor: 3 Degrees Fahrenheit Stay Times: ACGIH, Acclimated, WBGT, clo correction = 1.0 °C</p> <table style="width: 100%; border-collapse: collapse;"> <thead> <tr><th>TIME</th><th>WBGT</th><th>DRY</th><th>GLOBE</th><th>RH</th><th>HI</th><th>L</th><th>M</th><th>H</th><th>VH</th></tr> </thead> <tbody> <tr><td>11:08</td><td>68.1</td><td>88.0</td><td>92.7</td><td>11</td><td>0</td><td>60</td><td>60</td><td>60</td><td>60</td></tr> <tr><td>11:09</td><td>68.4</td><td>88.3</td><td>92.9</td><td>11</td><td>0</td><td>60</td><td>60</td><td>60</td><td>60</td></tr> </tbody> </table> <p>SESSION: 2 Page 5 Sensor: WBGT(W-AVG) = .50*WBGT(1) + .25*WBGT(2) + .25*WBGT(3) Degrees Fahrenheit</p> <p>Stay Times: ACGIH, Acclimated, WBGT, clo correction = 1.0 C WBGT WBGT_o</p> <table style="width: 100%; border-collapse: collapse;"> <thead> <tr><th>TIME</th><th>W-AVG</th><th>W-AVG</th><th>L</th><th>M</th><th>H</th><th>VH</th></tr> </thead> <tbody> <tr><td>11:08</td><td>71.5</td><td>70.8</td><td>60</td><td>60</td><td>60</td><td>60</td></tr> <tr><td>11:09</td><td>71.8</td><td>71.1</td><td>60</td><td>60</td><td>60</td><td>45</td></tr> </tbody> </table>	TIME	WBGT	DRY	GLOBE	RH	HI	FLOW	L	M	H	VH	11:08	67.9	82.4	90.7	13	0	0.5	60	60	60	60	11:09	68.1	82.6	91.3	12	0	0.5	60	60	60	60	TIME	WBGT	DRY	GLOBE	RH	HI	L	M	H	VH	11:08	79.3	98.9	104.5	15	0	60	45	30	15	11:09	80.2	99.2	105.6	15	0	60	45	30	15	TIME	WBGT	DRY	GLOBE	RH	HI	L	M	H	VH	11:08	68.1	88.0	92.7	11	0	60	60	60	60	11:09	68.4	88.3	92.9	11	0	60	60	60	60	TIME	W-AVG	W-AVG	L	M	H	VH	11:08	71.5	70.8	60	60	60	60	11:09	71.8	71.1	60	60	60	45
WBGT	68.3	21-NOV-09	11:10:08																																																																																																																																																																																
DRY BULB	82.7	21-NOV-09	11:09:56																																																																																																																																																																																
GLOBE	91.4	21-NOV-09	11:10:12																																																																																																																																																																																
REL HUMIDITY	14%	21-FEB-08	11:07:32																																																																																																																																																																																
FLOW (m/s)	0.6	21-FEB-08	11:09:08																																																																																																																																																																																
WBGT	80.5	21-FEB-08	11:10:11																																																																																																																																																																																
DRY BULB	99.2	21-FEB-08	11:09:07																																																																																																																																																																																
GLOBE	106.1	21-FEB-08	11:10:06																																																																																																																																																																																
HEAT INDEX	0	00-XXX-00	00:00:00																																																																																																																																																																																
REL HUMIDITY	15%	21-FEB-08	11:07:32																																																																																																																																																																																
WBGT	68.6	21-FEB-08	11:09:56																																																																																																																																																																																
DRY BULB	88.6	21-FEB-08	11:10:08																																																																																																																																																																																
GLOBE	93.0	21-FEB-08	11:10:03																																																																																																																																																																																
HEAT INDEX	0	00-XXX-00	00:00:00																																																																																																																																																																																
REL HUMIDITY	11%	21-FEB-08	11:07:32																																																																																																																																																																																
WBGT	71.4	21-FEB-08	11:10:14																																																																																																																																																																																
TIME	WBGT	DRY	GLOBE	RH	HI	FLOW	L	M	H	VH																																																																																																																																																																									
11:08	67.9	82.4	90.7	13	0	0.5	60	60	60	60																																																																																																																																																																									
11:09	68.1	82.6	91.3	12	0	0.5	60	60	60	60																																																																																																																																																																									
TIME	WBGT	DRY	GLOBE	RH	HI	L	M	H	VH																																																																																																																																																																										
11:08	79.3	98.9	104.5	15	0	60	45	30	15																																																																																																																																																																										
11:09	80.2	99.2	105.6	15	0	60	45	30	15																																																																																																																																																																										
TIME	WBGT	DRY	GLOBE	RH	HI	L	M	H	VH																																																																																																																																																																										
11:08	68.1	88.0	92.7	11	0	60	60	60	60																																																																																																																																																																										
11:09	68.4	88.3	92.9	11	0	60	60	60	60																																																																																																																																																																										
TIME	W-AVG	W-AVG	L	M	H	VH																																																																																																																																																																													
11:08	71.5	70.8	60	60	60	60																																																																																																																																																																													
11:09	71.8	71.1	60	60	60	45																																																																																																																																																																													

Figure 1-26: Report using parallel printer

Air Flow Functionality

(Available using TSI's Air Probe on QUESTemp° 46 model only)

Air flow is measured in meters per second over a range of 0 to 20m/s in 0.1m/s increments. The sensor should be placed or held perpendicular in the air stream. Unlike many anemometers, the omni-directional sensor does not require rotating to find the maximum reading. Be careful not to block the air flow with your body during measurements. The sensor's measuring tip is fragile; be cautious if measuring in ducts.

The Air Probe may be either hand-held or mounted behind the QUESTemp° 46 using the mounting bracket hooked to the sensor bar beneath the center bulb sensor. (See Figure 1-22 below.)

A green lamp indicator in the Air Probe indicates that it is turned on and the battery is good. If the green indicator turns off while the switch is in the **On** position, replace or recharge the battery.

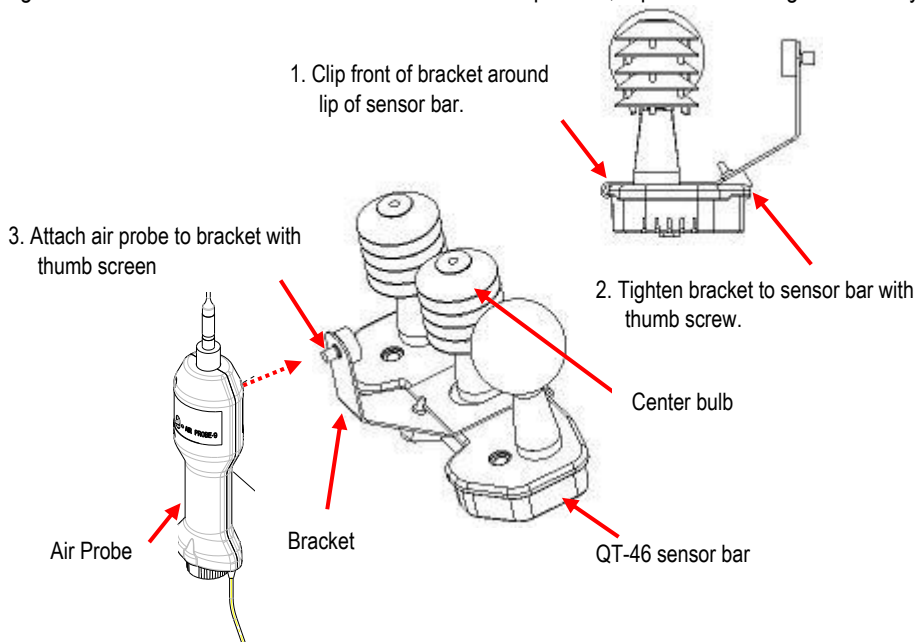

Figure 1-27: Air flow configuration

Operating Sequence

1. Turn **Flow On** in the setup menu of the QUESTemp[°]46.
2. Plug the Air Probe into the port labeled **Flow** on the side of the QUESTemp[°] 46.
3. Turn on the Air Probe **ON** and make sure the green lamp is lit.
 - In the View or Run modes, air flow is displayed on the fifth screen.

Data Logging Air Flow

To data log air flow in the QUESTemp[°] 46, the following two conditions must be met.

1. First, turn **Flow On** in the setup menu.
2. Second, make sure that a temperature sensor bar is connected to the Sensor 1 location (top) of the QUESTemp[°]46. Flow prints out with the Sensor 1 data therefore air flow data will only be reported if a sensor bar is plugged in. Air flow is recorded during the run mode at the interval the QUESTemp[°] 46 is setup for.

Batteries for Air Probe

The Air Probe uses a single NiMH Black&Decker® VersaPak™ Gold battery. Typical operating time of the battery is between 6 and 8 hours.

To change the battery, push in and twist, counterclockwise, the cap on the bottom of the Air Probe. Pull out the battery. Insert a fully charged battery and replace the cap.

To recharge the batteries, set the battery into the VersaPack™ charger. The supplied charger accepts one or two batteries. A full charge takes 9 hours. An indicator light shows that the battery is properly charging and it will remain on as long as the battery is in the charger. Continuous charging is not a safety concern.

Operational Check

A verification module, TSI model 053-923, may be used to check the operation of the QUESTemp. Remove the top sensor bar and plug the verification module into the top of the unit. With the QUESTemp set to read in degrees Celsius, verify that the displayed readings match those printed on the module within $\pm 0.5^{\circ}\text{C}$.

If the readings are not within the $\pm 0.5^{\circ}\text{C}$ tolerance, then have the unit serviced and calibrated.

Power Options

There are three options for powering the QUESTemp° 46: a 9-volt alkaline battery, a NiMH (Nickel Metal Hydride) rechargeable 6-cell battery pack, and an AC adapter. A door on the back of the unit allows the user access to the 9-volt battery. The rechargeable battery pack is located inside of the unit. If the rechargeable battery pack ever needs to be replaced, it can be accessed by removing the screws from the bottom panel of the unit.

The two-position switch located in the battery compartment must be set by the user if the power supply method is changed. The up position is for the 9-volt battery. The down position allows for either the AC adapter or the rechargeable batteries. The AC adapter will trickle charge the rechargeable batteries if they are in place or it will simply allow for line power operation of the unit.



Figure 1-28: 9-volt battery

9-Volt Alkaline Battery Replacement



WARNING: Replace batteries only in a non-hazardous environment.

The 9-volt battery should be replaced or the NiMH battery pack should be recharged when the voltage drops below 6.4 volts. The battery voltage is displayed when the instrument is turned on. While turned on, the battery voltage can be displayed at any time by pressing the up or down arrow keys to move through the display until the battery voltage screen appears. If, while operating, the battery voltage drops below 6.4 volts, the display will automatically switch to the display showing the battery voltage along with a low battery message. After a low battery occurs, the unit will continue to operate for approximately 8 hours. When the battery voltage falls to 6.2 volts or below, the unit will automatically turn off.

Replace only with an approved 9-volt alkaline battery.

Approved 9-Volt Batteries

Energizer: Energizer 522, EN22, 6LR61

Duracell: MN1604

Panasonic: 6LR61, 6AM6X

Rayovac: A1604

UltraLife: U9V

NiMH Battery Pack



WARNING: Replace batteries only in a non-hazardous environment.

The NiMH rechargeable battery pack is charged in the instrument using TSI's AC 120V AC to 9V DC adapter (part #015-910) or 220V AC to 9V DC adapter (part #015-680). A discharged battery pack requires an "overnight" charge of 16 hours (for the 120V adapter). Leaving the AC adapter plugged in for extended lengths of time or when operating the instrument will not harm the rechargeable batteries.

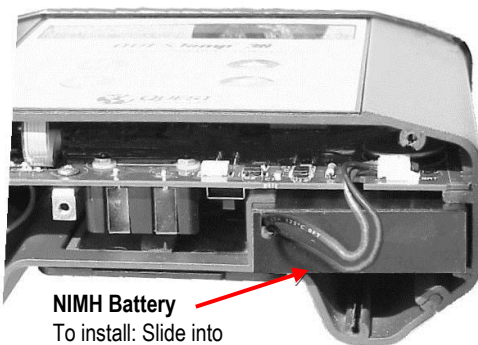

NiMH Battery

To install: Slide into case and plug in connector as shown.

Figure 1-29: NiMH rechargeable battery

Appendix A: Specifications

Measurements

- Globe temperature, dry bulb temperature, wet bulb temperature, % relative humidity, WBGT_{in}, WBGT_{out}, WBGT weighted average (if 3 sensor sets), and Heat Index / Humidex.
- Temperatures given in Celsius or Fahrenheit.
- Index (QT⁴⁶ only): ACGIH TLV, U.S. Navy PHEL Charts, Flag Conditions for U.S. Navy/Marine Corp. Ashore, and EPRI

Data Logging

- Records and prints all measurements at user selected interval of 1, 2, 5, 10, 15, 30, or 60 minutes. 128K bytes of data memory.

Languages

- English, French, Spanish, Italian, German

Housing

- Designed water resistant to a light rain or mist. If rain is frequent, best practice would be to remote the sensor bar and keep the instrument sheltered.

Size

- Height 9.2 in. (23.5 cm); Width 7.2 in. (18.3 mm); Depth 3.0 in. (7.5 mm)
- Dimensions include mounted sensor assembly

Weight

- 2.6 lbs. (1.2 kg) with mounted sensor assembly

Sensor Types

- Temperature: 1000 ohm platinum RTD
- Humidity: Integrated circuit with capacitive polymer sensor

Accuracy

- Dry Bulb and Globe Temperature: $\pm 0.5^{\circ}\text{C}$ between 0°C and 120°C
- Waterless Wet Bulb Temperature: Expanded measurement uncertainty of 1.1°C ($k=2$) between 0°C and 80°C
- Relative humidity: $\pm 5\%$ between 20 to 95% (non-condensing)

Operating Temperature Range

- Sensor Assembly: -5°C to +100°C
- Electronics: -5°C to 60°C

Remote Sensor Bars

- 2 x 15 pin D-sub jacks are located on the side of the unit for plugging in 1 or 2 additional sensor bars by using remote cables up to 200 feet (61 m). The top sensor bar can also be remote with a cable.

Power Options

- 9V alkaline, 7.2V NiMH rechargeable pack (charged in the unit), or AC adapter wall power cube (AC adaptor will operate the unit or recharge the NiMH battery pack)

Battery Life

- 9V alkaline: 80 hours
- Rechargeable Nickel Metal Hydride: 160 hours
- (Adding additional sensor bars reduces battery life.)

Charge Time (NiMH Battery Pack)

- 16 hours (charge in the unit)

Air Probe Accessory

- Range: 0 - 20 meters per second. 0.1 m/s increments
- Sensor: Omni directional heated thermistor
- Accuracy: $\pm(0.1 \text{ m/s} + 4\%)$ of measurement value
- Battery Life: 6 - 8 hours for fully charged NiMH battery
- Charge Time: 9 hours

Appendix B: Heat Exposure Tables

ACGIH

Screening Criteria for Heat Stress Exposure. WBGT values in °C.

NOTE: According to the ACGIH's guidelines, the temperature values represent a work and rest process which is explained in the standards. Refer to the ACGIH TLVs and BEIs for specific details.

Work and recovery (TLV)	Light	Moderate	Heavy	Very Heavy
75% to 100%	31.0	28.0	26.0*	23.5*
50% to 75%	31.0	29.0	27.5	25.5*
25% to 50%	32.0	30.0	29.0	28.0
0% to 25%	32.5	31.5	30.5	30.0

Work and recovery (Action Limit)	Light	Moderate	Heavy	Very Heavy
75% to 100%	28.0	25.0	22.5*	20.0*
50% to 75%	28.5	26.0	24.0	22.5*
25% to 50%	29.5	27.0	25.5	24.5
0% to 25%	30.0	29.0	28.0	27.0

*Values not specified by ACGIH have been estimated for continuity.

ACGIH Clothing Corrections

The following clothing corrections are in degrees Celsius. When a clothing correction is entered into the setup portion of the QUESTemp[®] 46, the value is added to the WBGT only for looking up the stay times. The WBGT value displayed by the unit does not reflect corrections.

Clothing type	Clothing correction (Addition to WBGT (°C))
Work clothes (long sleeve shirt and pants)	0°
Cloth (woven material) coveralls	0°
Double-layer woven clothing	3°
SMS polypropylene coveralls	0.5°
Polyolefin coveralls	1°
Limited-use vapor-barrier coveralls	11°

Cited from "American Conference of Governmental Industrial Hygienists - Threshold Limit Values and Biological Exposure Indices for 2008"; Reprinted with permission from ACGIH

United States Navy

Physiological Heat Exposure Limits (PHEL) Time Table
(Without the presence of fuel combustion gases/fuel vapors)

The recommended working hours are shown based on a maximum of eight hours. Naval personnel will follow a category, I - VI, based upon their function.

PHEL Curves (Total Exposure Time in Hours: Minutes)

WBGT(F)	I	II	III	IV	V	VI
80.0	>8:00	>8:00	>8:00	8:00	6:35	4:30
81.0	>8:00	>8:00	>8:00	8:00	6:35	4:30
82.0	>8:00	>8:00	8:00	7:05	5:25	3:40
83.0	>8:00	8:00	7:45	6:25	4:55	3:20
84.0	>8:00	8:00	7:05	5:55	4:30	3:05
85.0	8:00	7:45	6:30	5:20	4:05	2:50
86.0	8:00	7:05	5:55	4:55	3:45	2:35
87.0	7:25	6:30	5:25	4:30	3:25	2:20
88.0	6:45	5:55	4:55	4:05	3:10	2:10
89.0	6:10	5:25	4:30	3:45	2:50	2:00
90.0	5:40	5:00	4:10	3:25	2:40	1:50
91.0	5:15	4:35	3:50	3:10	2:25	1:40
92.0	4:50	4:10	3:30	2:55	2:15	1:30

WBGT(F)	I	II	III	IV	V	VI
93.0	4:25	3:50	3:15	2:40	2:00	1:25
94.0	4:05	3:35	3:00	2:25	1:50	1:15
95.0	3:45	3:15	2:45	2:15	1:45	1:10
96.0	3:25	3:00	2:30	2:05	1:35	1:05
97.0	3:10	2:45	2:20	1:55	1:25	1:00
98.0	2:55	2:35	2:10	1:45	1:20	0:55
99.0	2:40	2:20	2:00	1:40	1:15	0:50
100.0	2:30	2:10	1:50	1:30	1:10	0:45
101.0	2:20	2:00	1:40	1:25	1:05	0:45
102.0	2:10	1:50	1:35	1:15	1:00	0:40
103.0	2:00	1:45	1:25	1:10	0:55	0:35
104.0	1:50	1:35	1:20	1:05	0:50	0:35
105.0	1:40	1:30	1:15	1:00	0:45	0:30
106.0	1:35	1:25	1:10	0:55	0:45	0:30
107.0	1:30	1:15	1:05	0:50	0:40	0:25
108.0	1:20	1:10	1:00	0:50	0:35	0:25
109.0	1:15	1:05	0:55	0:45	0:35	0:25
110.0	1:10	1:00	0:50	0:40	0:30	0:20
111.0	1:05	1:00	0:50	0:40	0:30	0:20
112.0	1:00	0:55	0:45	0:35	0:25	0:20
113.0	0:55	0:50	0:40	0:35	0:25	0:15
114.0	0:55	0:45	0:40	0:30	0:25	0:15
115.0	0:50	0:45	0:35	0:30	0:20	0:15
116.0	0:45	0:40	0:35	0:25	0:20	0:15
117.0	0:45	0:40	0:30	0:25	0:20	0:10
118.0	0:40	0:35	0:30	0:25	0:15	0:10
119.0	0:35	0:35	0:25	0:20	0:15	0:10
120.0	0:35	0:30	0:25	0:20	0:15	0:10
121.0	0:35	0:30	0:25	0:20	0:15	0:10
122.0	0:30	0:25	0:20	0:15	0:15	0:10
123.0	0:30	0:25	0:20	0:15	0:10	0:10
124.0	0:25	0:25	0:20	0:15	0:10	0:05

Flag Conditions for U.S. Navy/Marine Corp. Ashore

The following chart details the heat stress monitoring Flag Conditions for U.S. Navy/Marine Corp. Ashore in Degrees Fahrenheit and Celsius.

	No Flag	Green	Yellow	Red	Black
Flag Degrees F	<80.0	80.0-84.9	85.0-87.9	88.0-89.9	>90
Flag Degrees C	<26.7	26.7-29.4	29.4-31.1	31.1-32.2	>32.2

*Rest means minimal physical activity (sitting or standing) and should be accomplished in the shade if possible.

Electrical Power Research Institute (EPRI)

The recommended working hours are shown based on a maximum of four hours. A time of 4:01 indicates greater than 4 hours.

WBGT°C	Light	Moderate	Heavy
28	4:01	4:01	3:00
29	4:01	4:00	2:00
30	4:01	3:00	1:30
31	4:01	2:00	1:15
32	4:00	1:30	1:00
33	3:30	1:15	0:45
34	3:00	1:00	0:40
35	2:30	0:53	0:35
36	2:00	0:45	0:30
37	1:45	0:40	0:25
38	1:30	0:35	0:20
39	1:15	0:33	0:18
40	1:00	0:30	0:15
41	0:53	0:28	0
42	0:45	0:25	0
43	0:38	0:23	0
44	0:30	0:20	0
45	0:28	0:18	0
46	0:25	0:15	0
47	0:23	0	0
48	0:20	0	0
49	0:18	0	0
50	0:15	0	0

Appendix C: Accessories

Sensor array with 2-inch globe	057-902
6-foot shielded remote sensor cable	053-924
25-foot shielded remote sensor cable	053-925
100-foot shielded remote sensor cable	053-926
200-foot shielded remote sensor cable	053-927
Serial computer cable.....	054-715
Parallel printer cable.....	056-875
120 VAC to 9 VDC adapter.....	015-910
220 VAC to 9 VDC adapter.....	015-680
Verification module	053-923
Tripod	059-045
User's manual.....	053-664

Air Probe Accessories

NiMH battery	53-039
Dual 120 volt charger	53-037
Dual 220 volt charger	53-038

Appendix D: TSI Detection Management Software DMS

The focus of this section is to briefly introduce the following DMS topics: downloading data, setting up parameters, and viewing data in charts, graphs, and reports. All data may be stored and saved in the software for record retention and/or for historical analysis. (For further details on DMS, refer to the online Help and select Contents.)

The QT^o 44/46 instruments are used for measuring occupational heat stress. The following sections explain communicating with the QUESTempo^o and DMS, saving and sending configurations, downloading, viewing data, setup, firmware updates, and printing reports.

QUESTempo^o 44/46

The QT^o 44/46 instruments are used for measuring occupational heat stress. The following sections explain communicating with the QUESTempo^o and DMS, saving and sending configurations, downloading, viewing data, setup, firmware updates, and printing reports.

Communication Setup

The communication setup is an important starting point with your instrument and DMS. Once communicating, you have the option to download data, configure instrument parameters and use quick setup features for time and date settings. The following explains the QT^o 44/46 communication setup steps.



1. Using a TSI cable, part number 054-715, plug the cable into the computer and plug the opposite end into the side jack of the QT^o 44/46 data port.

QT^o 44/46 data port

- Connected and powered on



Figure 1-30: Communicating with the QT^o 44/46 and DMS

2. From the start page of DMS, select the  or  buttons and the instrument communication panel will appear.
3. Select **Heat Stress** and then select the **Model Type** by clicking on **QT°44** or **QT°46**. (See **1** and **2**). (You are now ready to setup or download your instrument.)
4. Once selected, see the following sections for downloading or setup parameters to learn more about working with the QT° 44/46.
 - See the subsequent QT°44/QT°46 instrument setup sections to setup or download your instrument.

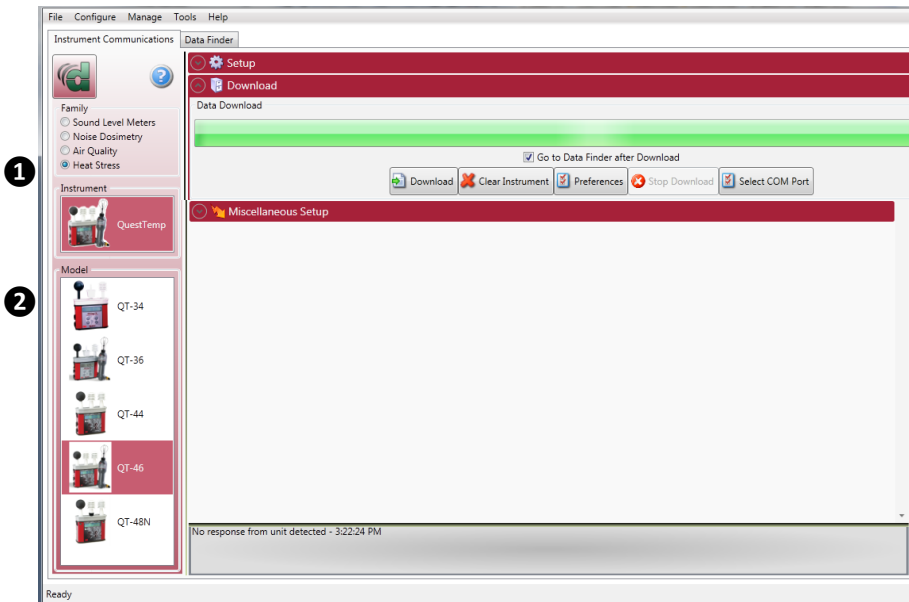



Figure 1-31: QT°44/46 downloading data

- NOTE:** The first time you communicate with the QUESTemp° and DMS the Found New Hardware wizard will appear. Install and follow the screen prompts.

Downloading Data with the QT⁰44/46

The Instrument Download feature is used to download your files from the QT⁰44/46 into the software for review and analysis of the data. Once the files are downloaded and if “Go to Data Finder after Download” is checked, DMS will open into the Data Finder window. (**Note:** The Data Finder window stores all of the downloaded data by instrument, session and study. The information is stored in a bar chart style with measurements/parameters displayed on the top navigational bar. To download, follow steps below:

1. To download the QT⁰ 44/46 data, ensure your instrument is communicating properly. (See communication setup for details.)
2. From the Start page, select the  button.
3. Select the **Heat Stress** Family and select the appropriate QT⁰ 44/46 model from the Instrument window (see **1** and **2**).
4. *Optional:* click on the “Go to Data Finder after download” checkbox if you want to view your session/study information after the download (see **3**).
5. Press the **Download** button (see **4**).

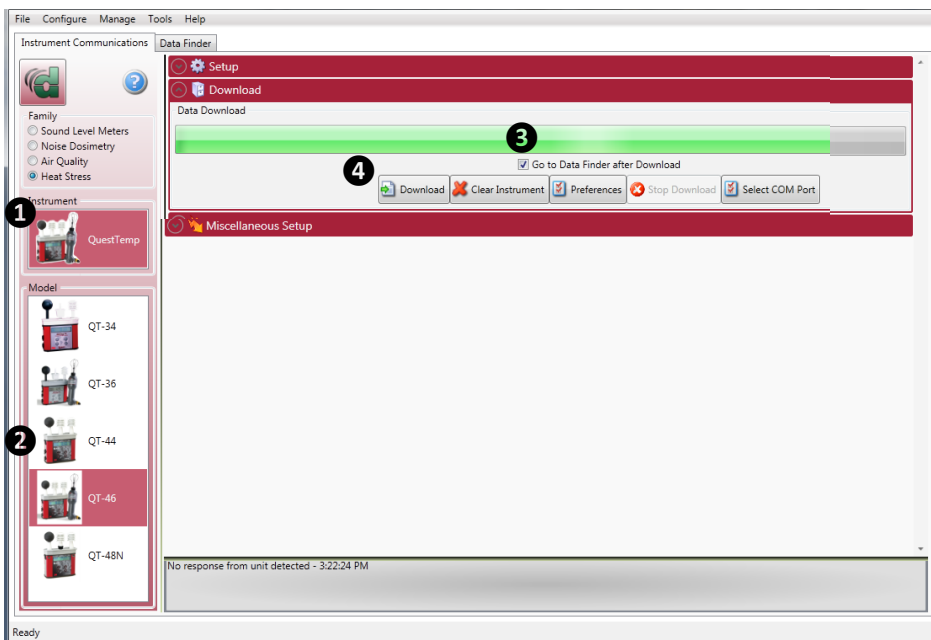



Figure 1-32: Downloading QT⁰44/46 files

Viewing Data in DMS

The following section outlines viewing your data with the QT^o 44/46 models.

Selecting a Session/Study

To view downloaded data from the welcome page, click on the  button and the data finder screen will appear. (Or select the **Data Finder** tab if already opened.)

1. Select a session by either double-clicking on data or click on the session/study and select the  button. (**NOTE:** The example below illustrates a session selected with a run time of 3 minutes.) (See **1**).

 - **Family: Heat Stress:** QT^o44/46 data is stored in this family. (See **2**).
 - **Session/Study:** The QT^o44/46 data is organized by the table headings, such as the session/study name (See **3**).
 - **Start Time:** To quickly locate your study by most recent start time, click on the **Start Time** heading and it will sort ascending/descending (See **4**).
 - **Parameters & measurements:** The table headings and columns are customizable by a quick click, drag, and drop to a new column location (similar to Microsoft[®] Excel[®] spreadsheet program.)

Double-click to select/view QT^o44/46 data in charts and graphs

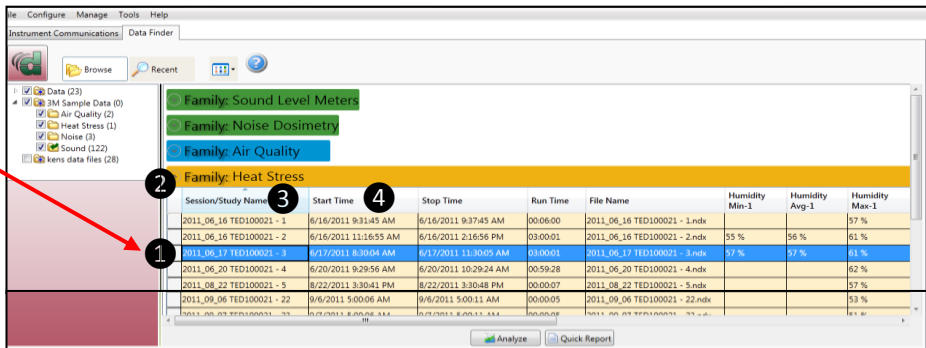

Session/Study Name	Start Time	Stop Time	Run Time	File Name	Humidity Min-1	Humidity Avg-1	Humidity Max-1
2011_06_16 TED100021 - 1	6/16/2011 9:31:45 AM	6/16/2011 9:37:45 AM	00:06:00	2011_06_16 TED100021 - 1.ndx			57 %
2011_06_16 TED100021 - 2	6/16/2011 11:16:55 AM	6/16/2011 2:16:56 PM	03:00:01	2011_06_16 TED100021 - 2.ndx	55 %	56 %	61 %
2011_06_17 TED100021 - 3	6/17/2011 8:30:04 AM	6/17/2011 11:30:05 AM	03:00:01	2011_06_17 TED100021 - 3.ndx	57 %	57 %	61 %
2011_06_20 TED100021 - 4	6/20/2011 9:29:56 AM	6/20/2011 10:29:24 AM	00:59:28	2011_06_20 TED100021 - 4.ndx			62 %
2011_08_22 TED100021 - 5	8/22/2011 3:30:41 PM	8/22/2011 3:30:48 PM	00:00:07	2011_08_22 TED100021 - 5.ndx			57 %
2011_09_06 TED100021 - 22	9/6/2011 5:00:06 AM	9/6/2011 5:00:11 AM	00:00:05	2011_09_06 TED100021 - 22.ndx			53 %

Figure 1-33: Selecting a session

Charts and Graphs in Panel layout view (PLV) page

The measurements and parameters will be displayed in charts and graphs which may be customized for analysis and/or reporting purposes.

- **Note:** A  button provides a quick link to viewing the panel layout view data in a report format.
1. In the PLV page, it is divided into Work Items (see **1**), Add panel (see **2**), Arrange Panels (see **C**) and Data Panels (see **D**).
 - **Work items 1** – select either the session or study (in order to view appropriate measurement/parameter data).
 - **Add panel 2** – double-click on a chart/table type and it will appear as a panel on your screen.
 - **Arrange panels 3** – displays the order of the charts/tables which appear in the panel layout. Also, when a chart/table is selected in the arrange panels palette, the associated data panel is selected. The resize handles are applied and the panel is brought into view. (This is very useful when several panels are displayed.) To delete a panel, right-click on a chart/table and press delete from your keyboard.
 - **Data panels 4** – used to view your measurement and/or parameters from your study. Note: use the menu bar icons and/or configure icon to customize parameters.
 - **Toolbar and Configure button 5** – the toolbar and configure button are used to customize or select different measurement parameters.

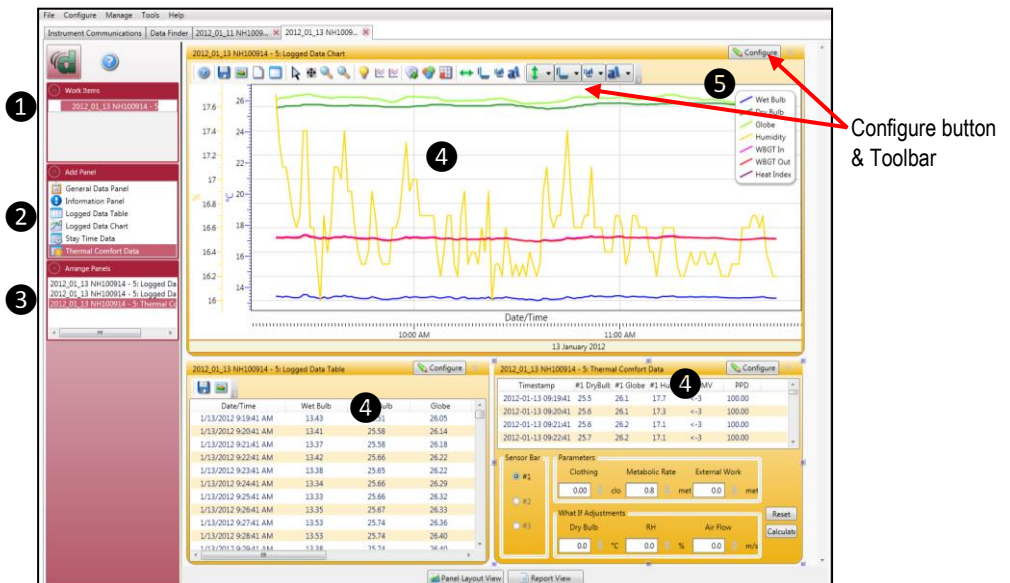

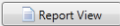

Figure 1-34: QT[®]44/46 data in panel layout view

2. To change the graph/table data parameters, click on the  button. Each graph/table may have different configurable parameters depending on the parameters applicable to the specific panel.
3. To view the data as a report, click the  button. (Note: the panels will print in the order in which they are displayed in the panel layout page.)
4. The quick tips below explain how to customize the panels and/or graphs/tables:
 - **To stretch the graph/tables**, click on one the corner's edge of a chart or table and drag the mouse. (Note: selection handles will appear.) The graph/table will expand or shrink when resizing.
 - **To move the graph**, click, drag and drop to the appropriate panel position.
 - **To change ranges**, when clicking on either the x-axis or y-axis, click and drag the mouse until the appropriate range is selected. (**NOTE:** It will span the numbers up or down depending on how you drag the mouse.)
 - **To save a layout**, Right-click outside the tables/graphs area as displayed below. Click **Remember Setting**.

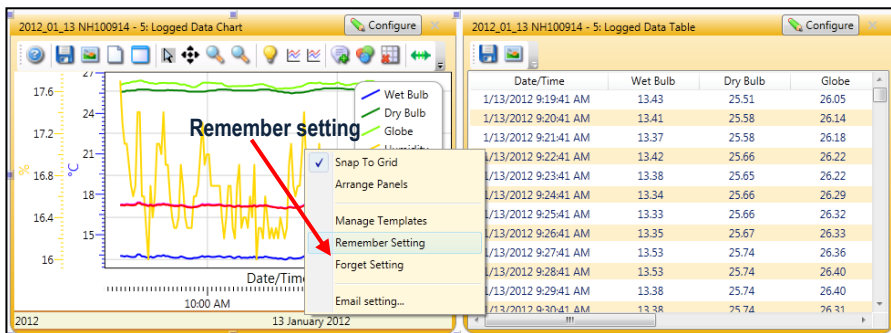





Figure 1-35: Rearranging panels and saving layout

Reports and Printing

To quickly create reports, open your data (in the data finder page) and click the quick report  button. A standard template of charts and graphs (or panels) will appear in the report.

- **Viewing reports:** if you are in the data layout page and you have rearranged the charts/tables, the report will print in the sequence in which they appear on the screen.
- **Printing reports:** while in the report view page you have two options outlined below:
 - Click on the  icon from the title bar.
 - Click on the  icon from the session report title bar.

Customize the report by inserting on-site testing images

Session Report
1/13/2012

Description	Meter	Value	Description	Meter	Value
Wet Bulb Max	SensorBar 1	13.6 °C	Wet Bulb Avg	SensorBar 1	13.34 °C
Wet Bulb Min	SensorBar 1	10.15 °C	Wet Bulb Max Time	SensorBar 1	1/13/2012 9:28:14 AM
Wet Bulb Min Time	SensorBar 1	1/13/2012 10:39:41 AM	Dry Bulb Max	SensorBar 1	25.89 °C
Dry Bulb Avg	SensorBar 1	25.89 °C	Dry Bulb Min	SensorBar 1	25.45 °C
Dry Bulb Max Time	SensorBar 1	1/13/2012 11:17:19 AM	Dry Bulb Min Time	SensorBar 1	1/13/2012 10:30:41 AM
Globe Max	SensorBar 1	26.42 °C	Globe Avg	SensorBar 1	26.09 °C
Globe Min	SensorBar 1	25.77 °C	Globe Max Time	SensorBar 1	1/13/2012 11:14:50 AM
Globe Min Time	SensorBar 1	1/13/2012 11:34:41 AM	WBGT In Max	SensorBar 1	17.44 °C
WBGT In Avg	SensorBar 1	17.17 °C	WBGT In Min	SensorBar 1	14.95 °C
WBGT In Max Time	SensorBar 1	1/13/2012 9:28:14 AM	WBGT In Min Time	SensorBar 1	1/13/2012 10:30:41 AM

Logged Data Chart

2012_01_13 NH100914 - 5: Logged Data Chart

Legend: Wet Bulb, Dry Bulb, Globe, Humidity, WBGT In, WBGT Out, Wind Speed

Panel Layout View | Report View

Figure 1-36: Sample QT⁴⁶ report

Contact/Service information

This section gives directions for contacting TSI Incorporated for technical information and directions for returning the QUESTemp° 44/46 for service.

Technical Support Contacts

If you have any difficulty setting or operating the instrument, or if you have technical or application questions about this system, contact TSI's Technical Support.

North America and Asia Pacific	Europe, Middle East, and Africa
Telephone: 1-800-680-1220 (USA); +1 651-490-2860 (Outside USA)	Telephone: +49 241-52303-0
Fax: +1 651-490-3824	Fax: +49 241 52303-49
E-mail: technical.services@tsi.com	E-mail: tsigmbh@tsi.com

Service Contact Information

If your instrument does not operate properly, or if you are returning the instrument for service, visit our website at <http://rma.tsi.com> for a Return Material Authorization, or contact Customer Service.

North America and Asia Pacific	Europe, Middle East, and Africa
TSI Incorporated 1060 Corporate Center Drive Oconomowoc, WI 53006-4828	TSI Instruments Ltd. Stirling Road Cressex Business Park High Wycombe, Bucks HP12 3ST United Kingdom
Telephone: 1-800-680-1220 (USA); +1 651-490-2860 (Outside USA)	Telephone: +44 (0) 149 4 459200
E-mail: technical.services@tsi.com	E-mail: tsiuk@tsi.com

Returning for Service

Visit our website at <http://rma.tsi.com> and complete the on-line “Return Merchandise Authorization” form or call TSI at 1-800-680-1220 (USA) or (651) 490-2860, or 001 651 490 2860 (International) for specific return instructions.

Customer Service will need the following information:

- The instrument model number
- The instrument serial number
- A purchase order number (unless under warranty)
- A billing address
- A shipping address

Use the original packing material to return the instrument to TSI. If you no longer have the original packing material, seal off any ports to prevent debris from entering the instrument and ensure that the display and the connectors on the instrument front and back panels are protected. This instrument is very fragile and must be packed in a manner appropriate for a precision instrument.

Calibration

The QUESTemp[®] 44/46 heat stress monitor and TSI field calibrator devices should be examined regularly by the factory. An annual calibration is recommended. (See Service Information above.)

Warranty

(For country-specific terms and conditions outside of the USA, please visit www.tsi.com.)

Seller warrants the goods, excluding software, sold hereunder, under normal use and service as described in the operator's manual, to be free from defects in workmanship and material for **12 months**, or if less, the length of time specified in the operator's manual, from the date of shipment to the customer. This warranty period is inclusive of any statutory warranty. This limited warranty is subject to the following exclusions and exceptions:

- a. Hot-wire or hot-film sensors used with research anemometers, and certain other components when indicated in specifications, are warranted for 90 days from the date of shipment;
- b. Pumps are warranted for hours of operation as set forth in product or operator's manuals;
- c. Parts repaired or replaced as a result of repair services are warranted to be free from defects in workmanship and material, under normal use, for 90 days from the date of shipment;
- d. Seller does not provide any warranty on finished goods manufactured by others or on any fuses, batteries or other consumable materials. Only the original manufacturer's warranty applies;
- e. This warranty does not cover calibration requirements, and seller warrants only that the instrument or product is properly calibrated at the time of its manufacture. Instruments returned for calibration are not covered by this warranty;
- f. This warranty is **VOID** if the instrument is opened by anyone other than a factory authorized service center with the one exception where requirements set forth in the manual allow an operator to replace consumables or perform recommended cleaning;
- g. This warranty is **VOID** if the product has been misused, neglected, subjected to accidental or intentional damage, or is not properly installed, maintained, or cleaned according to the requirements of the manual. Unless specifically authorized in a separate writing by Seller, Seller makes no warranty with respect to, and shall have no liability in connection with, goods which are incorporated into other products or equipment, or which are modified by any person other than Seller.

The foregoing is **IN LIEU OF** all other warranties and is subject to the LIMITATIONS stated herein. **NO OTHER EXPRESS OR IMPLIED WARRANTY OF FITNESS FOR PARTICULAR PURPOSE OR MERCHANTABILITY IS MADE. WITH RESPECT TO SELLER'S BREACH OF THE IMPLIED WARRANTY AGAINST INFRINGEMENT, SAID WARRANTY IS LIMITED TO CLAIMS OF DIRECT INFRINGEMENT AND EXCLUDES CLAIMS OF CONTRIBUTORY OR INDUCED INFRINGEMENTS. BUYER'S EXCLUSIVE REMEDY SHALL BE THE RETURN OF THE PURCHASE PRICE DISCOUNTED FOR REASONABLE WEAR AND TEAR OR AT SELLER'S OPTION REPLACEMENT OF THE GOODS WITH NON-INFRINGEMENT GOODS.**

TO THE EXTENT PERMITTED BY LAW, THE EXCLUSIVE REMEDY OF THE USER OR BUYER, AND THE LIMIT OF SELLER'S LIABILITY FOR ANY AND ALL LOSSES, INJURIES, OR DAMAGES CONCERNING THE GOODS (INCLUDING CLAIMS BASED ON CONTRACT, NEGLIGENCE, TORT, STRICT LIABILITY OR OTHERWISE) SHALL BE THE RETURN OF GOODS TO SELLER AND THE REFUND OF THE PURCHASE PRICE, OR, AT THE OPTION OF SELLER, THE REPAIR OR REPLACEMENT OF THE GOODS. IN THE CASE OF SOFTWARE, SELLER WILL REPAIR OR REPLACE DEFECTIVE SOFTWARE OR IF UNABLE TO DO SO, WILL REFUND THE PURCHASE PRICE OF THE SOFTWARE. IN NO EVENT SHALL SELLER BE LIABLE FOR LOST PROFITS, BUSINESS INTERRUPTION, OR ANY SPECIAL, INDIRECT, CONSEQUENTIAL OR INCIDENTAL DAMAGES. SELLER SHALL NOT BE RESPONSIBLE FOR INSTALLATION, DISMANTLING OR REINSTALLATION COSTS OR CHARGES. No Action, regardless of form, may be brought against Seller more than 12 months after a cause of action has accrued. The goods returned under warranty to Seller's factory shall be at Buyer's risk of loss, and will be returned, if at all, at Seller's risk of loss.

Buyer and all users are deemed to have accepted this LIMITATION OF WARRANTY AND LIABILITY, which contains the complete and exclusive limited warranty of Seller. This LIMITATION OF WARRANTY AND LIABILITY may not be amended, modified or its terms waived, except by writing signed by an Officer of Seller.

Service Policy

Knowing that inoperative or defective instruments are as detrimental to TSI as they are to our customers, our service policy is designed to give prompt attention to any problems. If any malfunction is discovered, please contact your nearest sales office or representative, or call TSI's Customer Service department at 1-800-874-2811 (USA) or +001 (651) 490-2811 (International).



TSI Incorporated – Visit our website www.tsi.com for more information.

USA **Tel:** +1 800 874 2811
UK **Tel:** +44 149 4 459200
France **Tel:** +33 1 41 19 21 99
Germany **Tel:** +49 241 523030

India **Tel:** +91 80 67877200
China **Tel:** +86 10 8219 7688
Singapore **Tel:** +65 6595 6388

